



Preface

Memorandum
 List of Acronyms _____ i
 List of Figures _____ ii
 Foreword _____ iii
 Introduction _____ iv

Chapter 1 ♦ HOV Planning

1.1 General _____ 1-1
 1.2 HOV Statutes and Policies _____ 1-2
 1.3 HOV Planning _____ 1-3

Chapter 2 ♦ HOV Operations

2.1 General _____ 2-1
 2.2 Modes of Operation _____ 2-1
 2.3 Queue Bypasses _____ 2-2
 2.4 Hours of Operation _____ 2-3
 2.5 Vehicle Occupancy _____ 2-4
 2.6 Vehicle Types _____ 2-4
 2.7 Deadheading _____ 2-5
 2.8 Incident Handling/Special Events
 on HOV Lanes _____ 2-5
 2.9 Using HOV Lanes for Traffic
 Management Plans _____ 2-6
 2.10 Passing Lanes _____ 2-6
 2.11 Transit Stations _____ 2-6

Chapter 3 ♦ HOV Geometric Design

3.1 General _____ 3-1
 3.2 General Design Criteria _____ 3-2
 3.3 Geometric Configurations _____ 3-3
 3.4 Barrier-Separated
 HOV Facilities _____ 3-3
 3.5 Buffer-Separated
 HOV Facilities _____ 3-4
 3.6 Contiguous HOV Facilities _____ 3-4
 3.7 HOV Direct Connectors _____ 3-8
 3.8 HOV Drop Ramps _____ 3-9
 3.9 Local Obstructions _____ 3-9
 3.10 Relative Priority of
 Cross-Sectional Elements _____ 3-14
 3.11 On-Line Bus Facilities _____ 3-15

Chapter 4 ♦ HOV Ingress and Egress

4.1 Beginning and Termination
 Points _____ 4-1
 4.2 Ingress/Egress for Barrier-
 Separated HOV Facilities _____ 4-2
 4.3 Ingress/Egress for Buffer-
 Separated HOV Facilities _____ 4-2
 4.4 Ingress/Egress for Contiguous
 HOV Facilities _____ 4-3

Chapter 5 ♦ HOV Signs and Markings

5.1 General _____ 5-1
 5.2 HOV Signs _____ 5-2
 5.3 HOV Markings _____ 5-3
 HOV Details M-1 to M-11 _____ 5-4
 HOV Sign Specifications _____ 5-15

CH-5 Appendix A:

US Shields on Guide Signs _____ 5A-1
 Interstate Shields Used
 on Guide Signs _____ 5A-3
 State Route Shields Used
 on Guide Signs _____ 5A-5
 Standard Arrowhead for
 Warning & Regulatory Signs _____ 5A-7
 Standard Arrows for
 Directional Signs _____ 5A-8

CH-5 Appendix B:

HOV Sign Policy Statements _____ 5B-1

Chapter 6 ♦ HOV Enforcement

6.1 General _____ 6-1
 6.2 Role of Enforcement _____ 6-1
 6.3 Violation Rates _____ 6-1
 6.4 Enforcement Alternatives _____ 6-2
 6.5 Other Enforcement
 Considerations _____ 6-3

Appendix

HOV Statutes and Policies _____ Appendix A
 HOV Report Guidelines _____ Appendix B

HIGH-OCCUPANCY VEHICLE GUIDELINES

for Planning, Design
and Operations

August 2003

State of California
Business, Transportation
and Housing Agency



Prepared by:
Department of Transportation
Division of Traffic Operations

web address: <http://onramp/hq/trafops/otrafopr/hov/hov.html>



This guidance was prepared by the California Department of Transportation (Caltrans) Headquarters, Division of Traffic Operations, High-Occupancy Vehicle Systems Branch, 1120 N Street, Sacramento, California 95814.

This guidance is an update of the July 1991 Guidelines for Planning, Design and Operations of High-Occupancy Vehicle (HOV) facilities. It provides statewide uniformity of the development of HOV facilities and details the areas of responsibility for implementation. All measures are expressed in metric units.

Questions and comments regarding information contained in this guidance can be directed to Antonette C. Clark, HOV Systems Branch Chief at (916) 653-4552.

web address: <http://onramp/hq/trafops/otrafopr/hov/hov.html>



Preface

Memorandum	
List of Acronyms	i
List of Figures	ii
Foreword	iii
Introduction	iv

Chapter 1 ♦ HOV Planning

1.1	General	1-1
1.2	HOV Statutes and Policies	1-2
1.3	HOV Planning	1-3

Chapter 2 ♦ HOV Operations

2.1	General	2-1
2.2	Modes of Operation	2-1
2.3	Queue Bypasses	2-2
2.4	Hours of Operation	2-3
2.5	Vehicle Occupancy	2-4
2.6	Vehicle Types	2-4
2.7	Deadheading	2-5
2.8	Incident Handling/Special Events on HOV Lanes	2-5
2.9	Using HOV Lanes for Traffic Management Plans	2-6
2.10	Passing Lanes	2-6
2.11	Transit Stations	2-6

Chapter 3 ♦ HOV Geometric Design

3.1	General	3-1
3.2	General Design Criteria	3-2
3.3	Geometric Configurations	3-3
3.4	Barrier-Separated HOV Facilities	3-3
3.5	Buffer-Separated HOV Facilities	3-4
3.6	Contiguous HOV Facilities	3-4
3.7	HOV Direct Connectors	3-8
3.8	HOV Drop Ramps	3-9
3.9	Local Obstructions	3-9
3.10	Relative Priority of Cross-Sectional Elements	3-14
3.11	On-Line Bus Facilities	3-15

Chapter 4 ♦ HOV Ingress and Egress

4.1	Beginning and Termination Points	4-1
4.2	Ingress/Egress for Barrier- Separated HOV Facilities	4-2
4.3	Ingress/Egress for Buffer- Separated HOV Facilities	4-2
4.4	Ingress/Egress for Contiguous HOV Facilities	4-3

Chapter 5 ♦ HOV Signs and Markings

5.1	General	5-1
5.2	HOV Signs	5-2
5.3	HOV Markings	5-3
	HOV Details M-1 to M-11	5-4
	HOV Sign Specifications	5-15

CH-5 Appendix A:

	US Shields on Guide Signs	5A-1
	Interstate Shields Used on Guide Signs	5A-3
	State Route Shields Used on Guide Signs	5A-5
	Standard Arrowhead for Warning & Regulatory Signs	5A-7
	Standard Arrows for Directional Signs	5A-8

CH-5 Appendix B:

	HOV Sign Policy Statements	5B-1
--	----------------------------	------

Chapter 6 ♦ HOV Enforcement

6.1	General	6-1
6.2	Role of Enforcement	6-1
6.3	Violation Rates	6-1
6.4	Enforcement Alternatives	6-2
6.5	Other Enforcement Considerations	6-3

Appendix

	HOV Statutes and Policies	Appendix A
	HOV Report Guidelines	Appendix B

AADT	Annual Average Daily Traffic	MTDB	Metropolitan Transit Development Board
AASHTO	American Association of State Highway and Transportation Officials	MTS	Metropolitan Transit System
AC	Asphalt Concrete	MUTCD	Manual on Uniform Traffic Control Devices
AHS	Advanced Highway Systems	NEPA	National Environmental Policy Act
AQMP	Air Quality Management Plan	NHS	National Highway System
ATMS	Advanced Traffic Management System	O&D	Origin and Destination
ATSD	Advanced Transportation System Development	OC	Overcrossing
AVR	Average Vehicle Ridership	OCTA	Orange County Transportation Authority
BT&H	Business, Transportation and Housing Agency	OCTC	Orange County Transportation Commission
CARB	California Air Resources Board	PCC	Portland Cement Concrete
CCAA	California Clean Air Act	PE	Project Engineer
CEQA	California Environmental Quality Act	PHV	Peak Hour Volume
CFR	Code of Federal Regulations	PM	Post-Mile
CHP	California Highway Patrol	PMS	Pavement Management System
CIP	Capital Improvement Program	PPH	Persons Per Hour
CMAQ	Congestion Mitigation and Air Quality	PR	Project Report
CMP	Congestion Management Program	PS&E	Plans, Specifications and Estimate
CMS	Changeable Message Sign	PSR	Project Study Report
CTC	California Transportation Commission	PSSR	Project Scope Summary Report
CTP	California Transportation Plan	PUC	Public Utilities Commission
CVC	California Vehicle Code	RCR	Route Concept Report
DOT	Department of Transportation	RFP	Request for Proposals
EIR	Environmental Impact Report	RTIP	Regional Transportation Improvement Plan
EIS	Environmental Impact Statement	RTPA	Regional Transportation Planning Agency
EPA	Environmental Protection Agency	RW	Right of Way
ETC	Electronic Toll Collection	SACOG	Sacramento Area Council of Governments
FCAA	Federal Clean Air Act	SANDAG	San Diego Association of Governments
FCR	Flexible Congestion Relief	SCAG	Southern California Association of Governments
FHWA	Federal Highway Administration	SHA	State Highway Account
FSP	Freeway Service Patrol	SHOPP	State Highway Operations and Protection Program
FTA	Federal Transit Administration	SIP	State Implementation Plan
HCM	Highway Capacity Manual	SSD	Stopping Sight Distance
HDM	Highway Design Manual	STAA	Surface Transportation Assistance Act
HNS	Highways of National Significance	STIP	State Transportation Improvement Program
HOT	High-Occupancy Toll	TASAS	Traffic Accident Surveillance Analysis System
HOV	High-Occupancy Vehicle	TCM	Transportation Control Measure
HTF	Highway Trust Fund	TCR	Transportation Concept Report
IC	Interchange	TDM	Transportation Demand Management
IGR	Intergovernmental Review	TDP	Transportation Development Plan
IRRS	Interregional Road System	TMA	Transportation Management Association
ISTEA	Intermodal Surface Transportation Efficiency Act	TMC	Transportation Management Center
ITS	Intelligent Transportation System	TMP	Transportation Management Plan
ITSP	Interregional Transportation Strategic Plan	TOS	Traffic Operations System
KP	Kilometer-Post	TRB	Transportation Research Board
LOS	Level of Service	TSM	Transportation Systems Management
LRT	Light Rail Transit	UC	Undercrossing
LTC	Local Transportation Commission	VMT	Vehicle Miles Traveled
MPO	Metropolitan Planning Organization	VPH	Vehicles Per Hour
MTC	Metropolitan Transportation Commission	VPHPL	Vehicles Per Hour Per Lane

Chapter 3 ♦ HOV Geometric Design

3.1	Typical Cross Sections Barrier-Separated HOV Facilities.....	3-5
3.2	Typical Cross Sections Buffer-Separated and Contiguous HOV Facilities.....	3-6
3.3	Typical Cross Sections HOV Direct Connector and Elevated HOV Facilities.....	3-7
3.4	Typical HOV Direct Connector Entrances and Exits.....	3-10
3.5	Typical Cross Sections HOV Drop Ramp to Overcrossing and Undercrossing.....	3-11
3.6	Typical HOV Drop Ramp Entrances and Exits.....	3-12
3.7	Median Barrier Transitions.....	3-13
3.8	Typical Layout and Cross Section HOV On-Line Bus Facilities.....	3-16

Chapter 4 ♦ HOV Ingress and Egress

4.1	Ingress/Egress for Barrier-Separated HOV Facilities.....	4-4
4.2	Weave Distance at Buffer-Separated HOV Facilities.....	4-5

Chapter 5 ♦ HOV Signs and Markings**Detail M-1**

Typical HOV Signs and Pavement Markings Begin HOV Buffer-Separated Facility.....	5-4
---	-----

Detail M-2

Typical HOV Signs and Pavement Markings Begin HOV Contiguous Facility, Full-Time Operation.....	5-5
--	-----

Detail M-3

Typical HOV Signs and Pavement Markings Begin HOV Contiguous Facility, Part-Time Operation.....	5-6
--	-----

Detail M-4

Typical HOV Signs and Pavement Markings Typical Ingress/Egress for HOV Facilities With Buffers 0.3m to 1.2m.....	5-7
--	-----

Detail M-5

Typical HOV Signs and Pavement Markings Typical Ingress/Egress for HOV Facilities With Buffers 3.6m or Wider.....	5-8
---	-----

Detail M-6

Typical HOV Signs and Pavement Markings Typical End HOV Lane.....	5-9
--	-----

Detail M-7

Typical HOV Signs and Pavement Markings Typical HOV Lane Pavement Marking for Buffer-Separated (Ingress/Egress) HOV Facilities.....	5-10
---	------

Detail M-8

Typical HOV Signs and Pavement Markings Typical HOV Lane Pavement Marking.....	5-11
---	------

Detail M-9

Typical HOV Signs and Pavement Markings Typical Pavement Marking Detail For Buffer-Separated HOV Facilities.....	5-12
--	------

Detail M-10

Typical HOV Signs and Pavement Markings Typical Pavement Marking Detail for HOV Facilities.....	5-13
--	------

Detail M-11

Typical HOV Signs and Pavement Markings Typical HOV Drop Ramp Signs and Pavement Markings.....	5-14
---	------

Sign G20-9	Guide Sign.....	5-15
Sign G83-3	Guide Sign.....	5-16
Sign G84-1	Guide Sign.....	5-17
Sign G85-7	Guide Sign.....	5-18
Sign G85-8	Guide Sign.....	5-19
Sign G85-9	Guide Sign.....	5-20
Sign G86-8	Guide Sign.....	5-21
Sign G86-9	Guide Sign.....	5-22
Sign G86-10	Guide Sign.....	5-23
Sign G92-1	Guide Sign.....	5-24
Sign R82-1	Regulatory Sign.....	5-25
Sign R82B	Regulatory Sign.....	5-26
Sign R84-1	Regulatory Sign.....	5-27
Sign R84-2	Regulatory Sign.....	5-28
Sign R86	Regulatory Sign.....	5-29
Sign R86-2	Regulatory Sign.....	5-30
Sign R86-3	Regulatory Sign.....	5-31
Sign R87-1	Regulatory Sign.....	5-32
Sign R87-2	Regulatory Sign.....	5-33
Sign R91-2	Regulatory Sign.....	5-34
Sign R93A	Regulatory Sign.....	5-35
Sign R93-2	Regulatory Sign.....	5-36
Sign SR50-1	Regulatory Sign.....	5-37
Sign SR50-2	Regulatory Sign.....	5-38
Sign W11-1	Warning Sign.....	5-39
Sign W59-1	Warning Sign.....	5-40
Sign W72B	Warning Sign.....	5-41
Sign W74-1	Warning Sign.....	5-42
Sign W75-1	Warning Sign.....	5-43

Chapter 6 ♦ HOV Enforcement

6.1	Bi-Directional Enforcement Areas For 6.7m Medians.....	6-4
6.2	Directional Enforcement Areas For 6.7m Medians.....	6-5
6.3	Enforcement Areas For Medians Less than 6.7m.....	6-6

Foreword

The High-Occupancy Vehicle (HOV) lane system is used as a cost-effective operational strategy to maximize the people-carrying capacity of freeways. HOV facilities are a proven multimodal operational strategy supported by the Federal Highway Administration (FHWA), and local and regional agencies to improve both the current and future mobility, productivity, and quality of travel associated with congested transportation corridors in metropolitan areas. Lastly, HOV lanes have been used as a viable alternative, and in most cases is the only alternative that meets the federal air quality conformity standards for capacity-increasing projects in metropolitan areas.



California's HOV lanes were initially considered as an innovative strategy, adding a bus-only lane during the reconstruction of the San Francisco-Oakland Bay Bridge in 1962. As traffic demand continued to exceed the capacity of many of the state's metropolitan freeways, the California Department of Transportation (Department) and its regional partners opened HOV lanes in the most heavily congested areas of the state; that is, where HOV lanes offered the greatest potential benefit. The statewide HOV system has grown from a segmented 260 lane-miles in 1990 to the current (December 2003) comprehensive system network in excess of 1,100 lane-miles, where lane-miles are directional miles.

For most situations, retrofitting an HOV lane on an existing freeway requires some compromises in design standards. Back in 1987, FHWA's Procedure Memorandum D6103 introduced, under certain conditions, exceptions to AASHTO design standards. But it offered little guidance on acceptable geometric reductions. This was not surprising considering HOV facilities were still a relatively new development and few design guidelines were available at the time. In 1989, in response to District requests for guidelines to provide statewide consistency and uniformity, the Division of Traffic Operations began preparing the initial guidelines. The Division staff organized and chaired a committee of representatives from the metropolitan Districts, several Headquarters Divisions, the CHP, FHWA and private consultants. Without exception, the continued participation and cooperation received from the committee members was outstanding. It is their contribution and dedication that made the update to these guidelines possible.



Introduction

These guidelines are not intended to supersede Caltrans' Transportation Planning Manual, Project Development Procedures Manual, Highway Design Manual, Manual on Uniform Traffic Control Devices (MUTCD) and California Supplement to the MUTCD (which replaces the Caltrans' Traffic Manual), or other inter-Department manuals, procedures or practices. These guidelines are not, and should not be used as a set of standards. The Guidelines are advisory in nature and are to be used only when every effort to conform to established standards has been exhausted. When conformance is not possible, the deviation must be documented by a sound and defensible analysis and an approved design exception fact sheet.

The goal of these guidelines is to provide a "how to" document for planners, designers and operators of mainline HOV facilities. *Since individual site characteristics vary, only typical, full standard design scenarios can be presented. For situations not discussed, Districts are advised to consult the appropriate District and Headquarters representatives for advice and consent. For a list of HOV persons and contacts, please visit the following Intranet address at <http://onramp/hq/trafops/otrafopr/hov/hov.html>. This website is a valuable resource, updated regularly for the most current HOV Program guidance, inventory, reports, and related links.



Thirty years have passed since the opening of the bypass lanes at the San Francisco-Oakland Bay Bridge toll plaza. But it wasn't until the mid-1980's that operational and research data on HOV facilities started to accumulate. This means that guideline updates and revisions will be necessary, as new data becomes available. Through the years much has been learned on the subject although it is recommended that the Districts continue to conduct "before and after" operational studies for HOV projects implemented. Districts are encouraged to support continuous monitoring of the performance of their specific HOV facilities. It is the performance and evaluation of existing operational strategies; plans and services that provide the basis for making revisions to this guide and improved operations of the statewide HOV program. Headquarters' Division of Traffic Operations will, simultaneously, be conducting studies to resolve HOV issues, which are generic in nature and applicable statewide. The results from District and Headquarters' studies, with participation from outside agencies such as the Federal Highway Administration (FHWA), the California Highway Patrol (CHP) and the California Air Resources Board (CARB), will also continue to be used to update these HOV guidelines. A coordinated and cooperative effort is, therefore, needed to ensure these guidelines reflect the latest experience and operational data for planning, designing and operating HOV facilities.

Further discussion on HOV facilities may be found in other publications such as AASHTO's Guide for High-Occupancy Vehicle (HOV) Facilities, June 2003 and Texas Transportation Institute NCHRP Report 414: HOV Systems Manual. Should the District use recommendations from other publications, which either deviate from or are not contained in this document, it is recommended that the District consult with the appropriate Headquarters and District functional units for concurrence.

*Refer to the Division of Traffic Operation's "Ramp Meter Design Guidelines" for guidance on HOV bypass lanes on ramps. For the latest information regarding the Ramp Metering Program, please visit the intranet website address at http://onramp/hq/trafops/otrafopr/frwy_ops/frwy_ops.htm.

**Congestion****Air Quality****Funding & ROW****Development**

Section 1.1 General

California's High-Occupancy Vehicle (HOV) lanes were initially considered as an innovative traffic management strategy, adding capacity during the reconstruction of the San Francisco-Oakland Bay Bridge in 1962 when an exclusive lane was provided for buses. The majority of California's HOV facilities were planned and built on a "route" or "corridor" basis. In some cases, HOV facilities were designed as "queue-jumpers" to give multiple-occupant vehicles a time advantage over single-occupant vehicles. This was understandable and appropriate, at the time, considering HOV experience (both state and nationwide) was in a fluid state where operational data was lacking and public acceptance of HOV facilities uncertain. Still, the overall performance of those HOV facilities frequently exceeded expectations and, in some cases, projected HOV demands were met within a year or two of implementation. While a region-wide HOV system is ideal, such a system requires a supporting cast of HOV freeway-to-freeway connectors, direct access ramps to local cross streets, park and ride/transit facilities, and rideshare inducement and promotional programs. The

cost of providing these elements requires a high degree of political and public commitment to the HOV philosophy which, during the early years of HOV application, did not exist. However, as traffic demand continued to exceed the capacity of many of the state's metropolitan freeways, and as existing HOV facilities have proven to be successful, the California Department of Transportation (Department) and its regional partners have responded by jointly drafting HOV system plans for the six major metropolitan areas of the state: Sacramento, San Francisco Bay Area, Los Angeles, San Bernardino, San Diego and Orange County. These system plans will be revised periodically as appropriate.

Planning for HOV facilities is integrated into the District's system planning process through the District System Management Plan (DSMP), Transportation Concept Reports (TCR), and Transportation Development Plan (TDP). It also provides a linkage between system planning and the preparation of Project Study Reports (PSRs). The appropriate level of planning, analysis and system development for HOV planning must be incorporated into these documents.

Procedurally, there is no difference between HOV projects and other capital outlay projects as they advance from the planning phase into the project development process. The PSR is one of the critical documents as a HOV proposal advances from the planning phase into the project development phase. During the development of a PSR, consideration should be given to the type of HOV facility which best balances the traffic demands of the corridor with cost, right of way and environmental concerns. The next two chapters, “HOV Operations” and “HOV Geometric Design,” should also be consulted when preparing the PSR and the project report.

Section 1.2 HOV Statutes and Policies

Numerous statutes and policy memoranda affect the planning and implementation of HOV facilities. Some of these are summarized below. See Appendix A for complete text.

A. Caltrans - Policy and Procedures

Memorandum P89-01:

The Department will consider a HOV lane alternative for all projects which add capacity to metropolitan freeways or proposed new metropolitan freeways.

The Department will work with regional transportation planning agencies in the conceptual planning phase to develop regional HOV lane system plans in metropolitan areas and to include these systems in the regional transportation plans.

B. Caltrans - Delegation of Authority for HOV Occupancy Determination:

Occupancy requirements for HOV facilities, as well as vehicle types allowed, need to be approved by the District Director at least one month prior to the opening of the HOV lane to traffic. It is also encouraged that Districts include the California Highway Patrol concerning occupancy requirements.

C. California Transportation Commission, Resolution G-87-8:

“BE IT RESOLVED, that in the planning of any new freeway facility or freeway capacity addition in and around a metropolitan area, the Department ... shall examine and report to the California Transportation Commission on the feasibility ... of designating bus and carpool lane operation...”

“That such examination should consider the possible extension of bus and carpool lane operation into existing adjacent facilities ... that the Commission shall also give serious consideration to extending such a bus and carpool facility to existing adjacent facilities when it is demonstrated to be feasible and of likely benefit and to contribute to the operation of the bus and carpool facility within the new project.” See Appendix A-6.

D. California Vehicle Code (CVC) 21655.5:

“The Department ... and local authorities ... may authorize or permit exclusive or preferential use of highway lanes for high-occupancy vehicles. Prior to establishing the lanes, competent engineering estimates shall be made of the effect of the lanes on safety, congestion, and highway capacity.” See Appendices A-7 and A-8 for this and other HOV related CVC’s.

The Department has determined that a separate, detachable report is required to consider the safety and capacity aspects of HOV projects. If the project already has an approved project report, this separate report should be reviewed and concurred with by District Legal and, at a minimum, signed by the chief of the unit preparing the report before the PS&E is sent to Headquarters Office Engineers. For projects without an approved project report, this report should be attached to the project report and be part of the project report approval process. The development of the HOV report is encouraged as early as possible prior to PS&E. See Appendix B for the recommended format of the report.

E. California Vehicle Code 21655.6:

“Whenever the Department of Transportation authorizes ... preferential lanes ... the department shall

obtain the approval of the transportation planning agency or county transportation commission prior to establishing the exclusive use of the highway lanes.” See Appendix A-7.

F. Federal Highway Act, Title 23, Chapter 1:

Authority for Department of Transportation to approve HOV facilities on Federal Aid Systems to increase the capacity for the movement of persons.

See Appendix A-11.

**G. FHWA, California Division Office,
Procedure Memorandum D 6103:**

Regional Transportation Planning Agencies should develop in concert with Caltrans and local agencies, route specific region-wide HOV system plans as a part of the regional transportation plan in metropolitan areas.

A HOV lane shall be an essential alternative for evaluation in the project development process when considering an additional lane by re-striping and/or reconstruction or widening on freeways with three or more lanes in one direction. See Appendix A-12.

**H. Public Resources Code - Chapter 5.8,
Section 25485:**

“The Department shall develop programs and undertake any necessary construction to establish, for the use of carpool vehicles carrying at least three persons, preferential lanes on major freeways...”

I. Streets and Highways Code - Section 149:

“The department may construct exclusive or preferential lanes for buses ... and other high-occupancy vehicles...”

**J. Surface Transportation Assistance Act -
Section 167:**

Motorcycles are permitted in high-occupancy and other exclusive vehicle lanes constructed with federal

participation unless such use would create a safety hazard.

NOTE: The policies and statutes are intended for urban freeways and that FHWA, CTC, and Department policies do not expect rural freeways to have HOV facilities.

Section 1.3 HOV Planning

The planning of HOV facilities should focus on the people carrying capacity of the system rather than on vehicle capacity. In accordance with the Department’s mission as a multi-modal organization, HOV planning should focus not only on multi-occupant cars and vans but also on buses and other transit vehicles. Therefore, the planning process should consider complimentary support elements such as park and ride lots, bus/transit stations, and ingress/egress to them.

Section 1.3.1 HOV Issues

Several specific planning issues are pertinent to HOV system planning. These issues are discussed below.

A. HOV Factors and Criteria

A HOV proposal must be:

1. Consistent-with district management strategies as identified in the DSMP and the TCR.
2. Consistent with objectives and strategies of the congestion management program.
3. Supportive of regionally adopted Transportation Control Measures (TCMs) and with the approved Air Quality Management Plan (AQMP).
4. Consistent with the short and long-term elements of the Regional Transportation Plan (RTP).

Assuming the above criteria are met, the HOV proposal should be analyzed to respond to the following questions:

1. Will geometric cross-sections conform to the Highway Design Manual? If not, will the design exception be approved?

2. Will the project result in a deterioration of highway safety?
3. Will traffic forecasts for one year from opening indicate that a minimum of 800 vehicles per hour per lane (vphpl) or 1800 persons per hour per lane (pphpl) will be using the HOV facility during the peak hour? FHWA, California Division Office, Procedure Memorandum D 6103, see Appendix A-12, stipulates that an additional lane could be a mixed-flow lane if five years after opening, the HOV option would be carrying fewer person-trips. However, experiences in California indicate that adverse public reaction from perceived underutilization of the HOV facility is a significant factor and that a one-year period may be an appropriate goal.
4. Will the HOV project be cost effective? Factors in benefit/cost analysis should include delay savings (in vehicle-minutes and person-minutes), safety benefits and construction, right of way, maintenance and operation costs. Estimates for delay should consider those incurred by the mixed-flow traffic due to HOV operations.
5. Will the project provide at least one minute of timesavings per mile for an average commute trip? A total savings of five to ten minutes is desirable.
6. Can HOV violations be enforced easily and safely? See Chapter 6, HOV Enforcement.
7. Are HOV support facilities such as park and ride lots, transit facilities and public awareness campaigns available to support the HOV proposal? Such support facilities should be considered for all HOV proposals and, if appropriate, be included in the HOV project.

B. Multiple HOV Lanes

The planning for HOV facilities should consider the eventuality when the capacity of the HOV lane is reached. To maintain the necessary incentive to use the facility, the level of service (LOS) for the HOV lane should ideally be maintained at LOS-C. The HOV facility should not be allowed to reach unstable flow (LOS-E) and certainly should not experience congestion on a regular basis. Therefore, it is essential

that the planning process include options to accommodate additional future HOV traffic. These options include increasing the required occupancy or providing additional HOV lanes. An additional HOV lane to provide passing opportunities may be appropriate when the facility is in mountainous or rolling terrain, particularly if high bus volumes are anticipated.

C. Modeling

Transportation modeling based on analytical tools is being developed through traffic microsimulation and macrosimulation models to evaluate the effectiveness of HOV facilities. Microsimulation is the dynamic and stochastic modeling of individual vehicle movements within a system of transportation facilities. Examples of microsimulation software are: Aimsun, CORSIM, Paramics, Simtraffic, Transmodeller, VISSIM, and WATSIM.

FREQ, PASSER, and TRANSYT7F are examples of simulation software that are macroscopic. These tools are also designed to simulate traffic operations but they do it at the macroscopic level. They are deterministic models that model the movement of groups of vehicles or the average behavior of all vehicles on a given section of facility for a given time period.

In California, the Sacramento Area Council of Governments (SACOG), the Southern California Association of Governments (SCAG), the Metropolitan Transportation Commission (MTC), and the Orange County Transportation Commission (OCTC) are continuing the development of models to forecast travel demand. Each of these are looking at mode split, with emphasis on how many of the potential trips would be carpools, transit, recreational or other special attraction trips.

D. Funding and Prioritization of HOV Facilities

Most funding of HOV projects will be through the Flexible Congestion Relief (FCR) Program. Current efforts are underway to include re-stripped HOV projects, which can be quickly implemented, into the TSM

funding program. To be eligible for the Regional Transportation Improvement Program (RTIP), the project must be included in the county's Congestion Management Programs (CMPs). Together with projects from the Commuter and Urban Rail Program and the FCR Program, the county prepares a prioritized list of projects for the RTIP. The Department's Proposed State Transportation Improvement Program (PSTIP) and RTIP are used by the California Transportation Commission (CTC) as the basis for the State Transportation Improvement Program (STIP).

The regions ultimately decide the prioritization of the HOV project within the FCR. However, it is essential that the Districts provide as much input to the regions as necessary to ensure critically needed HOV projects are prioritized accordingly.

E. Evaluation of Existing Facilities

While the operation of a facility normally includes monitoring performance, this feedback loop must be completed to ensure that appropriate models are developed, and the experience of operating mature facilities shapes planning for new facilities.

Section 1.3.2 Caltrans System Planning

System Planning is Caltrans' long-range transportation planning process and is conducted pursuant to Government Code Section 65086(a) and Caltrans policy, see Appendix A-3. The multi-jurisdictional system planning process is multi-modal and considers the entire transportation network, including rail, air, ferries, mass transit, state highways, and local streets and roads. The process produces three interrelated planning documents, which provide guidance, evaluate transportation corridors and develop system improvements. The three planning documents are:

- (1) the District System Management Plan (DSMP),
- (2) the Transportation Concept Report (TCR), and
- (3) the Transportation Development Plan (TDP).

The linkage of system planning with development of the HOV System Plan is through consistency in the implementation of system management objectives and strategies, the identification of corridor deficiencies and establishment of transportation solutions, and the recommendations and prioritization of system improvements.

A. District System Management Plan (DSMP)

The DSMP outlines the District's strategies to maintain, manage and develop the transportation system over the next twenty years and beyond. It is a multi-modal strategy document describing the Department's goals and policies and the District's objectives and strategies. In the DSMP, modal systems and existing and projected conditions are analyzed, transportation issues are identified and strategies to be implemented to overcome the major issues or problems are established. The DSMP addresses how statutes and policies affect HOV facilities, whether current statutes need revision, the factors that preclude or include HOV facilities from a regional perspective, and the appropriate management techniques to be applied in operating HOV lanes. The degree of detail in which specific HOV facilities are discussed within the DSMP is by a reference to the HOV System Plan. The DSMP may identify specific HOV candidate facility locations (as established within the HOV System Plan) by either a listing, or on a District map. Coordination with other Districts will be necessary when routes cross District boundaries.

The HOV System Plan must be consistent with the system management strategies identified in the DSMP.

B. Transportation Concept Report (TCR)

The Transportation Concept Report identifies multi-modal transportation deficiencies and the improvements necessary to achieve the twenty-year planning concept. The concept considers three modal elements: (1) facility type, (2) level of service, and (3) vehicle occupancy. The TCR is prepared for one of three transportation service areas: the route, corridor or area. Each corridor is evaluated as to how it can be expected to perform over the next twenty years considering funding,

environmental and political feasibility. Operating conditions in each route, corridor or area is projected for the twenty-year planning period. Beyond the twenty-year planning horizon the report identifies the ultimate transportation corridor, corridor preservation opportunities and the potential application of new technologies. The development of the route concept is guided by the management strategies and objectives established in DSMP. The TCR considers HOV proposals identified in the HOV system plan in its analysis for specific alternatives for resolving deficiencies. The HOV system plan must be consistent with the planning concepts identified in the TCRs.

C. Transportation Development Plan (TDP)

The Transportation Development Plan identifies system improvements necessary to overcome transportation deficiencies identified in the DSMP, TCR and regional studies. In recommending system improvements in the TDP, considerations must be made regarding corridor development, funding, local, regional and state priorities, and interregional travel and system continuity. The TDP is developed using two alternative funding scenarios to bracket low and high estimated funding projections. The TDP covers the five-year planning period following the seven-year STIP. Together, the seven-year STIP and the five-year TDP cover the first twelve years toward attainment of the twenty year planning concept. The TDP includes improvement alternatives identified in the TCR, which are consistent with the strategies of the DSMP and regional studies. The TDP considers the HOV System Plan in recommending and prioritizing system improvements.

The HOV System Plan identifies HOV facilities for consideration and prioritization in the TDP.

Section 1.3.3 Regional Planning

The link between HOV system planning and regional planning is expressed through several regional plans and programs, including the Regional Transportation Plan (RTP), the Congestion Management Program

(CMP) and the Air Quality Plan (AQP). To be included in the State Transportation Improvement Program (STIP) and receive funding from the Flexible Congestion Relief (FCR) Program, a HOV project must be included in the Capital Improvement Program (CIP) of the CMP and be submitted through the Regional Transportation Improvement Program (RTIP). CMPs are required to be consistent with the RTP, which in turn must conform to federally required AQPs. Any project having federal-aid funds and/or approval requires a National Environmental Policy Act (NEPA) document. The project is required to be fully funded and in the financially constrained RTP/RTIP for FHWA to give NEPA approval.

A. Regional Transportation Plan (RTP)

The RTP is the document that the Regional Transportation Planning Agency (RTPA) uses to describe the existing system, discuss current trends, and express their intentions and needs for the transportation system within the region. It is prepared by the regional Council of Governments (COG), Local Transportation Commission (LTC), or statutorily created RTPA. Updated every two years, the RTP is a twenty-year plan containing maps, policies, and short-term (five to ten year) and long-term projects for each mode of transportation. For metropolitan areas, HOV facilities should be consistent for both the short and long-term elements of the RTP. Short-term projects should consider the easily implemented re-striped HOV lanes, which are normally retrofitted within the existing right of way. Long-term HOV applications should include considerations for facilities involving structures and multiple HOV lanes.

B. Congestion Management Program (CMP)

Urbanized counties over 50,000 in population are required to develop CMPs. Two of the five elements of the CMP have linkage to the HOV program. These are: (1) the Transportation Demand Management (TDM) and trip reduction element, and (2) the Capital Improvement Program (CIP). The TDM element involves HOV facilities in that its purpose includes improving system efficiency by increasing person throughput and reducing vehicle demand. In addition, the HOV project must be

included in the Capital Improvement Program of the Congestion Management Program before it can be considered for the RTIP.

HOV projects may also be included as a part of a deficiency plan that is developed by the local governments to ensure conformance with the CMP. Deficiency plans are developed to either mitigate a specific instance of nonconformance or, if the instance cannot be mitigated, to measurably improve the overall performance of the system and contribute to significant improvements in air quality.

C. Air Quality Plans (AQP)

The California Clean Air Act requires that AQPs be prepared for non-attainment areas of the state that have not met state air quality standards for ozone, carbon monoxide, nitrogen oxide and sulfur dioxide. These plans must include a wide range of control measures, which, for most areas, include Transportation Control Measures (TCMs). HOV systems plans support and conform to these TCMs, which include the following:

1. Regulatory Measures
 - a. Employer based trip reduction rules
 - b. Trip reduction rules for other sources that attract vehicle trips
 - c. Management of parking supply and pricing
2. Transportation System Improvements
 - a. HOV system plans and implementation programs
 - b. Comprehensive transit improvement programs for bus and rail
 - c. Land development policies for motor vehicle trip reduction
 - d. Development policies to strengthen on-site transit access for new and existing land developments

Since regional transportation plans and congestion management programs must conform to the Federally required AQPs, which are focused on trip reductions, it is expected that HOV facilities could be a preferred alternative for most capacity-adding freeway projects in

urban areas. Since the CTC-adopted guidelines for Flexible Congestion Relief (FCR), which include funding eligibility for rail systems, it may be that HOV projects will not compete well for funding priority in the RTIP. Therefore, the possibility exists that HOV projects will not be fundable in a timely fashion within the Flexible Congestion Relief (FCR) Program. Re-striped HOV projects can be implemented within a year and require no right of way. In the future such projects may be eligible for the Traffic System Management (TSM) program. However, current eligibility guidelines for the TSM program do not include re-striped mainline HOV facilities since such projects create a through lane.

In November 1990, Congress adopted the Federal Clean Air Act Amendments (CAAA) of 1990. The CAAA requires states that are not meeting federal standards for Carbon Monoxide (CO) and ozone to develop State Implementation Plans (SIPs). SIPs are required to be able to reduce emissions to federal standards and are closely linked to vehicle miles of travel (VMT). All RTPs must conform to the SIP. The Federal Government may impose sanctions for failure to comply with CAAA SIP requirements. These sanctions include withholding of approval of federal highway projects. However, HOV lanes may be exempt from such sanctions.



Section 2.1 General

The operation of a High-Occupancy Vehicle (HOV) facility is closely linked to its design features and the traffic demands on the freeway corridor. Therefore, operational characteristics must be considered not only during the design process, but also for HOV system planning. As recommended for design features, operational characteristics should also be uniform and consistent within a region.

In areas where the central business district is less identifiable and consists of pockets of intensive business activity distributed over a wide area, sometimes called a “suburban” geographical area, the commute pattern is less definitive and the directional traffic split is more equal than that of the “radial” geographical area. For the suburban geographical area, a two-way flow is preferable and reversible HOV operation would not be appropriate.

When a metropolitan area largely consists of a central business district with weekday commuter traffic from outlying areas, often referred to as a “radial”

geographical area, the traffic demands on each corridor normally would indicate definite directional peaks during the morning and afternoon commute periods. If traffic in the off-peak direction is light (35% or less of the total freeway traffic during the peak periods) and is forecast to remain light during the design life of the project, then a reversible HOV operation may be appropriate. Since barrier-separated facilities offer features suitable for a reversible operation, it would be one of the logical candidates for initial consideration.

As discussed in Chapter 3, “HOV Geometric Design” facilities can be barrier-separated, buffer-separated or contiguous. The different modes of operation and their applicability with each type of geometric configuration will be addressed below.

Section 2.2 Modes of Operation

HOV facilities can be operated with two-way flow, reversible flow, or contraflow.

Section 2.2.1 Two-Way Flow

Two-way flow HOV operation is appropriate when the existing peak period directional traffic is 35/65 or more evenly split and is expected to remain so during the design life of the project. It is the predominant mode of operation for the Department's HOV facilities.

When right of way and cost constraints allow, a two-way barrier-separated HOV facility, with a physical barrier separating the HOV lanes from the mixed-flow lanes generally offers a higher level of service than other geometric configurations (See Chapter 3). A portion of the El Monte Busway (LA-10) near Los Angeles is one example of this type of facility.

Operating data indicates that busways experience congestion at about 1,500 vehicles per hour. Therefore, consideration has been given to using a three plus (3+) occupancy requirement or to having more than one HOV lane in each direction when traffic exceeds this number. Because of potential visibility problems between buses and motorcycles, exclusion of motorcycles on HOV facilities with high bus volumes may be appropriate. However, such exclusions are only allowed if a documented study for that specific HOV facility indicates that motorcycle use constitutes a safety hazard and the exclusion is approved by the Federal Highway Administration.

Section 2.2.2 Reversible Flow

Reversible flow is an operational mode where the HOV lanes operate in one direction during the AM peak period and change to the opposite direction during the PM peak period. This type of operation is feasible only if the existing and forecast peak period directional traffic split is 35% or less in one direction during the design life of the project. Other factors, which could support the use of a reversible flow operation, are right of way constraints and physical constraints, such as bridge columns, in retrofitting a reversible flow operation into the median.

Reversible flow operation should only be used on barrier-separated HOV facilities with limited ingress/

egress to the HOV lanes (See Chapter 3). Its operation can be expensive in terms of equipment and manpower. Also, a reversible facility is functional only during peak periods due to required preparations for each directional change.

Section 2.2.3 Contraflow

A contraflow HOV facility uses the excess freeway capacity in the off-peak direction to relieve congestion in the direction of peak flow. With median crossovers, traffic is guided across the median to the inside lane in the opposite direction. Typically, removable pylons, movable barriers or an additional lane is used to separate the contraflow lane from the adjacent mixed-flow lanes. It should only be considered: (1) if the peak period directional traffic split is 35% or less during the design life of the project, and (2) if the speed of the opposing mixed-flow traffic is not reduced by implementation of the contraflow lane.

Between 1974 and 1986, Caltrans operated a bus-only contraflow facility on 4 miles of Route 101 in Marin County, north of San Francisco. The facility, which allowed buses with permits to bypass congestion and go directly into a contiguous HOV lane, used two lanes from the southbound (off-peak) direction with one of the lanes acting as a buffer. The contraflow lane was discontinued after freeway improvements reduced congestion and speeds in the mixed-flow lanes increased to match that of the contraflow lane.

It is unlikely that the contraflow operational mode will be used extensively in California. In most of the State's metropolitan areas, taking an additional lane for a buffer creates an unacceptable level of service for the opposing traffic. Movable barriers or pylons eliminate the need for a buffer lane but their use requires a set-up and take-down process which is costly and which causes potential conflicts between motorists and the placement crew.

Section 2.3 Queue Bypasses

HOV queue bypasses are relatively short sections of HOV lanes, which bypass congestion and provide

significant timesavings for carpools, vanpools and buses. Examples of queue bypasses in California are bridge toll plaza bypass lanes and ramp meter bypass lanes. They are not associated with any particular geometric configuration and need to be designed for specific sites. For ramp meter bypass lanes, refer to the Department's "Ramp Meter Design Guidelines" prepared by Headquarters Division of Traffic Operations.

Section 2.4 Hours of Operation

The determination of whether HOV lanes should be operated part or full-time, from a traffic-operational viewpoint, should be largely a matter of congestion and the length of peak period and off-peak periods. The decision whether to operate on a part-time or on a full-time basis hinges on other factors as well. The factors include traffic safety, political and public considerations, air quality concerns, enforcement issues, and geographical dispersions of trip patterns (radial routes to or from a central business district or a suburban grid pattern with multiple business districts). Most of all, the need to maintain consistent and uniform HOV operation on a corridor by corridor basis is required as well as an ultimate region-wide basis to avoid motorist confusion.

Section 2.4.1 Peak Period Operation

Peak period operation has the following benefits:

- A. Avoid the public perception that the HOV lane is underutilized (the "empty lane syndrome") during off-peak periods, particularly if public sentiment is not totally receptive to the HOV project.
- B. Freeway lane densities are lower during off-peak periods, thus providing a higher LOS.
- C. Lane closures during the off-peak for maintenance creates less congestion due to the availability of the additional lane.

Northern California commute patterns generally consist of two short definable peak commute periods (two to four hours during the mornings and evenings) separated by a long mid-day off-peak period. Traffic-flow characteristics in Northern California are conducive to part-time operation during peak hours with unrestricted access. All part-time HOV facilities in the state are contiguous, which means that the HOV lane is separated from the adjacent mixed-flow lanes by the same broken white line or reflective marker pattern used on the majority of mixed-flow lanes. The HOV lane traffic is free to enter and exit the lane throughout the length of the facility. Part-time HOV facilities provide optimum use of all lanes during off-peak periods, particularly for construction and maintenance purposes.

Section 2.4.2 Continuous HOV Operation

Compared to a peak period operation, continuous HOV operation presents the following benefits:

- A. Signing and delineation are simpler.
- B. Violation rates tend to be lower and enforcement is easier.
- C. There is less motorist confusion concerning operational hours.
- D. Since continuous HOV operation occurs frequently on buffered or barrier-separated facilities, freeway incidents are less likely to affect HOV lane operation.
- E. Since the ridesharing concept is encouraged at all times of the day, there could be a greater mode shift to ridesharing.
- F. Continuous HOV operations can be applied on all types of geometric configurations.

The Southern California commute and peak hours, both in the morning and the evening, (typically between six to

eleven hours) are much longer and separated by a short off-peak period. All, with one exception, full-time HOV facilities in the state are buffered, which means that the HOV lane is separated from the adjacent mixed-flow lanes by a combination of reflective markers and solid yellow and white painted stripes per the California Vehicle Code. These facilities offer restricted access entrances and exits which are clearly delineated with a broken white line. Only one full-time HOV facility, the El Monte Busway on Interstate 10 in Los Angeles County, is barrier separated.

Section 2.5 Vehicle Occupancy

The occupancy requirements for HOV facilities should be based on the following considerations:

- A. Maximizing the person-per-hour throughput.
- B. Allowing for HOV growth and increased usage of the HOV facility.
- C. Maintaining a free-flow condition, preferably a LOS-C.
- D. Conforming to the occupancy requirements of the region, particularly connecting HOV routes.
- E. Completion of a region's HOV system or adjacent HOV facilities could redistribute the HOV traffic, thereby making occupancy adjustments unnecessary.
- F. Adjust occupancy requirements to avoid the perception of lane underutilization.

The predominant occupancy requirement for existing HOV facilities is two plus (2+) and it is expected that most new HOV facilities will be 2+ as well. However, as some existing HOV facilities have become congested, the District should initiate studies for solutions to maintain a desirable level of service. For buffered or contiguous HOV facilities, Caltrans

considers LOS-C occurs at approximately 1,650 vehicles per hour, less if there is significant bus volume or if there are physical constraints.

Increasing the occupancy requirement may be the logical solution if adding a second HOV lane is inappropriate. However, going from 2+ to 3+ may reduce vehicular demand by 75% to 85%. Such adjustments may be too severe if only a 10% to 20% reduction in demand is necessary to maintain free-flow conditions. Districts are strongly recommended to involve the FHWA Transportation Engineer and Headquarters HOV Coordinator if a significant change in existing HOV operations is considered. See FHWA Program Guidance at: <http://www.fhwa.dot.gov/legisregs/directives/policy/hovmemgd.htm>.

Varying occupancy requirements, such as the El Monte Busway on Interstate 10 in Los Angeles County, by time of day is a useful option and could be used in conjunction with computer traffic surveillance and technology currently being implemented by the urban Districts. To avoid public confusion over varying occupancy requirements, it is essential that signs and other motorist information devices clearly relate the necessary message. Changing occupancy requirements, whether permanently or by time of day, is enforcement sensitive and should be coordinated with the California Highway Patrol.

Once a decision has been made to change the occupancy requirement, an intense public information and education effort should precede actual implementation. An adequate period should be allowed for public comment and response.

Section 2.6 Vehicle Types

The Federal Surface Transportation Assistance Act of 1982, in part, permits motorcycles in HOV facilities unless their presence creates a safety hazard. If a documented engineering analysis indicates that motorcycles present more of a safety problem in the HOV facility than in the mixed-flow lanes, then consideration should be given to restricting motorcycles from the HOV facility. Prohibition of motorcycles

requires approval by the U.S. Secretary of Transportation through the Federal Highway Administration, see Appendix A-11. The Districts are advised to consult with Headquarters Traffic Operations when such prohibitions are being considered. Exclusions and changes concerning vehicle types in HOV facilities must be approved by the Director per a December 4, 1989 internal memorandum signed by Director, Robert K. Best.

Section 2.7 Deadheading

The term “deadheading” refers to the use of a HOV facility by transit vehicles occupied only by the driver. Per state legislation, mass transit vehicles were allowed to deadhead effective January 1, 1998 and clearly marked paratransit vehicles were allowed effective January 1, 2003, see Appendix A-7.

Section 2.8 Incident Handling/Special Events on HOV Lanes

Section 2.8.1 Incident Handling

Since the HOV facility is designed to operate at a higher level of service (LOS) than adjacent mixed-flow lanes during commute periods, it is important to isolate the performance patterns of the system. As traffic operations systems (TOS) elements are developed or upgraded in the metropolitan areas, it is essential that such systems provide discrete HOV performance data, e.g. speeds, volumes and lane occupancies so that adjustments can be made to maintain the desirable LOS.

The TOS design should include incident detection verification and handling capabilities for the HOV facility. Frequently, incidents in the HOV lane will result in HOV traffic merging into the adjacent mixed-flow lane. In most cases, the mixed-flow lane should not be closed to mixed-flow traffic and designated a temporary HOV lane. For major incidents in the mixed-flow lanes, Caltrans and the CHP should jointly decide whether to open the HOV facility to mixed-flow traffic.

Freeway Service Patrol (FSP) considerations for HOV facilities should also be an integral element of incident management. This need is particularly acute for barrier-separated HOV facilities, and service patrol activities for the mixed-flow traffic, which do not extend into the HOV facility.

Barrier-separated facilities present different operational problems and possibilities from other types of HOV facilities for handling incidents both in the HOV lane and in the mixed-flow lanes. Incidents in the HOV lane frequently close the lane and require the re-routing of HOV traffic into the mixed-flow lanes. A major incident in the mixed-flow lanes, with multiple lane blockage, may result in utilization of the HOV lane by non-eligible vehicles. Such use of a barrier-separated HOV facility by mixed-flow traffic, particularly for a reversible HOV operation, should be approached with caution. Barrier-separated HOV facilities have very restrictive access points and generally should not be used for incident management unless the incident is of extended duration and where traffic diversion is not possible. If such facilities are to be used, the decision should be made jointly by CHP and Caltrans, who must ensure that all disabled vehicles are removed prior to resuming HOV operation.

Section 2.8.2 Special Events

Special events and weekend traffic normally consist of vehicles with higher occupancy levels than recurrent weekday traffic. Therefore, there should be no need to allow mixed-flow traffic to use a 24-hour HOV facility. For those HOV facilities operating on a part-time basis, consideration should be given to operating the facility as HOV during special events. This would require careful joint planning with the CHP, including the routing of traffic and the use of temporary signing.

Section 2.8.3 Agency Responsibilities

CHP and Caltrans responsibilities regarding incident handling and special events shall adhere to all of the policies contained in the joint operational policy statements.

Section 2.9 Using HOV Lanes For Traffic Management Plans

Traffic Management Plans (TMPs) are required for all highway activities and in particular for major rehabilitation projects where significant delays are anticipated due to construction. One of the possible TMP elements is the use of an interim HOV lane during reconstruction. The interim lane can be achieved by re-striping or by reconstructing the existing median or shoulder.

There have been several projects nationwide which have included the use of interim HOV lanes as a TMP element including the following:

- A. I-376 in Pittsburgh (Parkway East) - Interim HOV lanes for on-ramps resulted in a 21% increase in the passenger occupancy rate with a 66% reduction in the number of vehicles using the corridor.
- B. I-394 in Minneapolis (US 12) - The installation of the interim HOV lane (“Sane Lane”) coupled with free carpool parking in downtown Minneapolis led to a 35% increase in peak hour person-trips.
- C. I-395 in the Washington D.C. Metropolitan area (The Shirley Highway) - During the morning peak periods the HOV lane saved 12 to 18 minutes of commute time when compared to mixed-flow lanes. Within two months, the bus ridership increased by 20%.

Section 2.10 Passing Lanes

Operational experience in California indicates that vehicular speeds in HOV lanes vary to the extent that passing lanes may be justified. Although trucks are normally excluded from the facility, variations in vehicular speed are such that tailgating occurs with regularity. For those situations, passing lanes should be considered where right of way is not a constraint. Such lanes are particularly appropriate for lengthy buffered or barrier facilities in hilly or mountainous terrain with high bus volumes.

Section 2.11 Transit Stations

A viable strategy to increase person trips on a HOV facility is to provide express bus service. When planning this service it is often necessary to provide intermediate passenger access when a high level of transit service is desired. Two types of facilities show the most promise in providing access. They are On-Line Transit Stations and Off-Line Transit Stations.

Section 2.11.1 On-Line Transit Stations

On-Line transit stations are bus transfer facilities located contiguous to the HOV facility. They may serve walk-in passengers from nearby residences or park and ride lots, feeder transit lines or nearby activity centers. Transfers between other express buses operating on the HOV facility can also be accommodated. Stations can be designed to serve either two-way or reversible HOV lanes.

On-Line stations may produce right of way savings, eliminate costly ramp construction that is necessary for off-line stations and provide maximum timesavings. Negative aspects include added noise and air pollution to the users, long walking distances, an increase in transfers between vehicles, and expensive handicap access.

Platform loading facilities may be located in the center of the HOV lanes or on the sides. Center platforms usually require less width, provide for easy transfers, and are less expensive to construct. A major drawback occurs because buses are built to load on the right side of the vehicle. This requires that buses crossover in some manner to orientate themselves for loading. It is necessary for both types that bypass lanes be provided through the platform location to allow other HOVs to proceed without delay.

Section 2.11.2 Off-Line Transit Stations

Off-Line transit stations are bus facilities, which are not contiguous to the HOV facility, but are close enough to receive direct bus service. They could be located at

nearby park and ride lots, at large employment centers, or be a major transit center.

A major cost in providing service to an off-line station is the necessity of constructing either direct connector ramps or a drop-ramp facility. There could also be a considerable time penalty involved in serving this type of facility when compared to an on-line station. Many of the problems involving on-line stations such as pedestrian access, platform location, and other amenities can more easily be resolved with off-line stations.

Each corridor will require detailed studies to determine which type of station should be constructed to provide the desired transit service. Early consultation with the Project Development Coordinator and Headquarters Traffic Reviewer is recommended when transit stations are being considered.

2002 High-Occupancy Vehicle (HOV) Lanes in California

* (Data as of December 2002)

Existing:
1,112 lane-miles

Under Construction:
125 lane-miles

Proposed (through year 2030):
1,045 lane-miles

* This data is updated twice per year and available on the following intranet page: <http://onramp/hq/trafops/otrafopr/hov/hov.html>.




Section 3.1 General

High-Occupancy Vehicle (HOV) projects can be developed as part of new freeway construction, freeway reconstruction, restriping existing freeways, or a combination of these. Since the majority of HOV projects in California involve some form of retrofitting within the existing freeway right of way, this chapter will focus on a set of guidelines for the typical geometric configurations and procedures for reducing the geometric cross sections for HOV facilities.

In general, typical geometric design of HOV facilities conforms to the Highway Design Manual (HDM). Reducing the typical geometrics may be pursued only after every effort to conform to the HDM is unsuccessful and must be evaluated on a case-by-case basis, with safety the primary consideration. District designers are strongly encouraged to seek the advice and input from Headquarters' Traffic Liaisons and Headquarters' Design Coordinators as early as possible. This is encouraged particularly when the project proposes not to conform to HDM standards or this guide.

Justification for the use of anything less than typical geometrics must be well documented by a sound engineering analysis. Any deviation from these

recommendations should be discussed with the FHWA Transportation Engineer, Traffic Operations personnel, from the District and Headquarters, Headquarters' Traffic Liaisons and Headquarters' Design Coordinators. See Topic 82, Chapter 80 of the HDM.

HOV facilities separated by barriers or buffers can typically be applied on all types of geometric configurations. Right of way constraints, and other factors, however, sometimes preclude the separated option. Whether separated or contiguous, the operational differences among the various HOV geometric options are minor when they are compared to the differences between any HOV lane and a mixed-flow lane.

The operation of a HOV facility is closely linked to its design features and the traffic demands on the freeway corridor. Typical geometric configurations are shown in the following sections to illustrate situations most often encountered in California. Because existing freeway geometric sections and right of way availability vary from one location to the next, situations will arise for which none of the scenarios will apply. For those situations, the District designer should consult with Traffic Operations personnel, from the District and Headquarters, Headquarters' Traffic Liaisons and Headquarters' Design Coordinators for advice.

Designers are encouraged to review Deputy Directive DD-43, Appendix A-3, for the policy on HOV Systems and relevant responsibilities. Also, review internal Departmental Memorandum, dated December 11, 1995, Appendices A-4 and A-5, regarding the termination of the HOV lane into its own mixed-flow lane.

This chapter is intended to describe various HOV geometric configurations and the associated traffic characteristics experienced with each option. Existing conditions routinely challenge geometric uniformity; however, every effort should be made to provide consistency in geometrics, signs and markings within a contiguous region, particularly for the same route or for connecting routes.

Section 3.2 General Design Criteria

1. Horizontal Stopping Sight Distance

Stopping sight distance (SSD) shall conform to the HDM standards. Where conformance is not feasible due to median barriers, the height of the taillights of a vehicle can be used as one reason to justify approval of a design exception fact sheet to the standard SSD. An engineering analysis and an approved design exception fact sheet shall document use of anything less than the standard SSD detailed in the HDM. Increasing the height of an object may provide taillight SSD in all situations except crest vertical curves. However, an engineering analysis and an approved design exception fact sheet must document its use.

2. Decision Stopping Sight Distance

Decision stopping sight distance should be provided to the nose of all HOV drop ramps, flyovers, and freeway-to-freeway HOV direct connectors. See the HDM, Section 201.7.

3. Vertical Clearance

The required minimum vertical clearance for major structures on freeways and expressways is 5.1m. An engineering analysis and an approved design exception fact sheet must justify any reduction from 5.1m.

Sign structures shall have a vertical minimum clearance of 5.5m. See the HDM, Section 309.2.

4. Drainage

The drainage of narrow median widths on retrofit HOV facilities should be carefully evaluated in superelevated areas or where the pavement slopes toward the median. A water-carrying barrier, a slotted pipe or an approved alternate must be provided in these areas. The HOV lane should be designed to meet the drainage requirements for a 25-year design storm.

5. Structural Section

The structural section of HOV lanes on new facilities should be equal to that of the adjacent mixed-flow lane unless a greater thickness is required due to anticipated high bus usage.

The structural section for retrofit HOV lanes should be structurally adequate for ten years after construction when reconstruction is warranted. The surface material and cross slope should be the same as the existing lanes. However, when the widening is contiguous to Portland cement concrete (PCC) pavement, and a Pavement Management System (PMS) survey and field review indicate that PCC pavement will need rehabilitation in less than ten years, the widening should be done with asphalt concrete (AC). If the existing pavement requires immediate rehabilitation, the work should be included in the HOV facility project.

6. Lane Width

Three and six tenths meter (3.6m) lanes are typical. See the HDM, Section 301.1. Three and three tenths meter (3.3m) lanes may be acceptable if justified by an engineering analysis and an approved design exception fact sheet. However, the outside mixed-flow lane should remain at 3.6m unless truck volume is less than 3%. When adjacent to a wall or barrier, shoulder widths between 1.5m and 2.4m on mainline HOV facilities should be avoided except as spot locations.

7. Shoulder Width/Horizontal Clearance

Shoulder width shall conform to the standards specified in the HDM, Section 309.1 for compliance with horizontal clearance standards to fixed objects. Less than standard shoulder and horizontal clearance widths must be justified by an engineering analysis and an approved design exception fact sheet.

Section 3.3 Geometric Configurations

Geometrics for mainline HOV facility configurations can be divided into these categories:

- A. **Barrier-Separated**
- B. **Buffer-Separated**
- C. **Contiguous**

The following factors should be considered when determining which configuration is appropriate:

1. Existing Geometric Cross-Section

The majority of HOV projects are retrofitted within the existing right of way by re-stripping or reconstruction. However, if right of way is economically and environmentally feasible and the project is not interim in nature, the HOV project should conform to the HDM standards.

2. Operations

Operational characteristics such as part-time versus full-time operation, reversible HOV lanes, contra-flow lanes and continuous or restricted ingress/egress are essential considerations in determining a suitable geometric configuration.

3. Enforcement

HOV-related violations such as occupancy and crossing buffers must be enforced to maintain the integrity of the lanes. The designer should consider providing enforcement opportunities as discussed in Chapter 6, "HOV Enforcement."



Section 3.4 Barrier-Separated HOV Facilities

Barrier-Separated HOV facilities can be used for reversible or two-way operation. Two-way operation is the most desirable when space and cost considerations are not major concerns. Barrier-separated HOV facilities, whether two-way or reversible, offer operational advantages such as:

1. Ease of enforcement (violations can be enforced at the ingress/egress locations).
2. Ease of incident management.
3. Unimpeded HOV operation without interference from the mixed-flow lanes.
4. Lower violation rates.
5. High level of driver comfort.

A. Two-Way Barrier-Separated HOV Facilities

Geometric cross-sections for a two-way barrier separated HOV facility are shown in Figure 3.1 and an elevated HOV facility shown in Figure 3.3. The elevated option can be used when right of way is limited.

Elevated HOV facilities should be 7.8m or wider between barriers. The 7.8m width between barriers provides flexibility for future conversion to two 3.3m lanes with 0.6m shoulders.

B. Reversible Barrier-Separated HOV Facilities

A reversible barrier-separated HOV facility should be considered when the project is severely constrained by right of way and environmental considerations. In addition, it is essential that the traffic directional split (after allowing for traffic growth) be 65% or more in the

heavier direction of flow. Once implemented, conversion of a reversible operation to other modes can be extremely difficult. However, if the appropriate directional splits can be maintained, this option provides capacity in the needed direction with far less right of way than otherwise required by permanent two-way HOV configurations. A typical geometric cross-section for a barrier-separated, reversible HOV facility is shown in Figure 3.1.



Section 3.5 Buffer-Separated HOV Facilities

The Buffer-Separated HOV facility is set apart or separated from the mixed-flow lanes by a buffer of variable widths, generally 1.2m or less. Buffers 3.6m to 4.8m are occasionally used, particularly if used in conjunction with ingress/egress acceleration and deceleration lanes with potential conversion to additional traffic lanes. However, such wide buffers should only be used when there is adequate width to provide 3.0m or wider shoulders left of the HOV lane. Buffer widths between 1.2m to 3.6m should not be used. This will discourage the use of buffers as a refuge area. Compared to contiguous HOV facilities, buffered HOV facilities generally provide the motorists with a better level of service. This includes higher driver comfort, extra margin of safety through providing extra maneuvering room, and a lessening of the impact from incidents on adjoining HOV and mixed-flow lanes. The typical geometric cross-section for buffer-separated HOV facilities is shown in Figure 3.2.



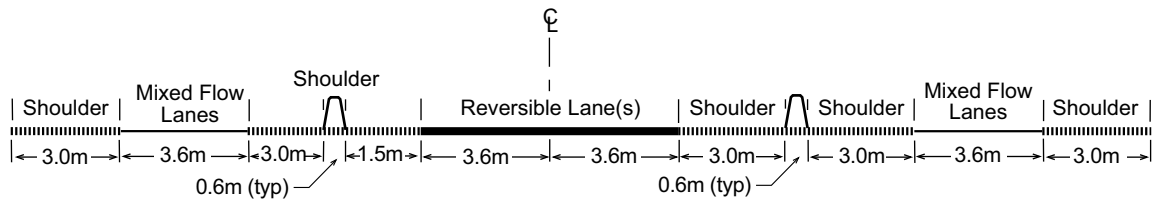
Section 3.6 Contiguous HOV Facilities

Contiguous HOV facilities are normally associated in areas with short duration, high volume peak commute traffic periods. Also, contiguous HOV facilities may be used when right of way limitations preclude buffer separation of the HOV lane from the mixed-flow traffic. Since the HOV traffic is free to enter and exit the lane throughout its length, no design details are required for ingress/egress except at the ends of the HOV facility.

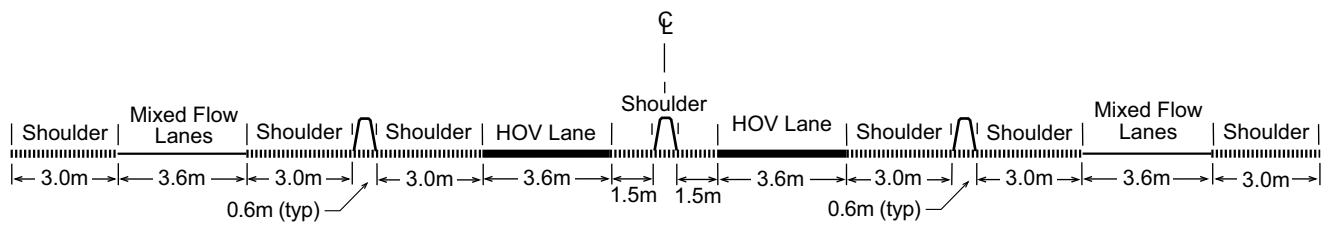
Part-time contiguous HOV facilities allow the use of all lanes during off-peak periods, particularly for construction and maintenance purposes. Additionally, part-time operation may be more acceptable to the motorist not totally convinced of the need for the HOV facility. Because the lane reverts to mixed-flow operation after the peak period, reductions from the typical geometrics need to be carefully analyzed. The typical geometric cross-section for a contiguous HOV facility is shown in Figure 3.2.

**FIGURE 3.1
TYPICAL CROSS SECTIONS
BARRIER-SEPARATED HOV FACILITIES**

NOT TO SCALE



**REVERSIBLE BARRIER-SEPARATED
HOV FACILITY**



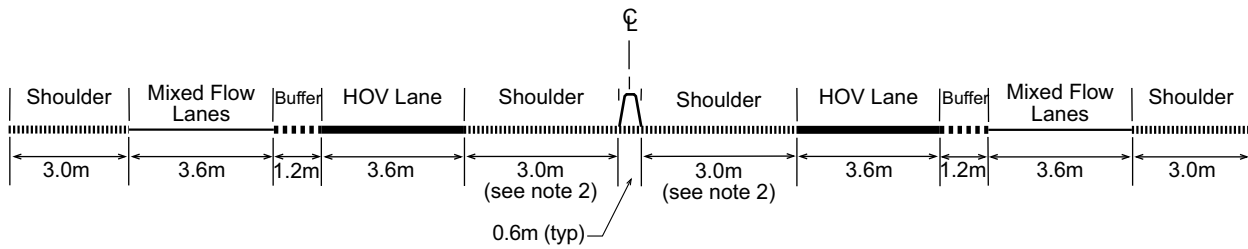
**TWO-WAY BARRIER-SEPARATED
HOV FACILITY**

NOTE: Justification for the use of anything less than typical geometrics must be well documented by a sound engineering analysis. Any deviation from these recommendations should be discussed with the FHWA Transportation Engineer, Traffic Operations personnel, from the District and Headquarters, Headquarters' Traffic Liaisons and Headquarters' Design Coordinators. See Topic 82, Chapter 80 of the HDM.

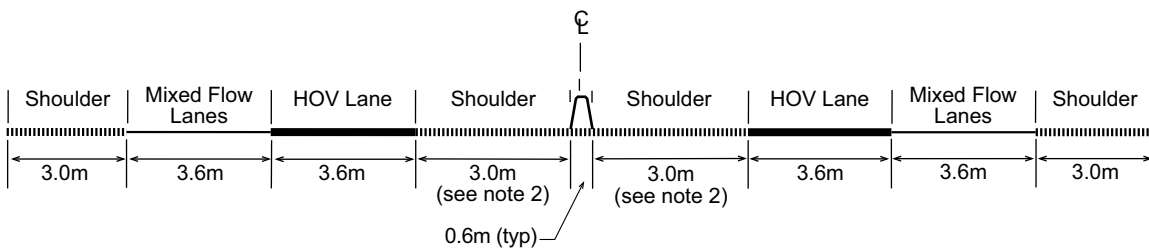


FIGURE 3.2
TYPICAL CROSS SECTIONS
BUFFER-SEPARATED AND CONTIGUOUS
HOV FACILITIES

NOT TO SCALE



BUFFER-SEPARATED
HOV FACILITY



CONTIGUOUS HOV FACILITY

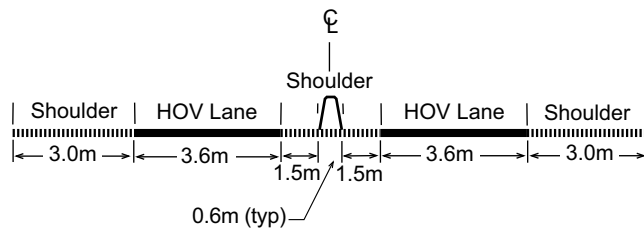
NOTE: 1. Justification for the use of anything less than typical geometrics must be well documented by a sound engineering analysis. Any deviation from these recommendations should be discussed with the FHWA Transportation Engineer, Traffic Operations personnel, from the District and Headquarters, Headquarters' Traffic Liaisons and Headquarters' Design Coordinators.
 See Topic 82, Chapter 80 of the HDM.

2. Requires enforcement areas.
 See Section 6.4, Chapter 6, Enforcement Alternatives.

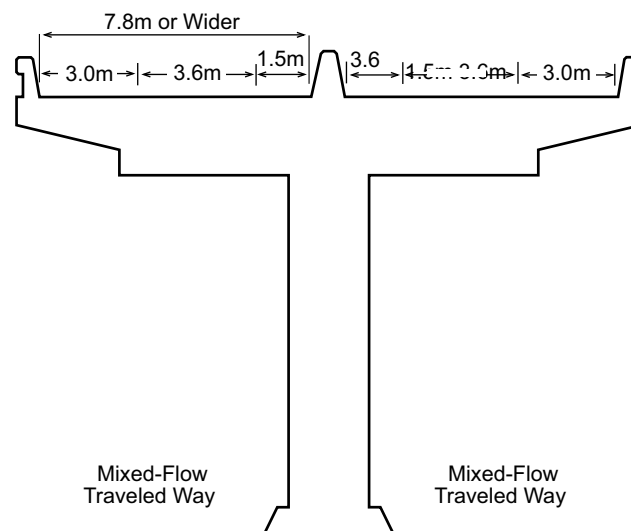


**FIGURE 3.3
TYPICAL CROSS SECTIONS
HOV DIRECT CONNECTOR
AND ELEVATED HOV FACILITIES**

NOT TO SCALE



HOV DIRECT CONNECTOR



ELEVATED HOV FACILITY

NOTE: 1. Justification for the use of anything less than typical geometrics must be well documented by a sound engineering analysis. Any deviation from these recommendations should be discussed with the FHWA Transportation Engineer, Traffic Operations personnel, from the District and Headquarters, Headquarters' Traffic Liaisons and Headquarters' Design Coordinators.
See Topic 82, Chapter 80 of the HDM.

2. All structure design details to be provided by the Engineering Service Center, Division of Structures, corresponding to Caltrans Standard Plans.



Section 3.7 HOV Direct Connectors

Continuing development in HOV design involves HOV direct connectors at intersecting freeways for seamless freeway to freeway movements. As this section is relatively new, operational and support data are becoming available for planning and designing HOV direct connectors. These guidelines will become more definitive as operational experiences accumulate.

The following factors, listed in random order, should be analyzed when HOV direct connectors are being considered. These factors are goals when planning and designing HOV direct connectors.

- A. Will the HOV direct connector provide HOV system continuity and will it be an integral element of the overall HOV system?
 - B. Is forecasted HOV peak hour volume for the connector greater than 500 vehicles per hour per lane (vphpl) or 1100 persons per hour per lane (pphpl) within five years from opening? If not, will space be provided in the interchange to accommodate the eventual construction of HOV direct connectors?
 - C. If the alternative to HOV direct connectors are weaving movements across mixed-flow traffic, will a weaving analysis show the development of a significant bottleneck, resulting in a net loss in overall time savings? If so, this situation may justify building HOV connectors, particularly if bus volume is high.
 - D. Although HOV direct connectors should not be categorically rejected because of cost, will the cost/benefit analysis imply a reasonable rate of return? Anticipated benefits of HOV direct connectors are: (1) net travel-time savings and (2) safety benefits when compared to a ground level merging maneuver. Travel-time savings must consider potential increased delay for the mixed-flow traffic. Timesavings may be based on a “per passenger” basis rather than on the number of vehicles, (i.e. person-minutes rather than vehicle-minutes). Safety benefits for
 - E. Will the community accept the additional structural height, which may be necessary for HOV direct connectors?
 - F. Is there a plan to maintain a desirable level of service for the HOV traffic by: (1) converting to a higher occupancy requirement or (2) providing an additional HOV lane to maintain a desirable level of service for the HOV traffic?
 - G. Will it be fundable? HOV direct connectors are no more expensive than elevated HOV lanes and the need to provide continuity/connectivity may be equally cost effective as additional segments (miles) of HOV lanes, especially when user benefits are included. It is also important for Regional Transportation Planning Agencies (RTPA’s) and Metropolitan Planning Organizations (MPO’s) to recognize their value and plan for these important system components.
 - H. With regard to the buffer-separated or barrier-separated HOV facility, would an additional ingress point be impractical due to the high cost of providing lateral space in the median?
 - I. Will HOV direct connectors promote and enhance HOV usage or transit service in the region or corridor?
 - J. Will HOV direct connectors eliminate or delay the need to reconstruct or add additional capacity or additional connectors to existing freeway-to-freeway interchanges?
 - K. Will HOV direct connectors substantially improve the operational level of service, reducing congestion, on existing or future connectors?
- If a HOV direct connector is feasible after consideration of the above factors, freeway-to-freeway HOV direct

connector geometric standards, except for 1.5m median shoulder should be used. However, when space is limited and the design exception fact sheet is approved, reducing the ramp geometrics may be justified. HOV connectors may merge or diverge from either the right or left side of the through HOV lanes. See the HDM, Section 302.1. Also, no less than 7.8m between barriers should be provided to retain flexibility for initial or future re-striping to two lanes. HOV direct connectors are often long in length, where future expansion to two lanes also serves to accommodate traffic volume growth and/or transit growth. The typical geometric configurations, cross section and schematic plan, for HOV direct connectors are shown in Figure 3.3 and Figure 3.4, respectively.

Section 3.8 HOV Drop Ramps

HOV ramps that provide ingress and egress between HOV lanes and conventional highways, streets, roads, transit facilities or park and ride facilities are sometimes referred to as HOV drop ramps. As is the case with HOV direct connectors, operational and supporting data are becoming available for planning and designing HOV drop ramps. These guidelines will become more definitive as operational experiences accumulate. It is recommended that the following factors be considered when drop ramps are being considered:

- A. Does the benefit/cost analysis regarding timesavings and safety benefits indicate a reasonable rate of return?
- B. Is there a high concentration of HOV demand due to major attractions such as transit facilities, park and ride facilities, central business districts, or industrial concentrations?
- C. Are HOV volumes using the interchange large enough to have a significant negative impact on the through traffic lanes due to weaving maneuvers?
- D. Does removal of HOV traffic improve the operating level of service for the freeway, the interchange, or the cross streets?

It may be difficult, particularly in retrofit situations, to fit HOV drop ramps into the available space. The typical geometric configurations, cross section and schematic plan, to an overcrossing and an undercrossing are shown in Figures 3.5 and 3.6, respectively.

Section 3.9 Local Obstructions

If the geometric configuration for retrofit HOV facilities proves inadequate at localized obstructions, the geometrics may be further reduced provided the necessary design exception fact sheets are approved. For example, FHWA has allowed three tenths meter (0.3m) median shoulders on a case-by-case basis at local obstructions such as signposts. To retain existing overcrossings, they have also agreed to 3.3m mixed-flow and HOV lanes, no buffer, and 0.6m left and right shoulders.

In extreme cases where the cost or impact is great, reducing the right shoulder of ramps or elimination of auxiliary lanes may be considered in order to avoid removal of existing overcrossings. A minimum lateral clearance to the structure or other obstruction should be 0.6m. Benefits of removing the auxiliary lane should be carefully weighed against the adverse operational impacts associated with its removal.

Additional horizontal clearance may be obtained by eliminating the safety shape on the concrete barrier adjacent to structure columns, abutments, or median sign bases as shown in Figure 3.7. The safety shape may be retained at median sign bases by utilizing a steel plate in lieu of concrete.

If the minimum clearance is not achieved by any of the above methods, movement of the columns and replacement or modification of the overcrossing structure should be considered. The length of the new structure should accommodate a full standard facility with the number of lanes indicated in the District's system planning process, included in the Transportation Concept Reports (TCR).

When the approach roadway is widened as part of the HOV project, undercrossing structures should be widened to accommodate the approach roadway.

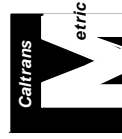
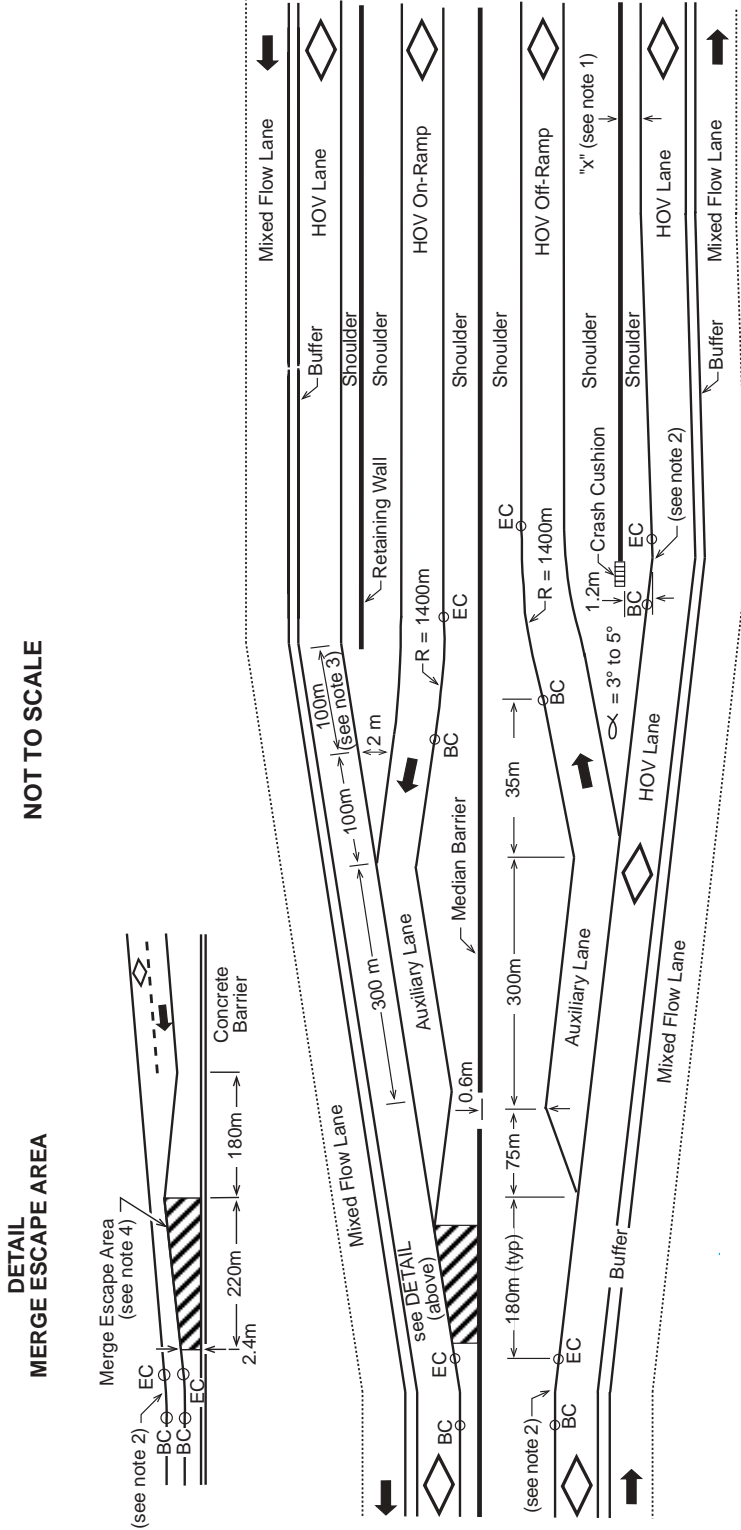


FIGURE 3.4
TYPICAL HOV DIRECT CONNECTOR
ENTRANCES AND EXITS



DETAIL
MERGE ESCAPE AREA

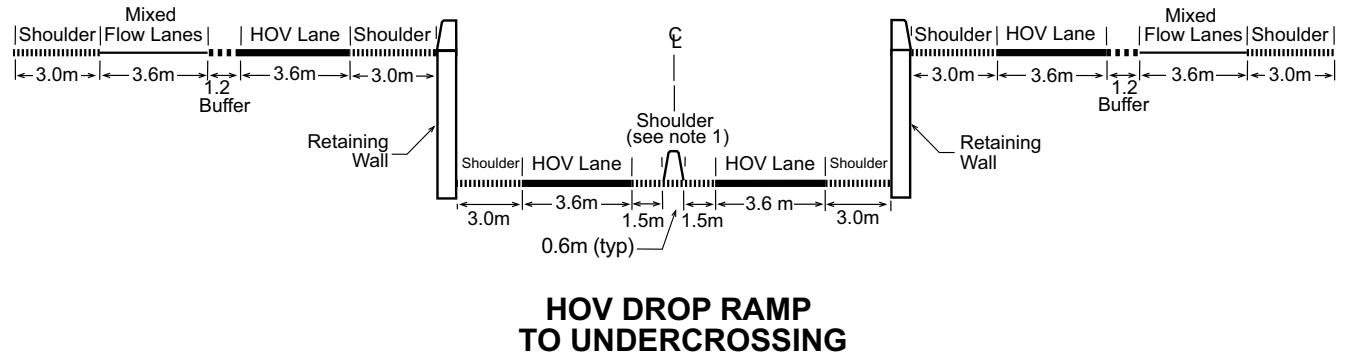
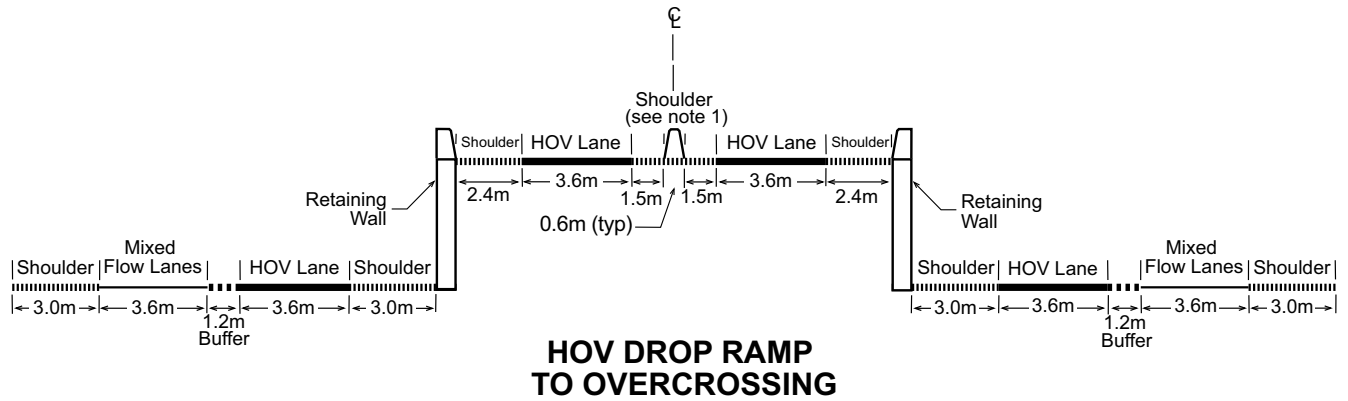
NOT TO SCALE

NOTES:

1. Shoulder widths on HOV Direct Connectors shall conform to the Highway Design Manual.
2. $R = 3000m \cdot \Delta$ is typically less than $01^{\circ}00'00''$. For Δ less than $00^{\circ}30'00''$, a taper may be used in lieu of curve.
3. Entrance profiles should approximately parallel the profile of the freeway for at least 100m prior to the 2m point to provide inter-visibility in merging situations.
4. The Merge Escape Area (Detail) is not required where the left freeway shoulder is 2.4m or greater.

**FIGURE 3.5
TYPICAL CROSS SECTIONS
HOV DROP RAMP TO
OVERCROSSING AND UNDERCROSSING**

NOT TO SCALE



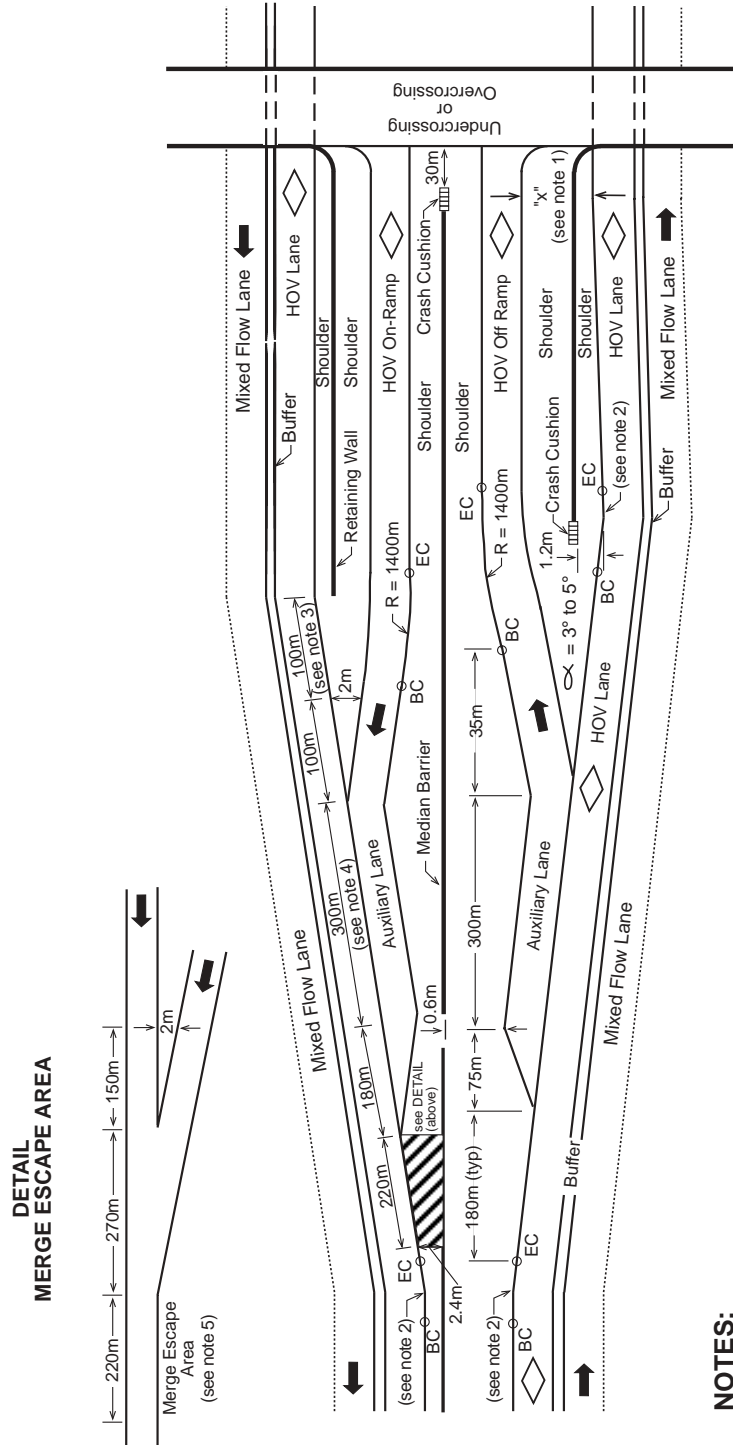
NOTE: Justification for the use of anything less than typical geometrics must be well documented by a sound engineering analysis. Any deviation from these recommendations should be discussed with the FHWA Transportation Engineer, Traffic Operations personnel, from the District and Headquarters, Headquarters' Traffic Liaisons and Headquarters' Design Coordinators.

See Topic 82, Chapter 80 of the HDM.



**FIGURE 3.6
TYPICAL HOV DROP RAMP
ENTRANCES AND EXITS**

NOT TO SCALE



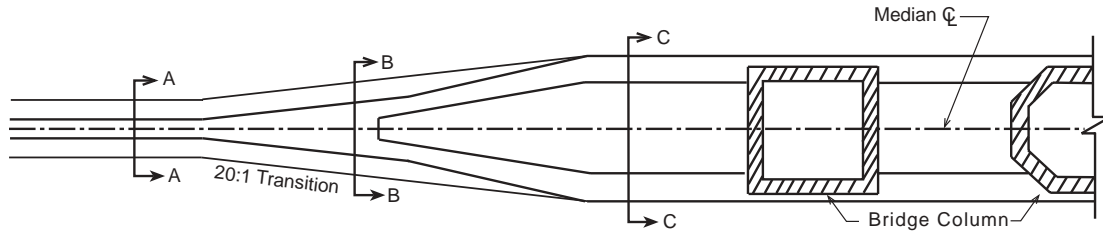
NOTES:

1. Shoulder widths on HOV Drop Ramps shall conform to the Highway Design Manual.
2. $R = 3000m. \Delta$ is typically less than $01^{\circ}00'00''$. For Δ less than $00^{\circ}30'00''$, a taper may be used in lieu of curve.
3. Entrance profiles should approximately parallel the profile of the freeway for at least 100m prior to the 2m point to provide inter-visibility in merging situations.
4. A 300m long auxiliary lane should be provided, particularly on ascending entrance ramps.
5. The Merge Escape Area (Detail) is not required where the left freeway shoulder is 2.4m or greater.
6. The maximum grade on a descending off-ramp should be 6%.

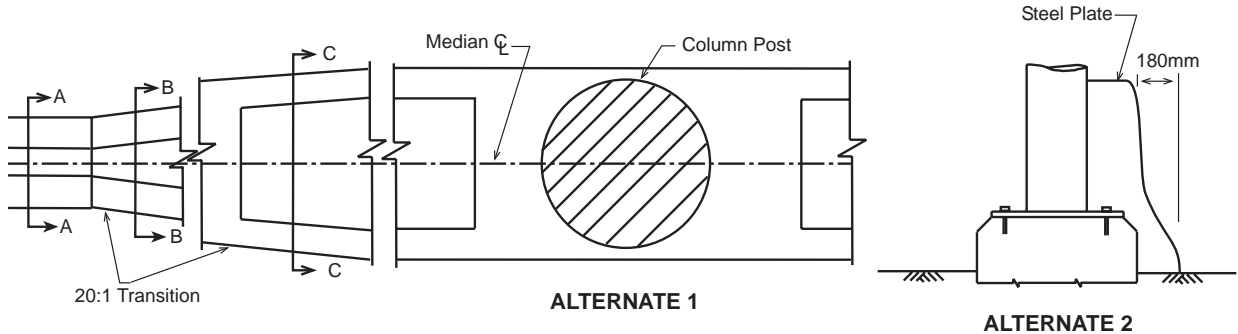


**FIGURE 3.7
MEDIAN BARRIER TRANSITIONS**

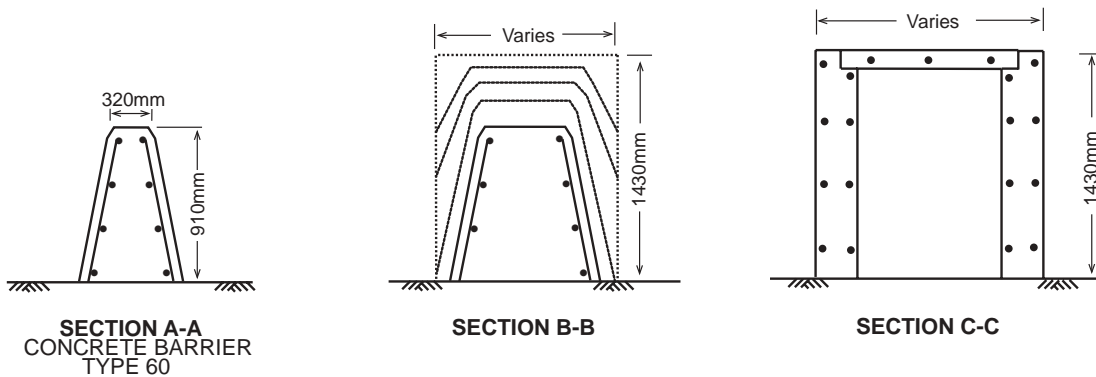
NOT TO SCALE



**MEDIAN BARRIER TRANSITION
AT BRIDGE COLUMNS**



**MEDIAN BARRIER TRANSITION AT
SIGN STRUCTURES AND BRIDGE COLUMNS**



NOTE: All structure design details to be provided by the Engineering Service Center, Division of Structures, corresponding to Caltrans Standard Plans.



Section 3.10 Relative Priority of Cross-Sectional Elements

It may be appropriate to consider minor reductions in lane, buffer and shoulder widths at ‘pinch points’ in order to avoid the complete reconstruction of significant roadway elements (i.e. - overcrossing structures). A reduction in standards for cross-sectional elements may be necessary for most retrofit HOV projects. When necessary, any deviation from the HDM mandatory standards must be discussed with Headquarters’ Design Coordinators and, if justified, will require approved design exception fact sheets. For the mixed-flow lanes, outside shoulder widths and the outside lane widths generally should not be altered. When sufficient justification exists, suggested priority for reduction of the cross-sectional elements for the various geometric configurations is outlined below. Any deviation from mandatory standards shall be discussed with the FHWA Transportation Engineer (at, or impacting, interstate freeways), Traffic Operations personnel, from the District and Headquarters, Headquarters’ Traffic Liaisons and Headquarters’ Design Coordinators. See Chapter 80 of the HDM for specific requirements.

1. Two-Way Barrier-Separated HOV Facilities (See Figure 3.1)

- ◆ First, reduce the left HOV shoulder to 0.6m.
- ◆ Second, reduce the HOV lane to 3.3m.

If the above reductions are not sufficient to meet right of way constraints, then buffer-separated or contiguous HOV facilities should be considered.

2. Reversible Barrier-Separated HOV Facilities (See Figure 3.1)

- ◆ First, reduce the 1.5m HOV shoulder to a minimum of 0.6m while maintaining a minimum 3.0m shoulder on the other side.
- ◆ Second, reduce the HOV lanes to a minimum of 3.3m.

- ◆ Third, reduce the mixed-flow left shoulder to a minimum of 2.4m, if the shoulder is structurally adequate.
- ◆ Fourth, reduce the mixed-flow lanes to 3.3m, starting with the left lane and moving to the right as needed. The outside mixed-flow lane should remain at 3.6m unless truck volumes are less than 3%.
- ◆ Fifth, reduce the left shoulder for the mixed-flow lanes to a minimum of 0.6m. Shoulders less than 2.4m but greater than 1.5m are not recommended. Any excess width resulting from a reduction of median shoulder width from 3.0m to 1.5m or less should be used to restore the mixed-flow lane widths to 3.6m starting from the outside and moving to the left.

3. Buffer-Separated HOV Facilities (See Figure 3.2)

- ◆ First, reduce the median shoulders from 4.2m (the width to accommodate continuous enforcement areas) to 3.0m. Any reduction of the median shoulders should be accompanied by the addition of CHP enforcement areas.
- ◆ Second, reduce the buffer to 0.6m.
- ◆ Third, reduce the median shoulders to a minimum of 2.4m.
- ◆ Fourth, reduce the HOV lane to 3.3m.
- ◆ Fifth, reduce the number one mixed-flow lane to 3.3m.
- ◆ Sixth, reduce the remaining mixed-flow lanes to 3.3m, starting with the number two lane and moving to the right as needed. The outside mixed-flow lane should remain at 3.6m unless truck volume is less than 3%.
- ◆ Seventh, reduce the median shoulders to a minimum of 0.6m. Shoulders less than 2.4m but greater than 1.5m are not recommended. Any excess width resulting from a reduction of median shoulder width from 2.4m to 1.5m or less should be used to restore the mixed-flow lane

widths to 3.6m starting from the outside and moving to the left.

The reduction of the median shoulders from 4.2m to either 2.4m or 0.6m should be combined with the construction of enforcement areas.

4. Contiguous HOV Facilities

(See Figure 3.2)

- ◆ First, reduce the median shoulders from 4.2m (the width to accommodate continuous enforcement areas) to 3.0m. Any reduction of the median shoulders should be accompanied by the addition of CHP enforcement areas.

- ◆ Second, reduce the median shoulders to a minimum of 2.4m.

- ◆ Third, reduce the HOV lane to 3.3m.

- ◆ Fourth, reduce the mixed-flow lanes to 3.3m, starting with the left lane and moving to the right as needed. The outside mixed-flow lane should remain at 3.6m unless truck volumes are less than 3%.

- ◆ Fifth, reduce the median shoulders to a minimum of 0.6m. Shoulders less than 2.4m but greater than 1.5m are not recommended. Any excess width resulting from a reduction of median shoulder width from 2.4m to 1.5m or less should be used to restore the mixed-flow lane widths to 3.6m starting from the outside and moving to the left.

Section 3.11 On-Line Bus Facilities

On-line bus station facilities are built within freeway medians providing buses a direct access to a bus loading and unloading stop without exiting the HOV facility. They are normally located at overcrossings or undercrossings to arterial streets at local bus or rail station connections. Regional Transportation Agencies are normally involved in the planning process if on-line bus facilities are to be considered. A typical geometric configuration, layout and cross-section, for an on-line bus station is shown in Figure 3.8.

1. General

The following amenities should be included in the on-line bus station platform design:

- ◆ Facility Covering: Provide shelter to protect patrons from rain and direct sunshine.

- ◆ Seating: A limited amount of seating should be provided on the platform.

- ◆ Transit Information: A provision in the station design should be made for informational kiosks containing maps and schedules of bus lines.

2. Communications

The following communication requirements should be included in the on-line bus station platform design:

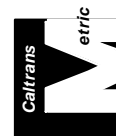
- ◆ Hook-ups to telecommunications and data sources for security and data collection purposes.

- ◆ Pay telephones.

- ◆ A closed circuit television security system.

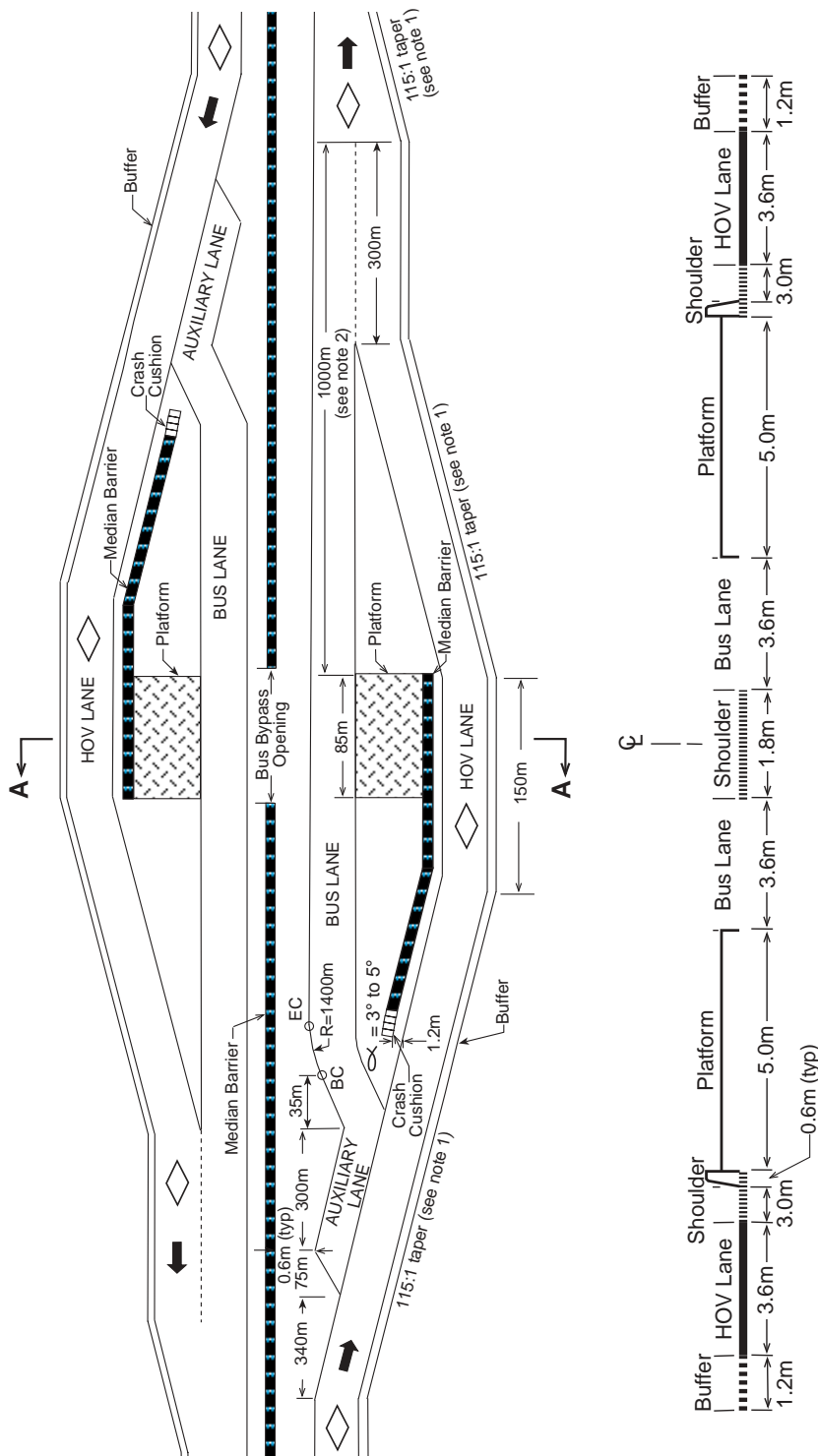
- ◆ A direct line to a dispatcher for emergencies.

- ◆ Direct, on-line transit information.



**FIGURE 3.8
TYPICAL LAYOUT AND CROSS SECTION
HOV ON-LINE BUS FACILITIES**

NOT TO SCALE



SECTION A-A

NOTES:

1. For 115:1 taper, $\Delta = 00^{\circ}30' 00''$. A curve may be used in lieu of a taper. $R = 30000m$. Δ is typically less than $01^{\circ}00' 00''$.
2. 1000m is recommended for bus acceleration.



Section 4.1 Beginning and Termination Points

An entry into the HOV facility should require a conscious movement. A design configuration, which requires mixed-flow traffic to exit, could be susceptible to violations.

A. Start of Facility

Normally an HOV lane should begin on the left of the number one mixed-flow lane as a new lane, at a 90-degree angle (Details M-1 and M-2, Chapter 5) to full width. For a buffer-separated facility, a minimum of 400m of dashed white line should be offered on the right to provide consistency of appearance with ingress and egress areas. See Figure 4.2. The beginning of any buffer should begin no earlier than a distance equivalent to 200m per lane change required entering the HOV lane from the nearest on-ramp. Additional length of dashed white lines may be desired if visibility of the striping is compromised within the 400m distance; for example, at locations where vertical and horizontal curves are present.

B. End of Facility

See Appendices A-4 and A-5: Caltrans, Traffic Operations Memorandum, The Ending of High-Occupancy Vehicle (HOV) Lanes, December 11, 1995.

... concerning the end treatment for HOV lanes, it “has been determined that an HOV lane shall end in a

continuing lane which enables the HOV traffic to continue without a merge. When a lane end has to occur it shall become the standard to drop the outside mixed-flow lane as shown on the attached drawing (Detail M-6, Chapter 5).” If an exception is needed, document the reasons and request an approving signature from the appropriate Headquarters’ Traffic Liaison and Headquarters’ Design Coordinator. “Frequently, the ending of the HOV lane could be shifted up or downstream to make a right merge more feasible.”

“Revisions of plans are required for projects in the planning or design stage.” For those HOV projects under construction with the HOV lane merging, we request review of these projects and request contract change orders as needed.

If the HOV lane has to be merged back into the freeway traffic, a minimum of 400m of dashed white line (920m is desirable) should be provided before the end of the HOV lane taper begins. Additional length may be desired to achieve enhanced or improved visibility of dashed striping at location where horizontal or vertical alignment vary. No less than 200m per lane change should be provided from the end of the buffer to the next off-ramp or connector. See Figure 4.2. Where feasible, greater length may be desired.

In addition, the outside mixed-flow lane may also be dropped at an off-ramp. Engineering analysis is essential with this alternative to ensure congestion does not result near the lane drop location. Typically, there should be a high demand exiting the off-ramp where the lane drop is considered.

Section 4.2 Ingress/Egress For Barrier-Separated Facilities

The at-grade ingress and egress from the mixed-flow lanes to a barrier-separated HOV facility can be achieved with at-grade channelized openings in the physical barriers. A typical geometric configuration is shown in Figure 4.1. The at-grade opening can be accomplished with the use of a weave lane to assist the merging of the HOV traffic with the mixed-flow traffic. The preferable length of the weaving area for ingress and egress designs is 400m, minimum.

Other means of providing access to and from barrier-separated facilities include, but are not limited to:

- A. Median drop ramps from overcrossings or undercrossings.
- B. Freeway-to-freeway connection.

Section 4.3 Ingress/Egress For Buffer-Separated Facilities

Access to and from the HOV lane should be provided by any of the following four general types of ingress and egress designs:

- A. At-grade ingress and egress.
- B. Median drop ramps from overcrossings or undercrossings.
- C. Freeway-to-freeway connection.
- D. Beginning and termination points (as described above).

At-grade access is not intended to serve every on and off-ramp. When it is operationally possible, ingress and egress locations are based on the following criteria:

- 1. To serve every freeway-to-freeway connection.
- 2. To serve high volume ramps.
- 3. Ramps with high number of carpools.
- 4. When adjacent to park and ride facilities.

- 5. When requested by transit districts.
- 6. To assist in the modification of local commute patterns (may be at local request).
- 7. To help balance and optimize interchange operational level of service within a local jurisdiction, within a corridor, or within a region.
- 8. To support and encourage ride sharing programs (HOV demand/usage).

As applied to the buffer-separated facilities, ingress and egress are relative to the origin and destination patterns of HOVs. If the majority of HOVs originate upstream and have destinations downstream of the facility, they will all use the lane facility and there will be little impact related to intermediate access points. However, intermediate access points will allow fuller use of the facility.

The operation of weaving sections needs to be considered. It is important that ingress and egress locations be of proper length and located to provide the best possible access, especially to adjoining freeways. There could be situations in which merging to and from the HOV lane can create queueing in the HOV lane. One example would be providing ingress and egress near ramp locations on a freeway that has many closely spaced ramps in a bottleneck section. This could create conflicts in the flow of both the HOV and mainline facilities. Design should include the consideration of an additional lane between these ramps to allow ingress/ egress to the HOV facility without adversely impacting either it or the mixed-flow lanes. Figure 4.2 indicates recommended weaving distances for buffer-separated facilities.

Provisions for traffic to enter and leave the HOV facility should be provided at every freeway-to-freeway interchange. Ingress and egress to State highways and major arterials should be considered where demand exists and where operation is not severely impacted.

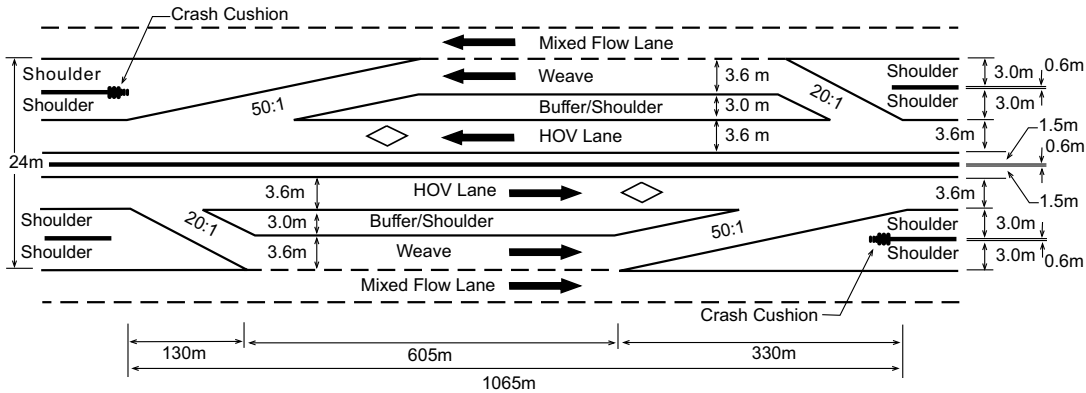
Ingress and egress locations should be on a tangent and away from CHP enforcement areas whenever possible. To ensure ingress and egress locations are placed at optimal locations, District Traffic Operations personnel and the Headquarters' Traffic Liaison should be consulted early in the design phase.

Section 4.4 Ingress and Egress For Contiguous HOV Facilities

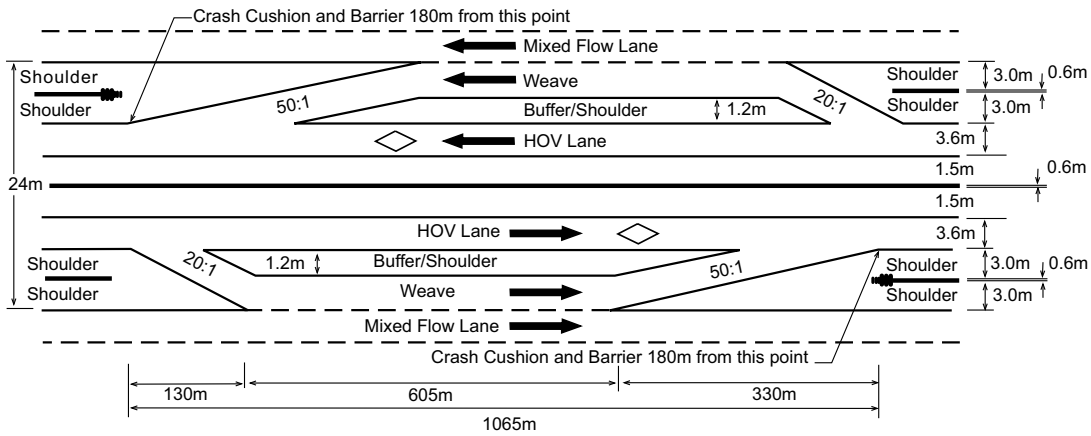
At-grade access for contiguous HOV facilities is unlimited since no buffer or barrier separates the HOV lane from the mixed-flow traffic. See Detail M-3, Chapter 5, as well as the Manual on Uniform Traffic Control Devices (MUTCD) and California Supplement to the MUTCD, which replaces Caltrans' Traffic Manual. When a lane has to be discontinued, it is preferable to drop the outside mixed-flow lane approximately 0.8km after the end of the HOV facility. See Detail M-6, Chapter 5 for more information.

**FIGURE 4.1
INGRESS/EGRESS FOR
BARRIER-SEPARATED HOV FACILITIES**

NOT TO SCALE



FOR 3.0m BUFFER/SHOULDER AREA



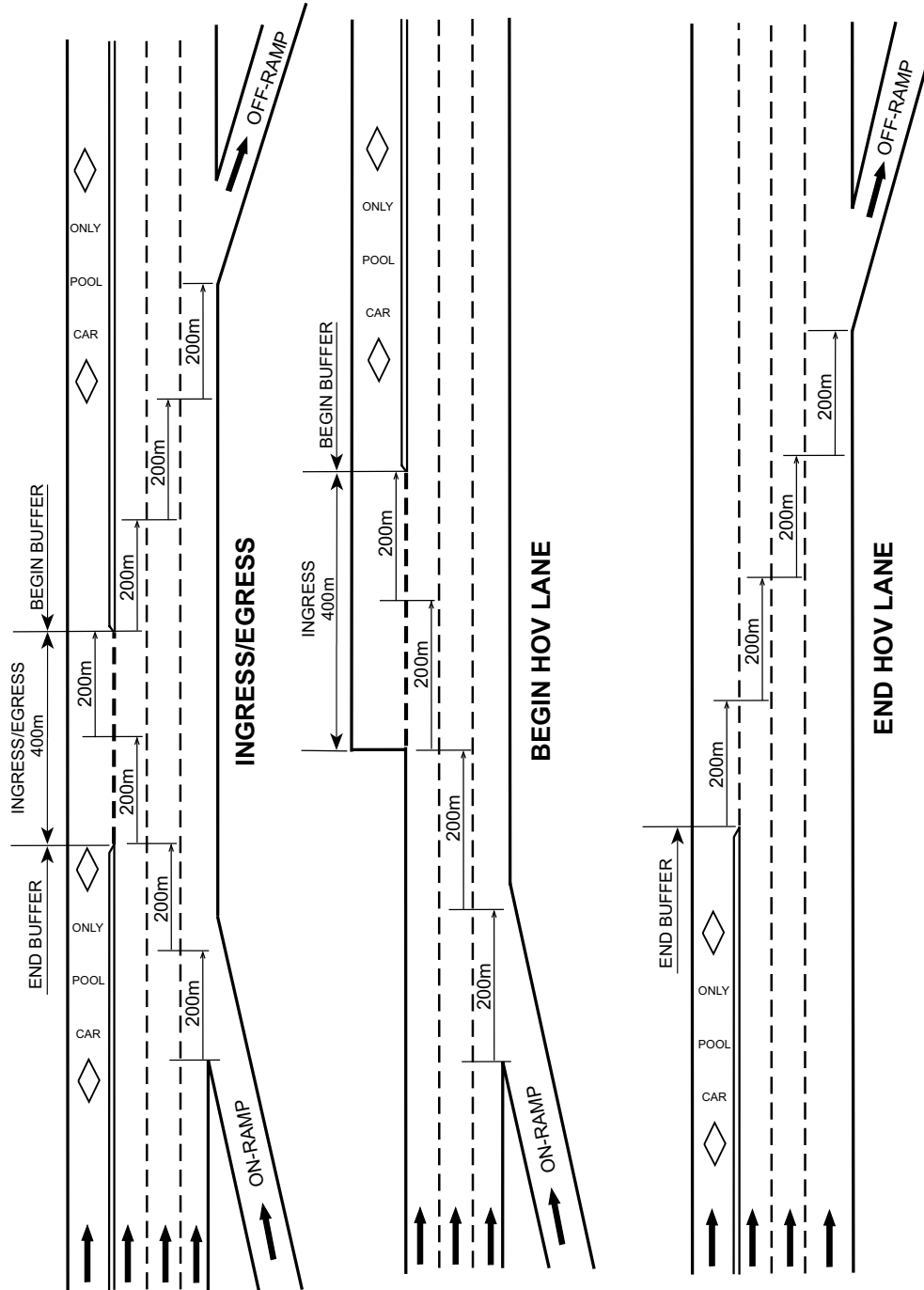
FOR 1.2m BUFFER/SHOULDER AREA

NOTE: When necessary, any deviation from the HDM mandatory standards must be discussed with the Headquarters' Design Coordinator and, if justified, will require approved design exception fact sheets. For the mixed-flow lanes, widths for the outside shoulder and the outside lane generally should not be altered. When sufficient justification exists, suggested priority for reduction of the cross-sectional elements for the various geometric configurations is outlined in Section 3.10. Any deviation from these recommendations should be discussed with the FHWA Transportation Engineer, Traffic Operations personnel, from the District and Headquarters, Traffic Operations Liaison and Design Coordinator.





**FIGURE 4.2
WEAVE DISTANCE AT
BUFFER-SEPARATED HOV FACILITIES
NOT TO SCALE**



NOTE: Any deviation from mandatory standards shall be discussed with the FHWA Transportation Engineer (at, or impacting, interstate freeways), Traffic Operations personnel (from both the District and Headquarters), Headquarters' Traffic Liaisons and Headquarters' Design Coordinators.



Section 5.1 General

These guidelines for mainline HOV signs and markings follow the general principles in the Manual on Uniform Traffic Control Devices (MUTCD) and California Supplement to the MUTCD, which replaces the Caltrans' Traffic Manual. Should a particular situation occur where neither the MUTCD, California Supplement to the MUTCD nor these HOV guidelines are sufficient, the District is advised to consult the Headquarters' Traffic Liaisons or Headquarters Traffic Operations, HOV Systems Branch personnel, for guidance.

The need for specific HOV sign and marking guidelines arises from the fact that most HOV facilities are retrofitted into existing mixed-flow facilities where the two types of facilities have very distinctive operating characteristics. That one system is superimposed onto another often means that space for signs and markings is very restrictive, which varies by different geometric configurations and modes of operation among districts. These include geometric variations for contiguous, buffer-separated or barrier-separated HOV facilities and differences such as varying operational hours and occupancy requirements. Therefore, it is essential that the design and placement of HOV signs and markings clearly indicate whether they are intended for motorists in the HOV or the mixed-flow lanes. They should convey a message that HOV lanes are restricted to HOV's, provide clear directions for ingress/egress areas, define vehicle occupancy requirements, the hours of operation, and violation fines. See the following Chapter 5, HOV Details and Sign Specifications, as well as Chapter 5 Appendices A and B, which include HOV Sign Policy Statements.

Much of HOV signs and markings relate to enhancing safety for the motorists. Geometric standards may be impacted due to the lack of right of way. Also, operational characteristics such as the differential speed between the HOV lane and the adjacent mixed-flow traffic, the lack of passing opportunities in the HOV lane, and the necessity for frequent merging and weaving actions, mean that messages must be clear and succinct wherever possible. Special situations, such as inclement weather and lower visibility conditions during hours of darkness, also need to be considered since heavy HOV lane usage may occur in early morning and late afternoon periods. The signs and markings must not only consider the typical commuter but also the occasional user of the facility who may be unfamiliar with the HOV facility and its operation.

Maintenance and update of the HOV signs and markings after initial implementation are also essential. When operational conditions change for a HOV facility, it is important to revise the signs and markings to reflect that change. For maintenance purposes, the geometric impacts often mean narrow lanes, shoulders and buffers, reduced access for maintenance vehicles and an increased need to maintain stripes and markers, particularly where there is heavy bus usage. Consideration should be given to replacing worn out signs and markings in conformance with updated guidelines.

As used by Caltrans, the diamond symbol is used only to designate HOV facilities. While the symbol is sometimes used elsewhere in the nation for other applications, it is the intent of Caltrans to use this symbol only for HOV purposes. For signs, whether regulatory, guide or

warning in nature, it is typically a white symbol on a black background to convey the restrictive nature of the HOV lane and to make it more readily recognizable. The use of the symbol with all HOV signs also informs drivers, whether they are in the mixed-flow lane or HOV lanes that the messages conveyed are only intended for HOV's.

Where HOV corridors overlap district boundaries, regional consistency in signs and markings must be maintained to minimize motorist confusion. While these guidelines contribute toward a statewide consistency in HOV signs and markings, specific situations may occur where the guidelines may not be applicable. In those situations, the Districts are advised to work with one another to ensure regional consistency in signs and markings. Also, consult with Headquarters Traffic Operations personnel if the matter has policy or statewide implications. It may also be appropriate to consult with outside agencies, such as the California Highway Patrol, as enforcement of HOV violations and signs and markings are related issues.

Section 5.2 HOV Signs

The signs and markings details, Details M-1 to M-11, provide guidance for the most common HOV geometric configurations used by Caltrans, such as the contiguous, buffer-separated and barrier-separated HOV facilities, and direct HOV connectors to and from arterials.

Signs for other types of HOV facilities, such as those used for reversible-flow and contra-flow operations, direct HOV connectors between freeways and temporary HOV lanes used during construction, should be designed using the MUTCD and California Supplement to the MUTCD, and by consultation with the appropriate Headquarters and District Traffic personnel.

In general, signs for direct HOV connectors between freeways will need HOV guide signs, both advance and action, in addition to the normal regulatory signs. Signs for reversible-flow HOV facilities are done on a case-by-case basis. However, it will typically require overhead changeable message signs at both ends of the facility and general HOV regulatory signs (R86-2,

R93-2), mounted back to back, between the entrance and exit. When changeable message signs are used to convey lane use restriction, other signs to convey the same message are not mandatory but may be used as supplemental controls.

Frequently, it is necessary to place ground-mounted signs on top of median barriers. If so, it is essential that no portion of the sign panel project beyond the barrier base, particularly in narrow medians. For example, for a 900-mm wide panel and a barrier base 610 mm wide, the maximum angle between the sign panel and the axis of the barrier is 42 degrees. A 900-mm wide sign panel is the maximum width unless the median barrier has been retrofitted to accommodate a wider sign panel. Wider panel signs may be used where the median is wide enough to place ground mounted signs off the barrier.

Regulatory signs for HOV facilities follow the standard regulatory signing principles; black legend with a white reflective background on a rectangular panel. These include the following:

- R82-1** CARPOOL LANE AHEAD, ½ MILE
- R82B** ___AM - ___AM, ___PM - ___PM,
MON - FRI
- R84-1** END CARPOOL LANE
- R84-2** CARPOOL LANE ENDS, ½ MILE
- R86** LEFT LANE, CARPOOLS ONLY,
___AM - ___AM or ___PM - ___PM,
MON - FRI
- R86-2** LEFT LANE, CARPOOLS ONLY
- R86-3** LEFT LANE, CARPOOLS ONLY,
___AM - ___AM, ___PM - ___PM,
MON - FRI
- R87-1** CARPOOLS ONLY, ___ OR MORE
PERSONS PER VEHICLE
- R87-2** CARPOOLS ONLY, ___ OR MORE
PERSONS PER VEHICLE
(for HOV Drop Ramps)
- R91-2** NO TRUCKS OVER 5 TONS OR
VEHICLES WITH TRAILERS
- R93A** VEHICLES WITH DMV CLEAN AIR
DECAL OK
- R93-2** CARPOOL IS ___ OR MORE PERSONS
PER VEHICLE

SR50-1 CARPOOL VIOLATION \$ ___ MINIMUM FINE (for heightened enforcement)

SR50-2 CARPOOL VIOLATION \$ ___ MINIMUM FINE

Note that the sign layout plans, Details M-1 to M-11, do not include instructions on using the overhead sign SR50-1 (CARPOOL VIOLATION \$ ___ MINIMUM FINE). However, the use of SR50-1 is beneficial where high violation rates are experienced. The SR50-1 overhead can be installed on its own structure or “piggybacked” onto an existing sign structure provided the latter is structurally adequate. Keep in mind that messages conveyed by the HOV signs, such as violation fines and the beginning of a HOV lane downstream, are not necessarily intended only for the HOV vehicle but also for single-occupant vehicles as well.

Guide signs for the HOV facilities are generally used at intermediate ingress/egress locations to inform HOV motorists of upcoming freeway exits and the appropriate location to exit the HOV lane. For direct HOV connectors to and from arterials, guide signs are used in a fashion similar to the standard arterial interchange signing practice. Guide signs follow the standard guide-signing format; white reflective legend on green opaque background and rectangular shape. The exception is the diamond where the white symbol is on a black background. For overhead signs the diamond is placed on the left side and is the full height of the sign panel.

Illumination for overhead signs shall follow the current Caltrans policy for standard guide signs.

Section 5.3 HOV Markings

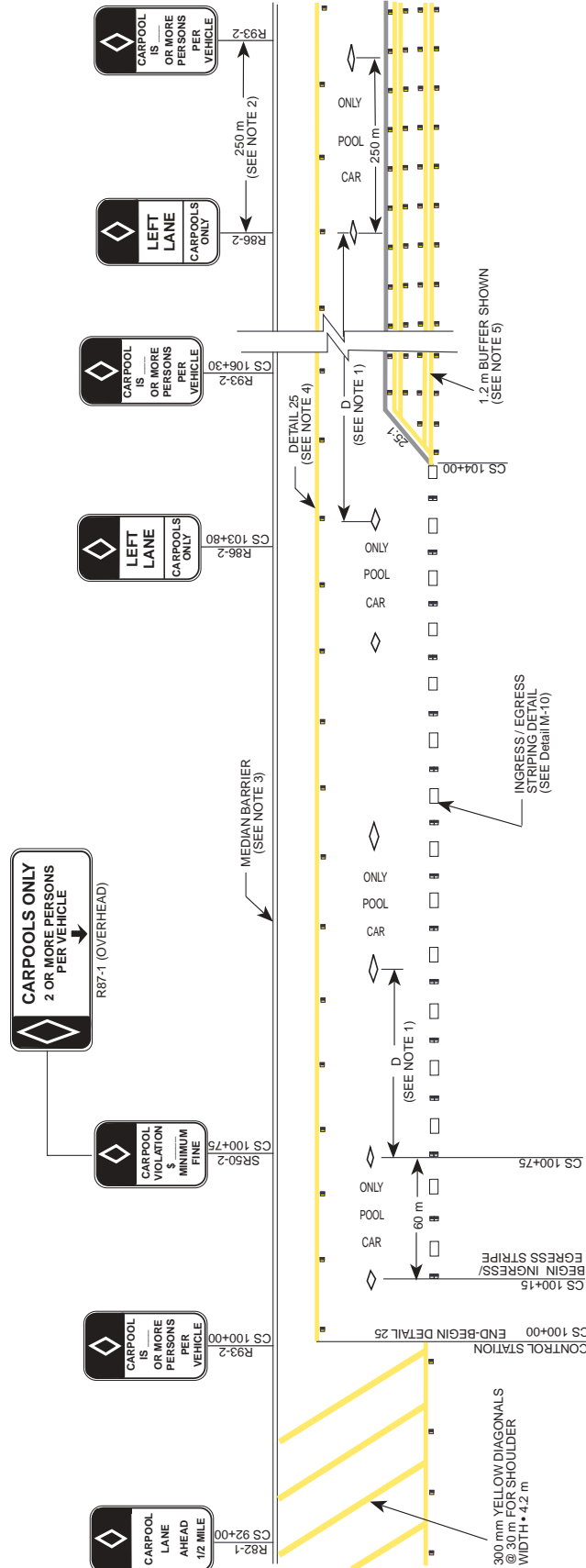
HOV markings, supplemental to signs, are used primarily to differentiate the HOV lane from the adjacent mixed-flow lane and to convey a message that the lane is restricted to HOV’s. Weather and time-of-day variations, particularly during the winter months, are essential considerations in the design of HOV signs and markings since commute hours are the busiest periods for the HOV facilities.

Details M-1 to M-11 provide placement schemes for HOV markings for most HOV scenarios. These schemes are based on applications from the MUTCD and California Supplement to the MUTCD. In some applications, variations are used to address special situations or to enhance safety. In some retrofit situations, which result in a narrow median, the closer spacing of the reflective markers may be more appropriate.

The most simple pavement markings are those associated with the contiguous HOV facility. Because the HOV lane may be reverted to mixed-flow use after the HOV operation, the marking separating the HOV lane and the mixed-flow lane is the lane line pattern used on the majority of freeways. For HOV facilities separated by barriers, the pavement marking also tends to coincide with details from the MUTCD and California Supplement to the MUTCD.

The most complex in terms of markings are those for buffered HOV facilities, mainly used for full-time HOV operation. A combination of reflective markers and solid yellow and white stripes are used to delineate the HOV lane from the adjacent mixed-flow lane, the white stripe is necessary because the California Vehicle Code, Section 21655.8, prohibits driving to the left of double parallel solid lines. To prevent the accidental crossing into the HOV lanes, reflective pavement markers 7.5 meters apart are used to warn errant motorists. All of these combined with the diamond symbol and “carpool only” pavement markings, serve to prevent violations and to inform and warn motorists that the HOV facility is restrictive in nature and should only be used by those who qualify.

TYPICAL HOV SIGNS AND PAVEMENT MARKINGS BEGIN HOV BUFFER-SEPARATED FACILITY (Similar for Barrier-Separated Facilities)

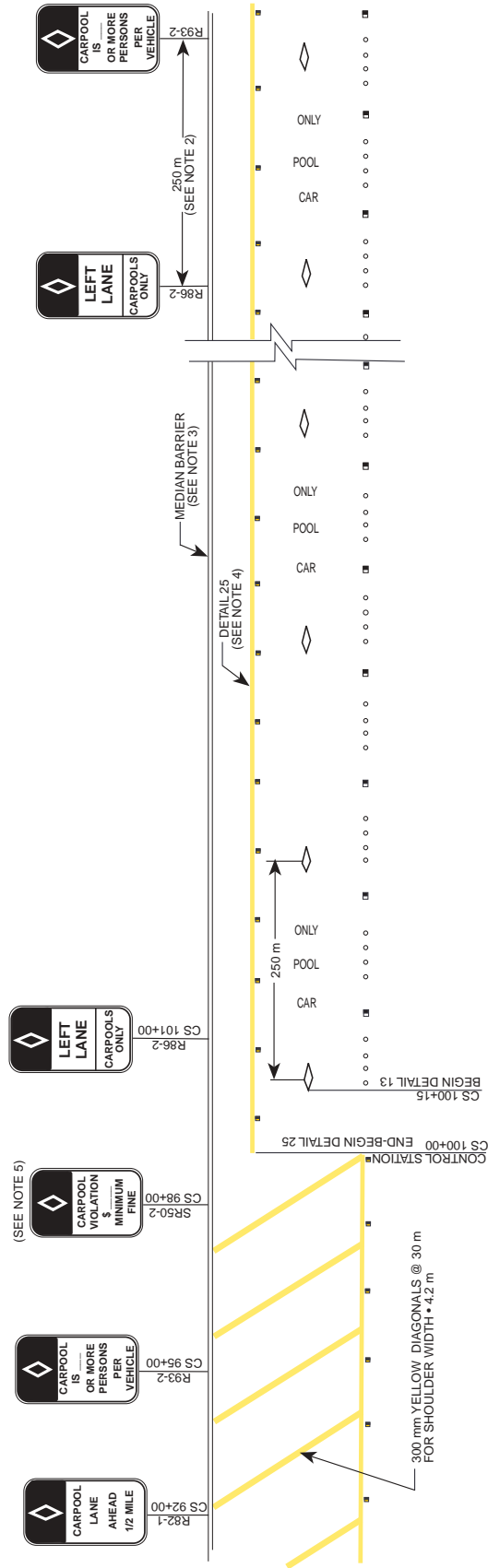


- NOTES:**
1. Repeat Detail M-7 @ D=70 m for 3 times, thereafter repeat Detail M-8 @ D=800 m.
 2. Repeat R86-2 & R93-2 as a package downstream of on-ramps between ingress/egress locations. Repeat R86-2 by itself as needed between long intervals without on-ramps or ingress/egress locations.
 3. Signs placed on the median barrier should not project beyond the median barrier base.
 4. Detail 25A is optional when median width is 1.8 m.
 5. See Figure 5-10 for barrier-separated striping. See Detail M-9 and Detail M-10 for buffer details. Buffer width between 1.2 m and 3.6 m are not to be used.

- LEGEND:**
- NON-REFLECTIVE WHITE MARKER
 - ◻ ONE-WAY CLEAR REFLECTIVE MARKER
 - ◻ ONE-WAY YELLOW REFLECTIVE MARKER
 - ◻ 2 - ONE-WAY CLEAR REFLECTIVE MARKERS
 - ◻ 100 mm WHITE STRIPE (THERMOPLASTIC)
 - ◻ 100 mm YELLOW STRIPE (THERMOPLASTIC)
 - ◻ 200 mm WHITE STRIPE (THERMOPLASTIC)



**TYPICAL HOV SIGNS AND PAVEMENT MARKINGS
BEGIN HOV CONTIGUOUS FACILITY
FULL-TIME OPERATION**

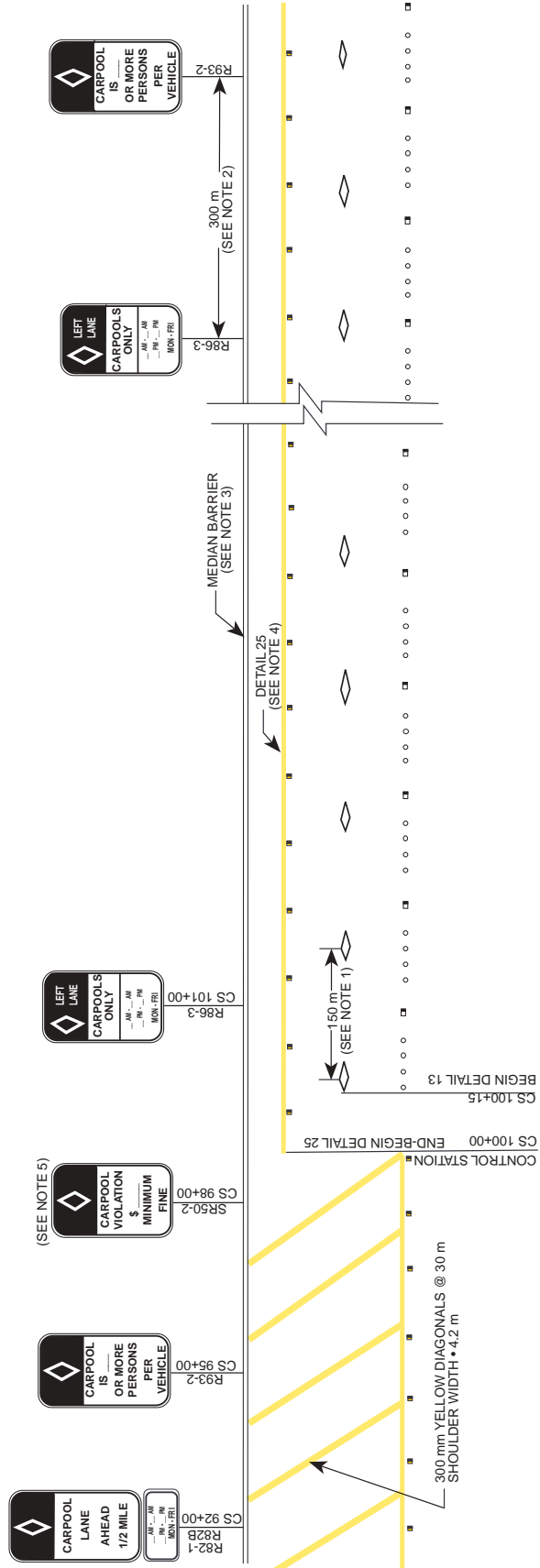


- LEGEND:**
- NON-REFLECTIVE WHITE MARKER
 - ONE-WAY CLEAR REFLECTIVE MARKER
 - ONE-WAY YELLOW REFLECTIVE MARKER
 - 2 - ONE-WAY CLEAR REFLECTIVE MARKERS
 - 100 mm WHITE STRIPE (THERMOPLASTIC)
 - 100 mm YELLOW STRIPE (THERMOPLASTIC)
 - 200 mm WHITE STRIPE (THERMOPLASTIC)

- NOTES:**
1. Repeat Detail M-8 @ 250 m intervals.
 2. Repeat R86-2 & R93-2 as a package at 1000 m intervals and downstream of on-ramps.
 3. Signs placed on the median barrier should not project beyond the median barrier base.
 4. Detail 25A is optional when median width is 1.8 m.
 5. Repeat SR50-2 every 3200 m or as needed at locations experiencing high violation rates.
 6. R87-1 (Overhead) sign is optional. Refer to Detail M-1 for placement.

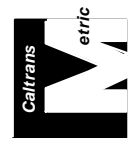


**TYPICAL HOV SIGNS AND PAVEMENT MARKINGS
BEGIN HOV CONTIGUOUS FACILITY
PART-TIME OPERATION**



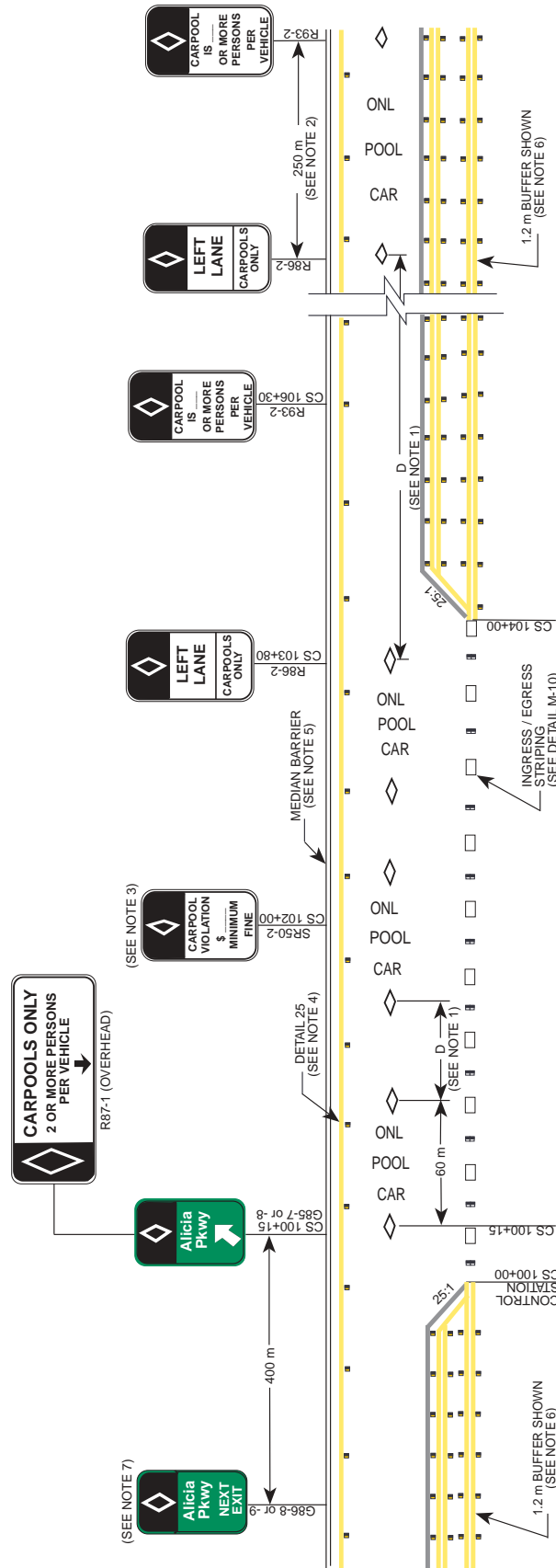
- LEGEND:**
- NON-REFLECTIVE WHITE MARKER
 - ONE-WAY CLEAR REFLECTIVE MARKER
 - ONE-WAY YELLOW REFLECTIVE MARKER
 - ▨ 2 - ONE-WAY CLEAR REFLECTIVE MARKERS
 - ▨ 100 mm WHITE STRIPE (THERMOPLASTIC)
 - ▨ 100 mm YELLOW STRIPE (THERMOPLASTIC)
 - ▨ 200 mm WHITE STRIPE (THERMOPLASTIC)

- NOTES:**
1. Repeat ◊ every 150 m.
 2. Repeat R93-2 & R86-3 as a package at 1000 m intervals and downstream of on-ramps.
 3. Signs placed on the median barrier should not project beyond the median barrier base.
 4. Detail 25A is optional when median width is 1.8 m.
 5. Repeat SR50-2 every 3200 m or as needed at locations experiencing high violation rates.



**DETAIL M-3
NOT TO SCALE**

**TYPICAL HOV SIGNS AND PAVEMENT MARKINGS
TYPICAL INGRESS/EGRESS
FOR HOV FACILITIES WITH BUFFERS 0.3m to 1.2m**

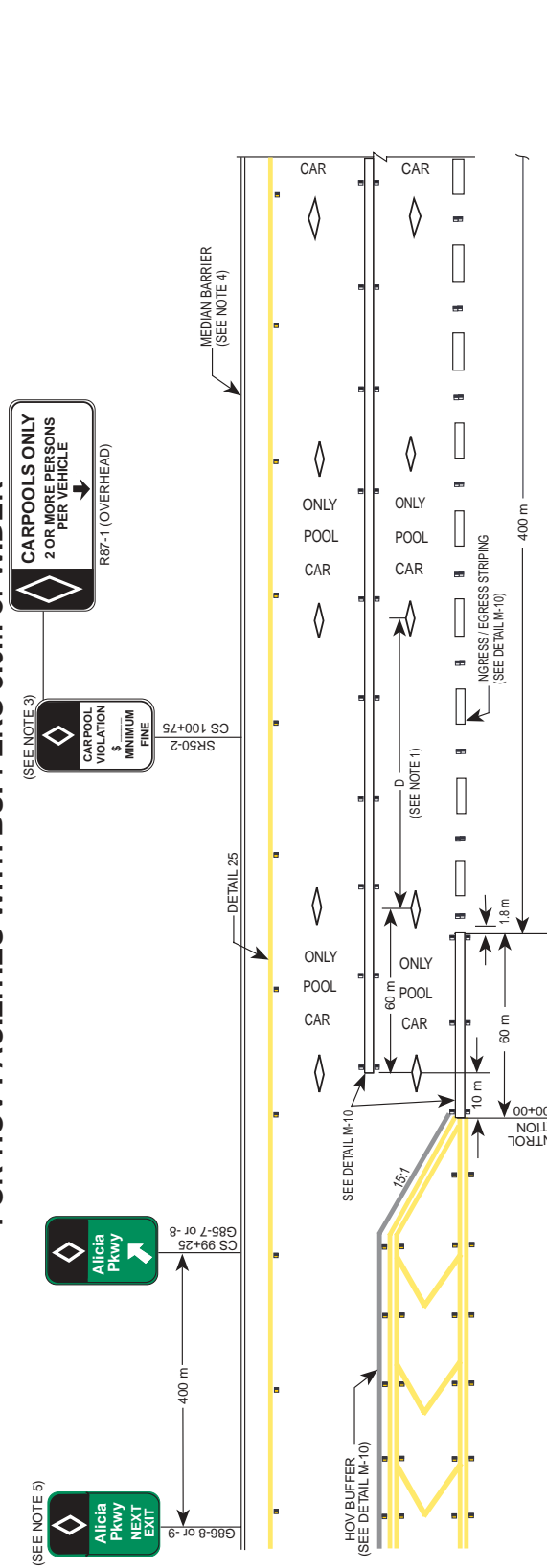


- NOTES:**
1. Repeat Detail M-7 @ D=70 for 3 times, thereafter repeat Detail M-8 @ D=800 m.
 2. Repeat R86-2 & R93-2 as a package downstream of on-ramps between ingress/egress locations. Repeat R86-2 by itself as needed between long intervals without on-ramps or ingress/egress locations.
 3. SR50-2 is optional at ingress/egress locations. However, sign should be placed downstream of heavy HOV generator and freeway to freeway interchanges or as needed at locations experiencing high violation rates.
 4. Detail 25A is optional when median width is 1.8 m.
 5. Signs placed on the median barrier should not project beyond the median barrier base.
 6. See Detail M-10 for barrier-separated striping. See Detail M-9 and Detail M-10 for buffer details. Buffer width between 1.2 m and 3.6 m are not to be used.
 7. The G86-8 or -9 sign should be placed at every ingress/egress location.

- LEGEND:**
- NON-REFLECTIVE WHITE MARKER
 - ONE-WAY CLEAR REFLECTIVE MARKER
 - ONE-WAY YELLOW REFLECTIVE MARKER
 - 2 - ONE-WAY CLEAR REFLECTIVE MARKERS
 - ▭ 100 mm WHITE STRIPE (THERMOPLASTIC)
 - ▭ 100 mm YELLOW STRIPE (THERMOPLASTIC)
 - ▭ 200 mm WHITE STRIPE (THERMOPLASTIC)

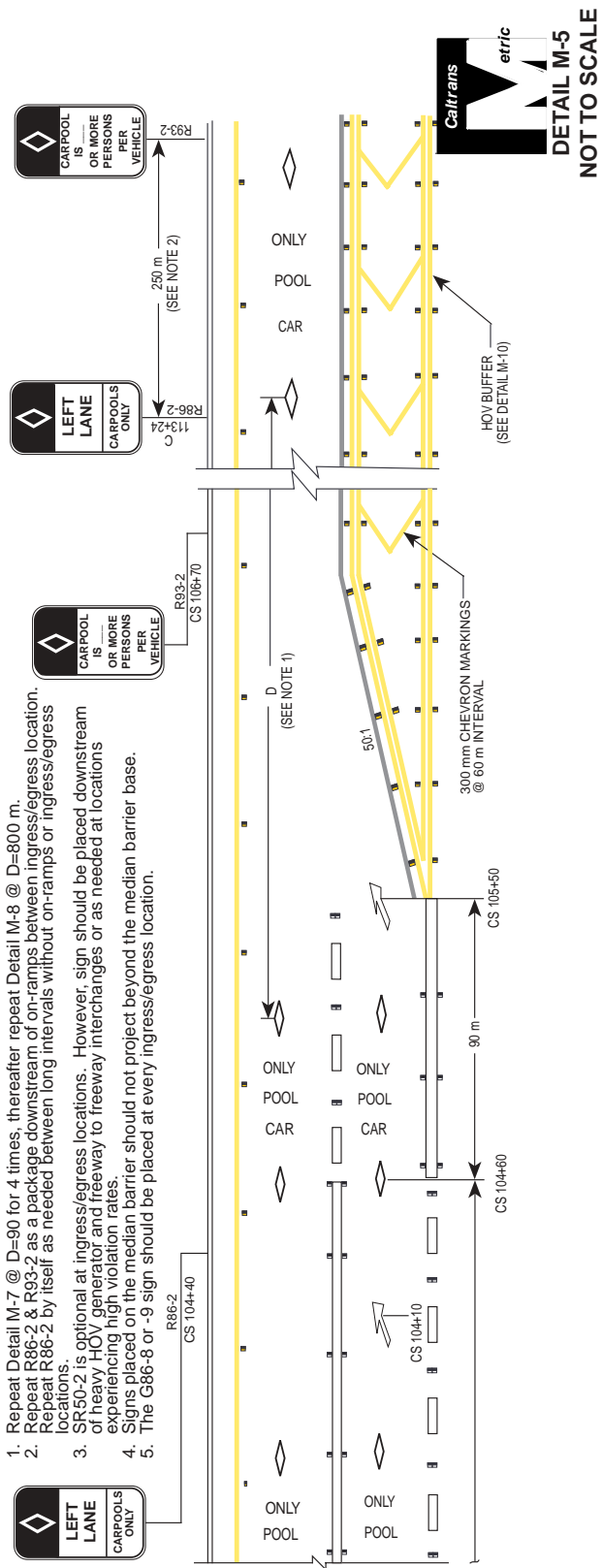


**TYPICAL HOV SIGNS AND PAVEMENT MARKINGS
FOR HOV FACILITIES WITH BUFFERS 3.6m or WIDER**



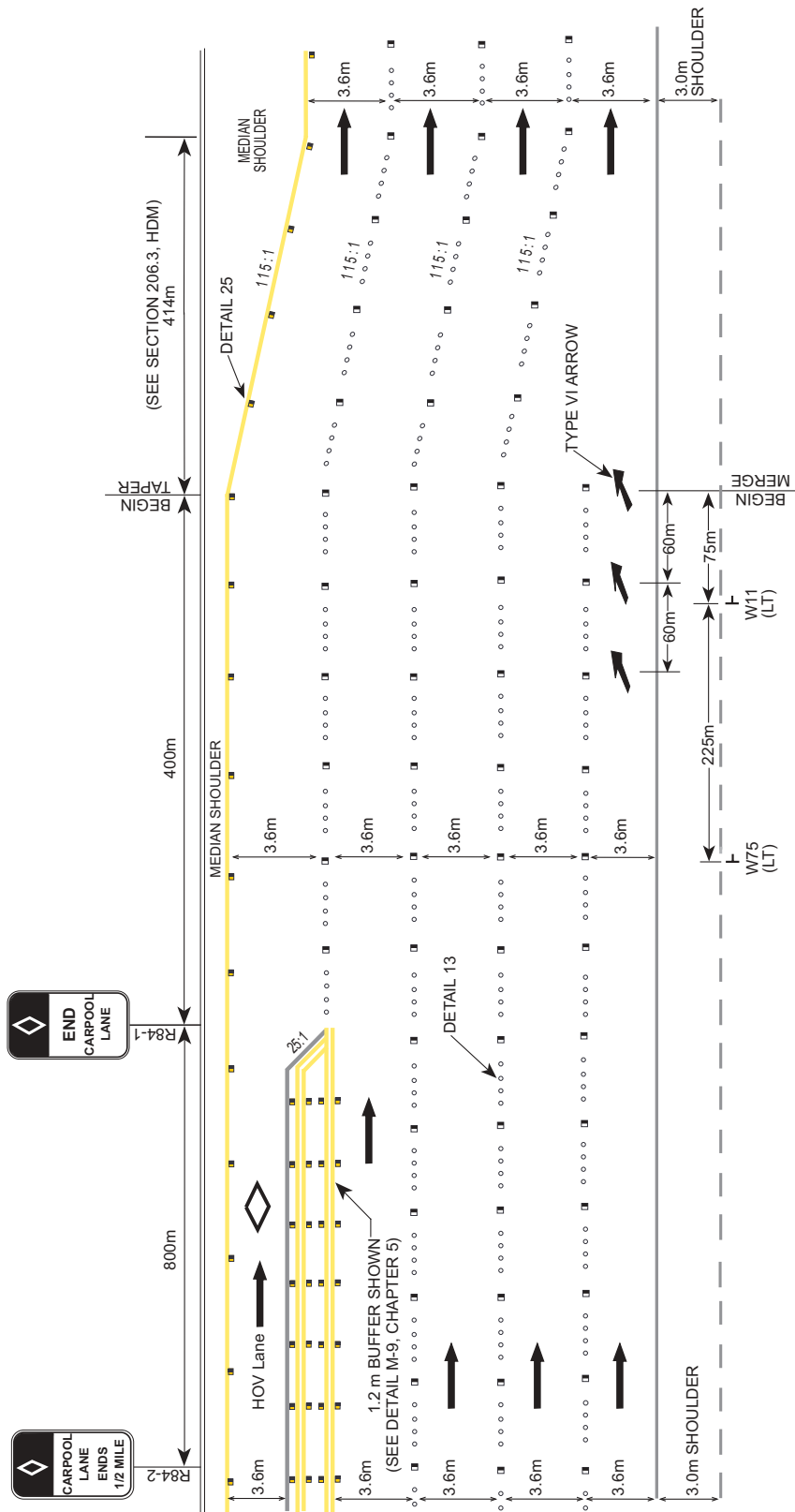
NOTES:

1. Repeat Detail M-7 @ D=90 for 4 times, thereafter repeat Detail M-8 @ D=800 m.
2. Repeat R86-2 & R93-2 as a package downstream of on-ramps between ingress/egress locations.
3. Repeat R86-2 by itself as needed between long intervals without on-ramps or ingress/egress locations.
4. SR50-2 is optional at ingress/egress locations. However, sign should be placed downstream of heavy HOV generator and freeway to freeway interchanges or as needed at locations experiencing high violation rates.
5. Signs placed on the median barrier should not project beyond the median barrier base.
6. The G86-8 or -9 sign should be placed at every ingress/egress location.



**Caltrans M-5
DETAIL M-5
NOT TO SCALE**

TYPICAL HOV SIGNS AND PAVEMENT MARKINGS TYPICAL END HOV LANE (Similar Right Lane Drop for Contiguous and Barrier-Separated Facilities)



NOTES:

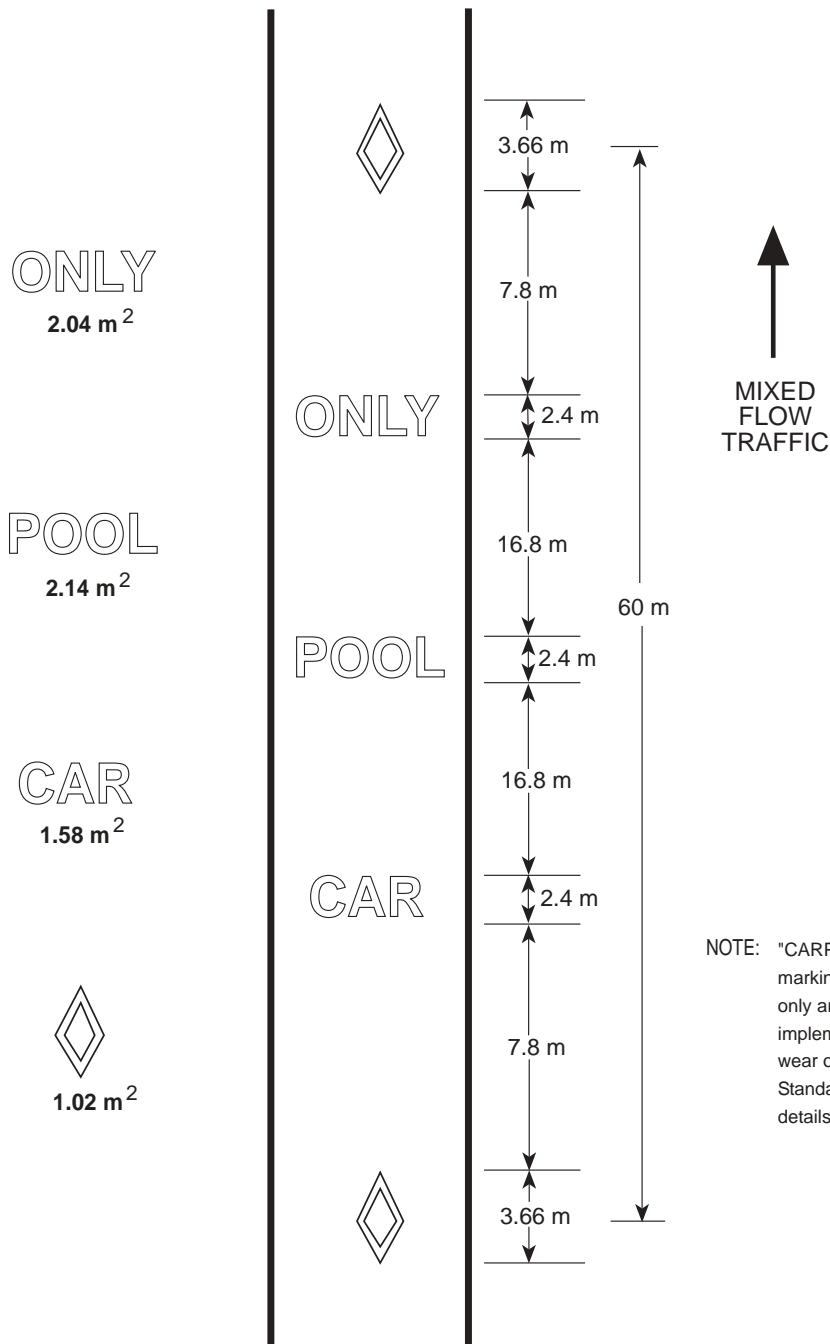
- For details of pavement striping and markings, see the Manual on Uniform Traffic Control Devices (MUTCD) and California Supplement to the MUTCD, which replaces Caltrans' Traffic Manual.
- Refer to Appendices A-4 and A-5: Caltrans, Traffic Operations Memorandum, The Ending of High-Occupancy Vehicle (HOV) Lanes, December 1995.

- LEGEND:**
- NON-REFLECTIVE WHITE MARKER
 - ◻ ONE-WAY CLEAR REFLECTIVE MARKER
 - ◻ ONE-WAY YELLOW REFLECTIVE MARKER
 - ▬ 2 - ONE-WAY CLEAR REFLECTIVE MARKERS
 - ▬ 100 mm WHITE STRIPE (THERMOPLASTIC)
 - ▬ 100 mm YELLOW STRIPE (THERMOPLASTIC)
 - ▬ 200 mm WHITE STRIPE (THERMOPLASTIC)



**DETAIL M-6
NOT TO SCALE**

**TYPICAL HOV SIGNS AND PAVEMENT MARKINGS
TYPICAL HOV LANE PAVEMENT MARKING
FOR BUFFER-SEPARATED (INGRESS/EGRESS) HOV FACILITIES**

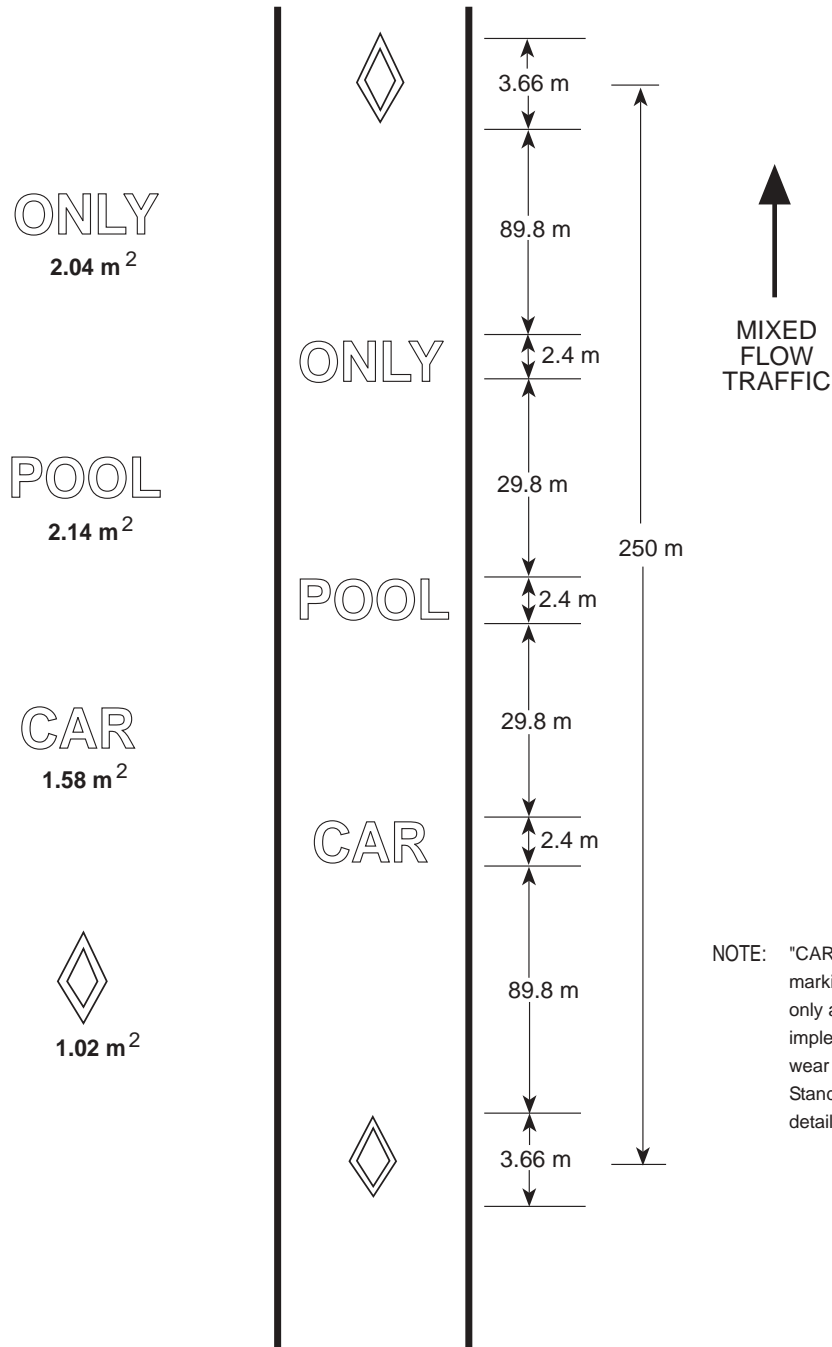


NOTE: "CARPOOL ONLY" pavement markings for full-time HOV facilities only are to be used for initial implementation and then allowed to wear out. See current Caltrans Standard Plans for pavement marking details.



**DETAIL M-7
NOT TO SCALE**

TYPICAL HOV SIGNS AND PAVEMENT MARKINGS
TYPICAL HOV LANE PAVEMENT MARKING

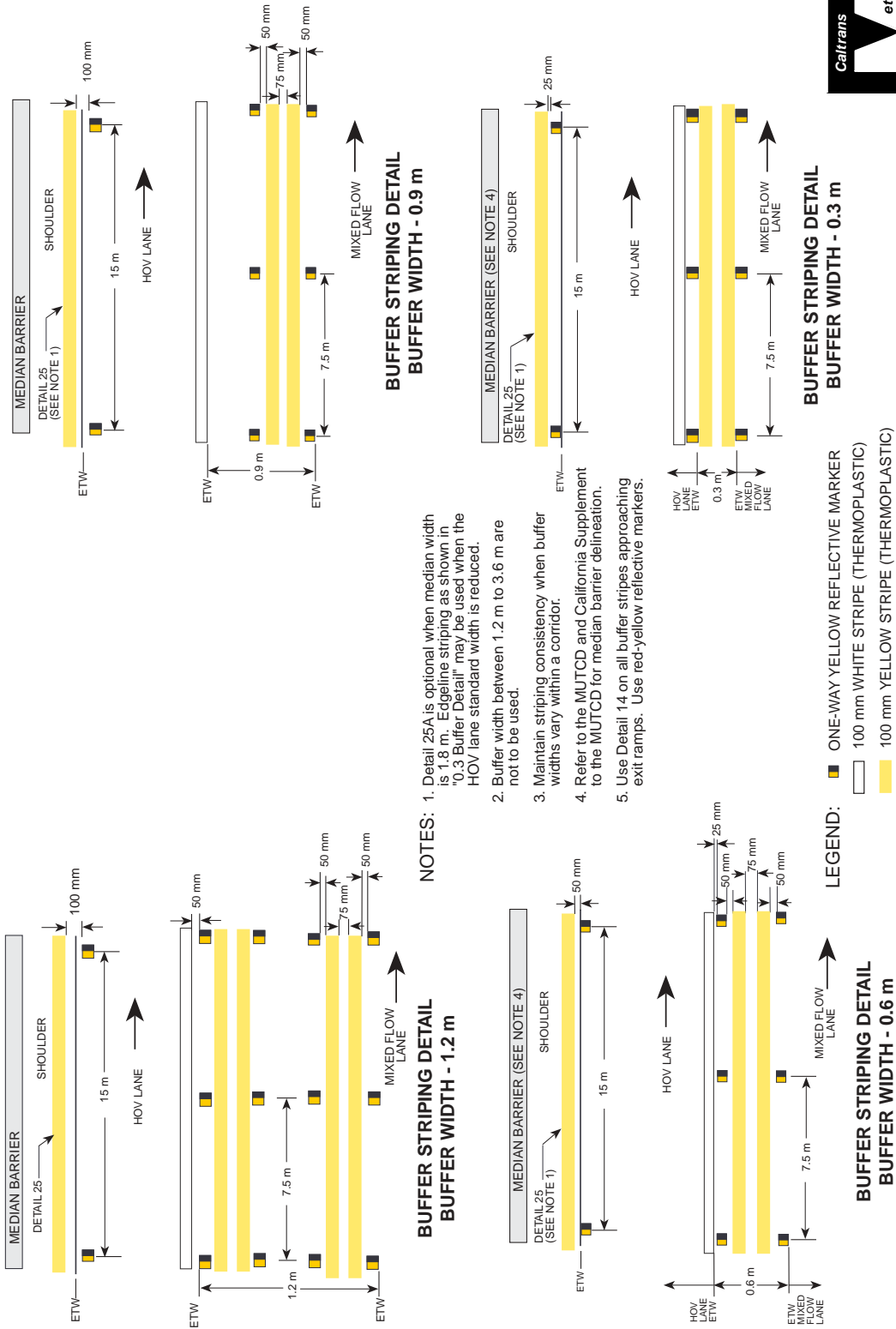


NOTE: "CARPOOL ONLY" pavement markings for full-time HOV facilities only are to be used for initial implementation and then allowed to wear out. See current Caltrans Standard Plans for pavement marking details.

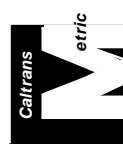


DETAIL M-8
NOT TO SCALE

TYPICAL HOV SIGNS AND PAVEMENT MARKINGS TYPICAL PAVEMENT MARKING DETAIL FOR BUFFER-SEPARATED HOV FACILITIES

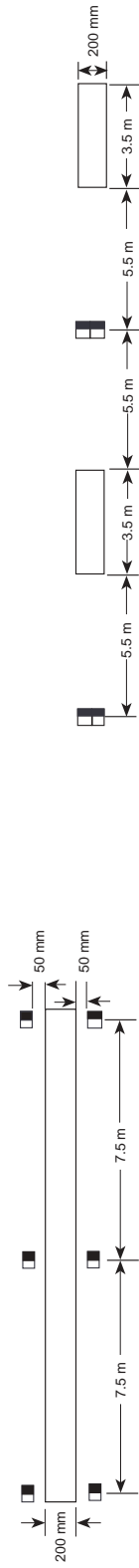


- NOTES:**
1. Detail 25A is optional when median width is 1.8 m. Edgeline striping as shown in "0.3 Buffer Detail" may be used when the HOV lane standard width is reduced.
 2. Buffer width between 1.2 m to 3.6 m are not to be used.
 3. Maintain striping consistency when buffer widths vary within a corridor.
 4. Refer to the MUTCD and California Supplement to the MUTCD for median barrier delineation.
 5. Use Detail 14 on all buffer stripes approaching exit ramps. Use red-yellow reflective markers.

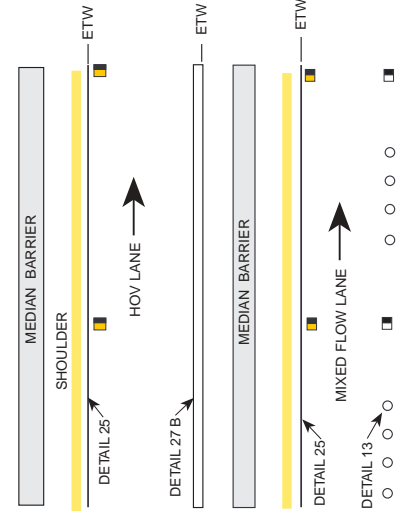


**DETAIL M-9
NOT TO SCALE**

TYPICAL HOV SIGNS AND PAVEMENT MARKINGS TYPICAL PAVEMENT MARKING DETAIL FOR HOV FACILITIES



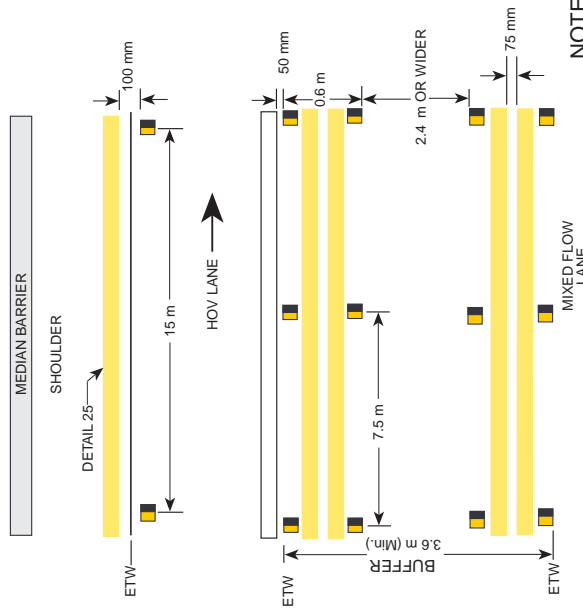
INGRESS / EGRESS STRIPING DETAIL (SEE DETAIL M-1, M-4 & M-5)



BARRIER - SEPARATED STRIPING DETAIL

- LEGEND:**
- NON-REFLECTIVE WHITE MARKER
 - ◻ ONE-WAY CLEAR REFLECTIVE MARKER
 - ◻ ONE-WAY YELLOW REFLECTIVE MARKER
 - ◻ 2 - ONE-WAY CLEAR REFLECTIVE MARKERS
 - ◻ 100 mm WHITE STRIPE (THERMOPLASTIC)
 - ◻ 100 mm YELLOW STRIPE (THERMOPLASTIC)
 - ◻ 200 mm WHITE STRIPE (THERMOPLASTIC)

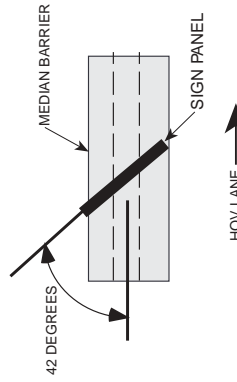
INGRESS / EGRESS STRIPING DETAIL FOR USE WITH BUFFERS 3.6 m OR WIDER (SEE DETAIL M-5)



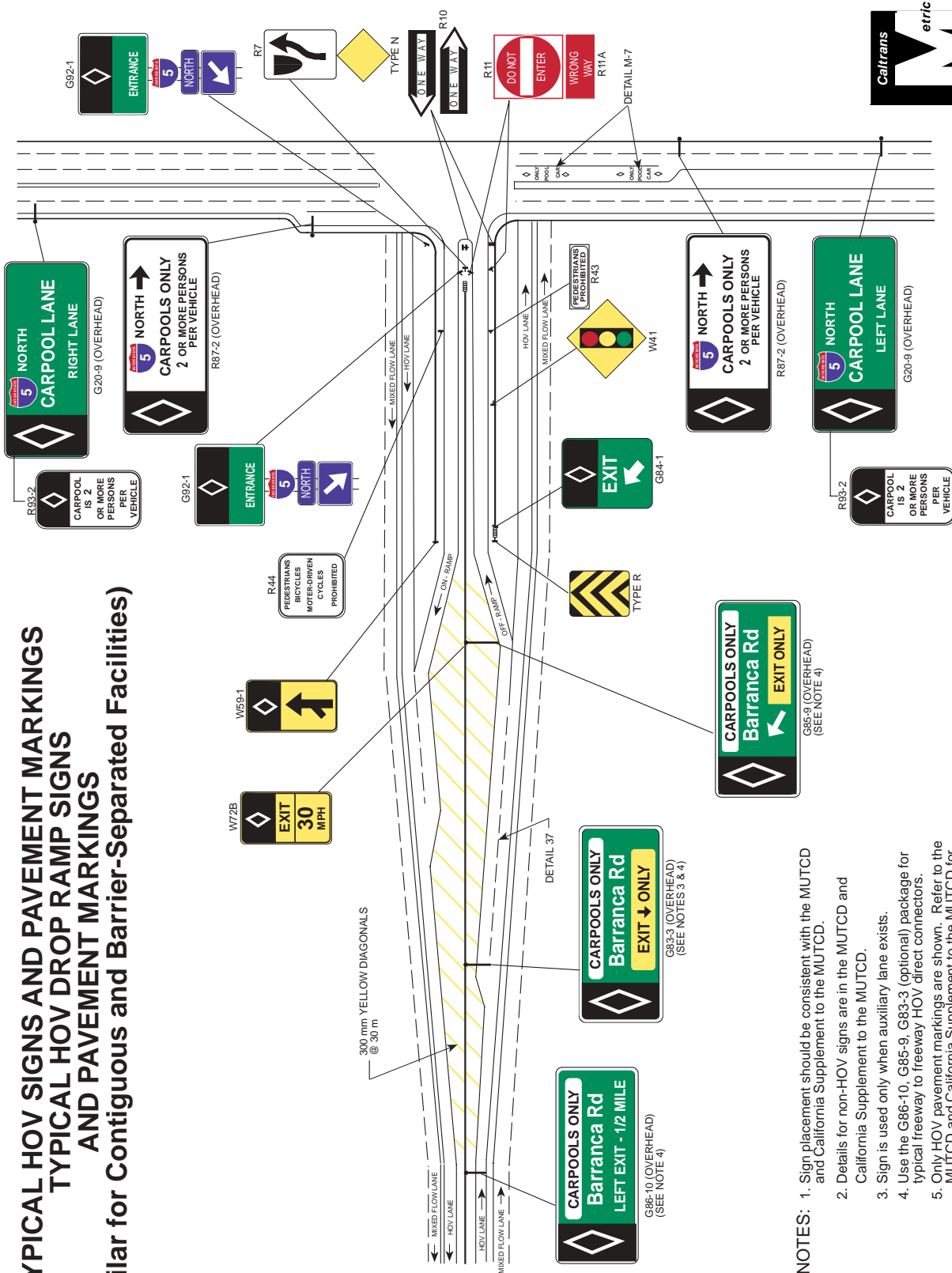
BUFFER STRIPING DETAIL BUFFER WIDTH - 3.6 m OR WIDER

- NOTES:**
1. Maintain striping consistency when buffer widths vary within a corridor.
 2. Use Detail 14 on all buffer stripes approaching exit ramps. Use red-yellow reflective markers.
 3. Maximum sign width is 900 mm when mounted on a median barrier with a base width of 610 mm. Wider panels may be used where signs are not mounted on a barrier.

MAXIMUM ANGLE FOR 900 mm SIGN (SEE NOTE 3)



TYPICAL HOV SIGNS AND PAVEMENT MARKINGS TYPICAL HOV DROP RAMP SIGNS AND PAVEMENT MARKINGS (Similar for Contiguous and Barrier-Separated Facilities)



- NOTES:
1. Sign placement should be consistent with the MUTCD and California Supplement to the MUTCD.
 2. Details for non-HOV signs are in the MUTCD and California Supplement to the MUTCD.
 3. Sign is used only when auxiliary lane exists.
 4. Use the G86-10, G85-9, G83-3 (optional) package for typical freeway to freeway HOV direct connectors.
 5. Only HOV pavement markings are shown. Refer to the MUTCD and California Supplement to the MUTCD for standard markings for ramps.

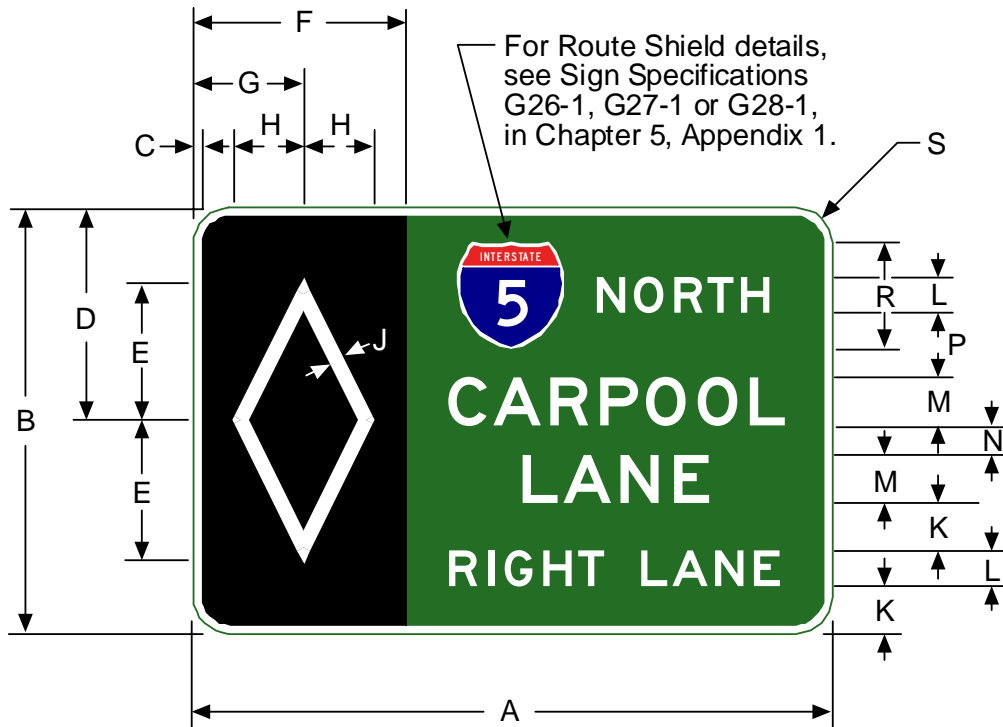


DETAIL M-11
NOT TO SCALE

STATE OF CALIFORNIA - DEPARTMENT OF TRANSPORTATION

MUTCD NUMBER None

CODE G20-9



SIGN SIZE (Inches)	DIMENSIONS (Inches)															
	A	B	C	D	E	F	G	H	J	K	L	M	N	P	R	S
108 x 70	108	70	1-1/2	35	24	36	18-3/4	12	3	8	6E	8E	5	10	18	6
108 x 72	108	72	1-1/2	36	24	36	18-3/4	12	3	8	6E	8E	5	11	18	6

SIGN SIZE (mm)	DIMENSIONS (Millimeters)															
	A	B	C	D	E	F	G	H	J	K	L	M	N	P	R	S
2743 x 1778	2743	1778	38	889	610	914	476	305	76	203	150E	200E	127	254	457	152
2743 x 1829	2743	1829	38	914	610	914	476	305	76	203	150E	200E	127	279	457	152

COLORS
BORDER, LEGEND & DIAMOND - WHITE (REFLECTIVE)
DIAMOND BACKGROUND - BLACK (NON-REFLECTIVE)
BACKGROUND - GREEN (REFLECTIVE)

- THE POLICY FOR INTENDED USAGE OF THIS SIGN IS SHOWN ON REVERSE SIDE -

Gerry Myers
 CHIEF, OFFICE OF SIGNS AND DELINEATION

8/1/02

DATE

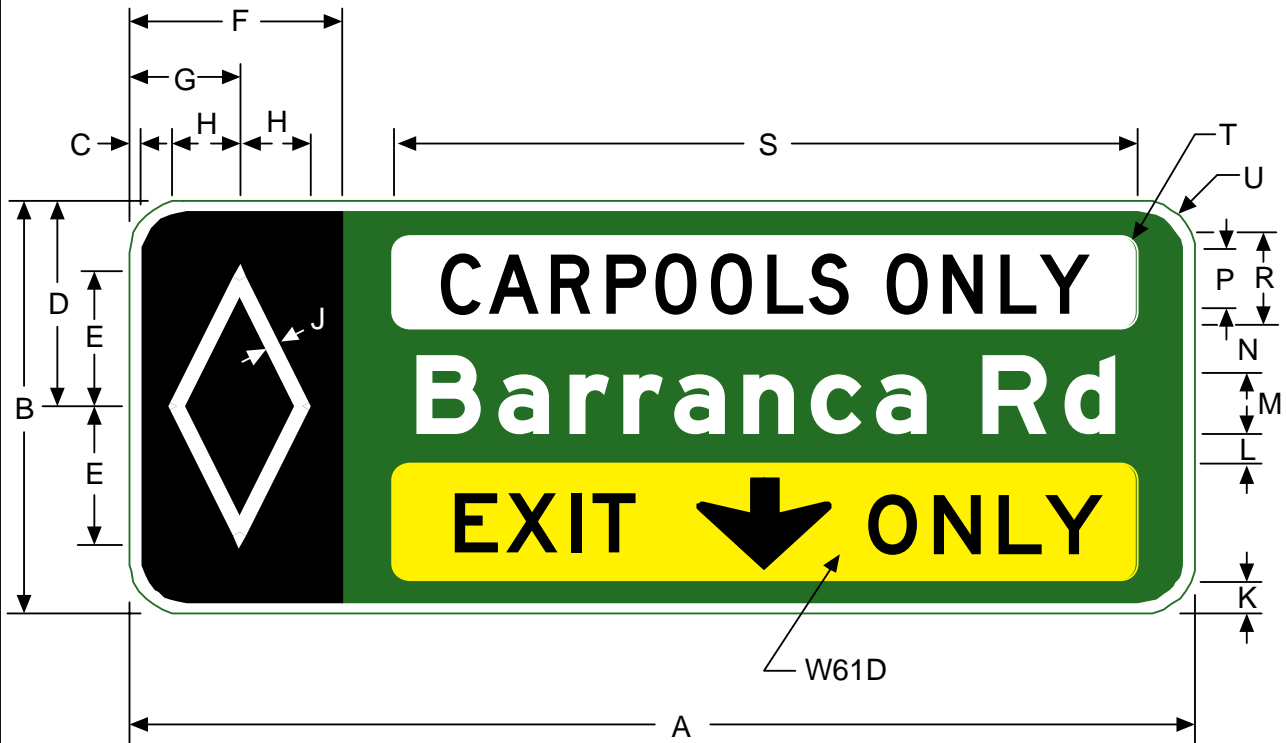
REVISION

REVISION

STATE OF CALIFORNIA - DEPARTMENT OF TRANSPORTATION

MUTCD NUMBER None

CODE G83-3

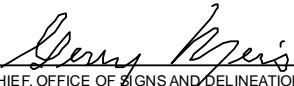


SIGN SIZE (Inches)	DIMENSIONS (Inches)																	
	A	B	C	D	E	F	G	H	J	K	L	M	N	P	R	S	T	U
Variable x 70	Var.	70	2	35	24	36	18-3/4	12	3	5-1/2	5	13.3UC & 10LC	8-1/2	10D	16	126	3	9
Variable x 100	Var.	100	2	50	24	36	18-3/4	12	3	13	11	13.3UC & 10LC	14.3	10D	20	126	3	12

SIGN SIZE (mm)	DIMENSIONS (Millimeters)																	
	A	B	C	D	E	F	G	H	J	K	L	M	N	P	R	S	T	U
Variable x 1778	Var.	1778	51	889	610	914	476	305	76	140	127	330UC & 250LC	216	250D	406	3200	76	229
Variable x 2540	Var.	2540	51	1270	610	914	476	305	76	330	279	330UC & 250LC	363	250D	508	3200	76	305

COLORS
BORDER, LEGEND & DIAMOND - WHITE (REFLECTIVE)
LEGEND ON WHITE BACKGROUND - BLACK (NON-REFLECTIVE)
DIAMOND BACKGROUND - BLACK (NON-REFLECTIVE)
BACKGROUND - GREEN & WHITE (REFLECTIVE)

- THE POLICY FOR INTENDED USAGE OF THIS SIGN IS SHOWN ON REVERSE SIDE -


8/1/02
REVISION
REVISION

CHIEF, OFFICE OF SIGNS AND DELINEATION
DATE
REVISION
REVISION

STATE OF CALIFORNIA - DEPARTMENT OF TRANSPORTATION

MUTCD NUMBER None CODE G84-1

NOTE: For arrow size, see dimensions 'L' (Width), 'M' (Height), and Standard Arrows for Directional Signs in Chapter 5, Appendix 1.

SIGN SIZE (Inches)	DIMENSIONS (Inches)												
	A	B	C	D	E	F	G	H	J	K	L	M	N
36 x 54	36	54	1	18	9-1/2	7-1/2	3-3/4	1-1/8	5	8E	11-1/4	12-3/4	3

SIGN SIZE (mm)	DIMENSIONS (Millimeters)												
	A	B	C	D	E	F	G	H	J	K	L	M	N
914 x 1372	914	1372	25	457	241	191	95	29	127	200E	286	324	76

COLORS
BORDER, LEGEND & DIAMOND - WHITE (REFLECTIVE)
DIAMOND BACKGROUND - BLACK (NON-REFLECTIVE)
BACKGROUND - GREEN (REFLECTIVE)

- THE POLICY FOR INTENDED USAGE OF THIS SIGN IS SHOWN ON REVERSE SIDE -

CHIEF, OFFICE OF SIGNS AND DELINEATION

8/1/02

DATE

REVISION

REVISION

REVISION

REVISION

STATE OF CALIFORNIA - DEPARTMENT OF TRANSPORTATION

MUTCD NUMBER None CODE G85-7

Notes:

1. Series C or D alphabets, abbreviations and hyphenations may be used to maintain minimum sign widths. Smaller letter heights, 4" (100 mm) minimum, may be used as a last option.
2. For arrow size and dimensions, see Standard Arrows for Directional Signs in Chapter 5, Appendix 1.

SIGN SIZE (Inches)	DIMENSIONS (Inches)												
	A	B	C	D	E	F	G	H	J	K	L	M	N
Variable x 60	Var.	60	1	18	9-1/2	7-1/2	3-3/4	1-1/8	7-1/2	6UC&4-1/2LC	6	4-1/2	3
Variable x 72	Var.	72	1-1/4	18	9-5/8	7-1/2	3-3/4	1-1/8	10	8UC&6LC	8	6	6

SIGN SIZE (mm)	DIMENSIONS (Millimeters)												
	A	B	C	D	E	F	G	H	J	K	L	M	N
Variable x 1524	Var.	1524	25	457	241	191	95	29	191	150UC&113LC	152	114	76
Variable x 1829	Var.	1829	32	457	244	191	95	29	254	200UC&150LC	203	152	152

COLORS
BORDER, LEGEND & DIAMOND - WHITE (REFLECTIVE)
DIAMOND BACKGROUND - BLACK (NON-REFLECTIVE)
BACKGROUND - GREEN (REFLECTIVE)
 - THE POLICY FOR INTENDED USAGE OF THIS SIGN IS SHOWN ON REVERSE SIDE -

CHIEF, OFFICE OF SIGNS AND DELINEATION

8/1/02

DATE

REVISION

REVISION

STATE OF CALIFORNIA - DEPARTMENT OF TRANSPORTATION

MUTCD NUMBER None CODE G85-8

Notes:

1. Series C or D alphabets, abbreviations and hyphenations may be used to maintain minimum sign widths. Smaller letter heights, 4" (100 mm) minimum, may be used as a last option.
2. For arrow size and dimensions, see Standard Arrows for Directional Signs in Chapter 5, Appendix 1.

SIGN SIZE (Inches)	DIMENSIONS (Inches)												
	A	B	C	D	E	F	G	H	J	K	L	M	N
Variable x 72	Var.	72	1	18	9-1/2	7-1/2	3-3/4	1-1/8	8	6UC&4-1/2LC	6	4-1/2	3
Variable x 84	Var.	84	1-1/4	18	9-5/8	7-1/2	3-3/4	1-1/8	10	8UC&6LC	8	6	6

SIGN SIZE (mm)	DIMENSIONS (Millimeters)												
	A	B	C	D	E	F	G	H	J	K	L	M	N
Variable x 1829	Var.	1829	25	457	241	191	95	29	203	150UC&113LC	152	114	76
Variable x 2134	Var.	2134	32	457	244	191	95	29	254	200UC&150LC	203	152	152

COLORS
BORDER, LEGEND & DIAMOND - WHITE (REFLECTIVE)
DIAMOND BACKGROUND - BLACK (NON-REFLECTIVE)
BACKGROUND - GREEN (REFLECTIVE)
 - THE POLICY FOR INTENDED USAGE OF THIS SIGN IS SHOWN ON REVERSE SIDE -

CHIEF, OFFICE OF SIGNS AND DELINEATION

8/1/02

DATE

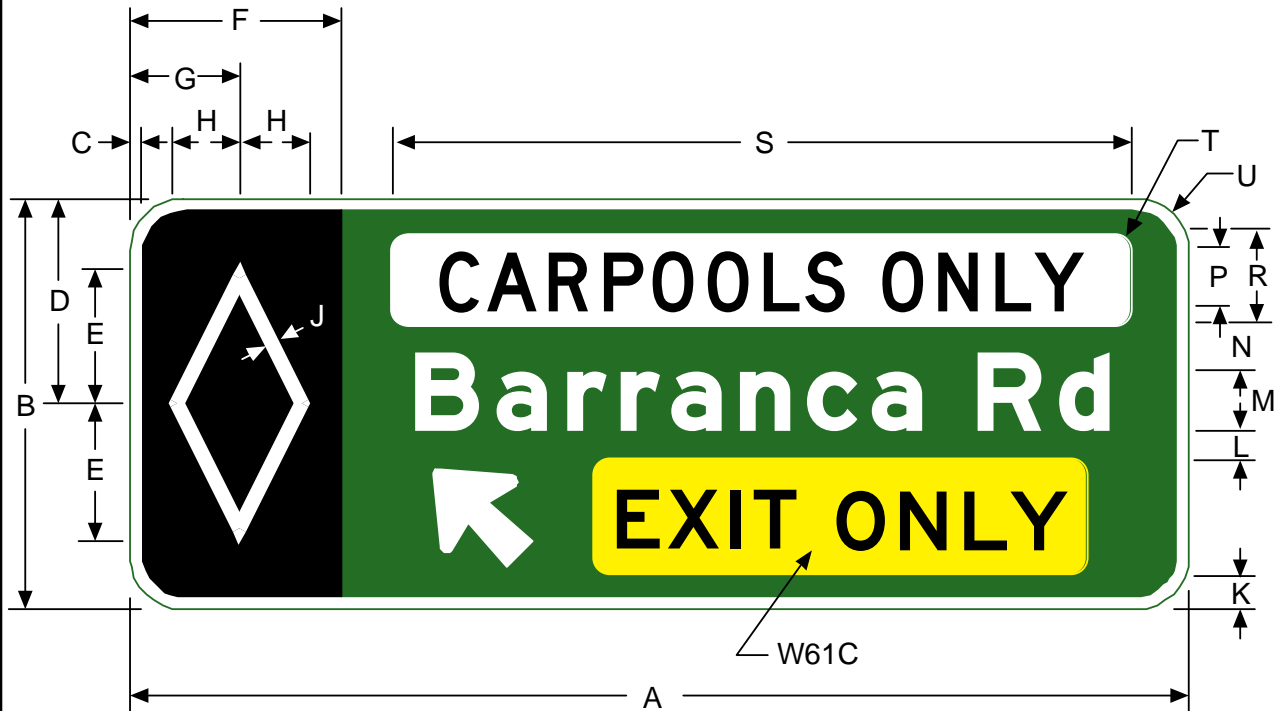
REVISION

REVISION

STATE OF CALIFORNIA - DEPARTMENT OF TRANSPORTATION

MUTCD NUMBER None

CODE G85-9



Note:
For arrow size and dimensions, see Standard Arrows for Directional Signs in Chapter 5, Appendix 1.

SIGN SIZE (Inches)	DIMENSIONS (Inches)																	
	A	B	C	D	E	F	G	H	J	K	L	M	N	P	R	S	T	U
Variable x 70	Var.	70	2	35	24	36	18-3/4	12	3	5-1/2	5	13.3UC & 10LC	8-1/2	10D	16	126	3	9
Variable x 100	Var.	100	2	50	24	36	18-3/4	12	3	13	11	13.3UC & 10LC	14.3	10D	20	126	3	12

SIGN SIZE (mm)	DIMENSIONS (Millimeters)																	
	A	B	C	D	E	F	G	H	J	K	L	M	N	P	R	S	T	U
Variable x 1778	Var.	1778	51	889	610	914	476	305	76	140	127	330UC & 250LC	216	250D	406	3200	76	229
Variable x 2540	Var.	2540	51	1270	610	914	476	305	76	330	279	330UC & 250LC	363	250D	508	3200	76	305

COLORS
BORDER, LEGEND & DIAMOND - WHITE (REFLECTIVE)
LEGEND ON WHITE BACKGROUND - BLACK (NON-REFLECTIVE)
DIAMOND BACKGROUND - BLACK (NON-REFLECTIVE)
BACKGROUND - GREEN & WHITE (REFLECTIVE)

- THE POLICY FOR INTENDED USAGE OF THIS SIGN IS SHOWN ON REVERSE SIDE -

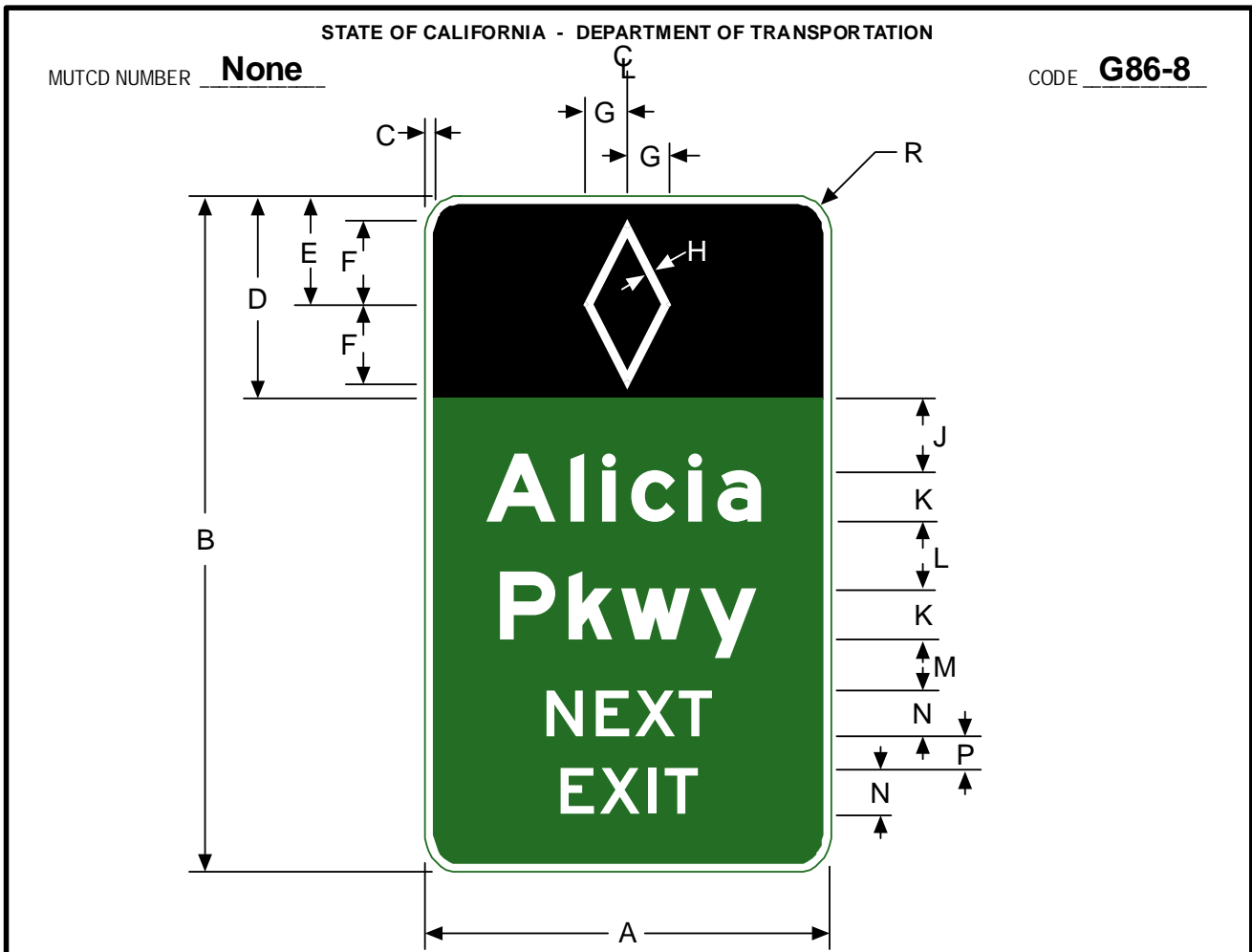
Gerry Kiper
 CHIEF, OFFICE OF SIGNS AND DELINEATION

8/1/02

DATE

REVISION

REVISION



Note: Series C or D alphabets, abbreviations and hyphenations may be used for the primary message to maintain minimum sign widths. Smaller letter heights, 4" (100 mm) minimum, may be considered as a last option.

SIGN SIZE (Inches)	DIMENSIONS (Inches)														
	A	B	C	D	E	F	G	H	J	K	L	M	N	P	R
Variable x 60	Var.	60	1	18	9-1/2	7-1/2	3-3/4	1-1/8	6-1/2	6UC&4-1/2LC	6	4-1/2	4E	3	3
Variable x 78	Var.	78	1-1/4	18	9-5/8	7-1/2	3-3/4	1-1/8	8-1/2	8UC&6LC	8	7	6E	5	6

SIGN SIZE (mm)	DIMENSIONS (Millimeters)														
	A	B	C	D	E	F	G	H	J	K	L	M	N	P	R
Variable x 1524	Var.	1524	25	457	241	191	95	29	165	150UC&113LC	152	114	100E	76	76
Variable x 1981	Var.	1981	32	457	244	191	95	29	216	200UC&150LC	203	178	150E	127	152

COLORS
BORDER, LEGEND & DIAMOND - WHITE (REFLECTIVE)
DIAMOND BACKGROUND - BLACK (NON-REFLECTIVE)
BACKGROUND - GREEN (REFLECTIVE)
 - THE POLICY FOR INTENDED USAGE OF THIS SIGN IS SHOWN ON REVERSE SIDE -

Gerry Krueger
 CHIEF, OFFICE OF SIGNS AND DELINEATION

8/1/02
 DATE

REVISION

REVISION

STATE OF CALIFORNIA - DEPARTMENT OF TRANSPORTATION


MUTCD NUMBER None CODE G86-9

Note:
Series C or D alphabets, abbreviations and hyphenations may be used for the primary message to maintain minimum sign widths. Smaller letter heights, 4" (100 mm) minimum, may be used as a last option.

SIGN SIZE (Inches)	DIMENSIONS (Inches)														
	A	B	C	D	E	F	G	H	J	K	L	M	N	P	R
Variable x 72	Var.	72	1	18	9-1/2	7-1/2	3-3/4	1-1/8	6-1/2	6UC&4-1/2LC	6	4-1/2	4E	3	3
Variable x 90	Var.	90	1-1/4	18	9-5/8	7-1/2	3-3/4	1-1/8	8	8UC&6LC	8	6	6E	5	6

SIGN SIZE (mm)	DIMENSIONS (Millimeters)														
	A	B	C	D	E	F	G	H	J	K	L	M	N	P	R
Variable x 1829	Var.	1829	25	457	241	191	95	29	165	150UC&113LC	152	114	100E	76	76
Variable x 2286	Var.	2286	32	457	244	191	95	29	203	200UC&150LC	203	152	150E	127	152

COLORS
BORDER, LEGEND & DIAMOND - WHITE (REFLECTIVE)
DIAMOND BACKGROUND - BLACK (NON-REFLECTIVE)
BACKGROUND - GREEN (REFLECTIVE)
 - THE POLICY FOR INTENDED USAGE OF THIS SIGN IS SHOWN ON REVERSE SIDE -


 CHIEF, OFFICE OF SIGNS AND DELINEATION

8/1/02
 DATE

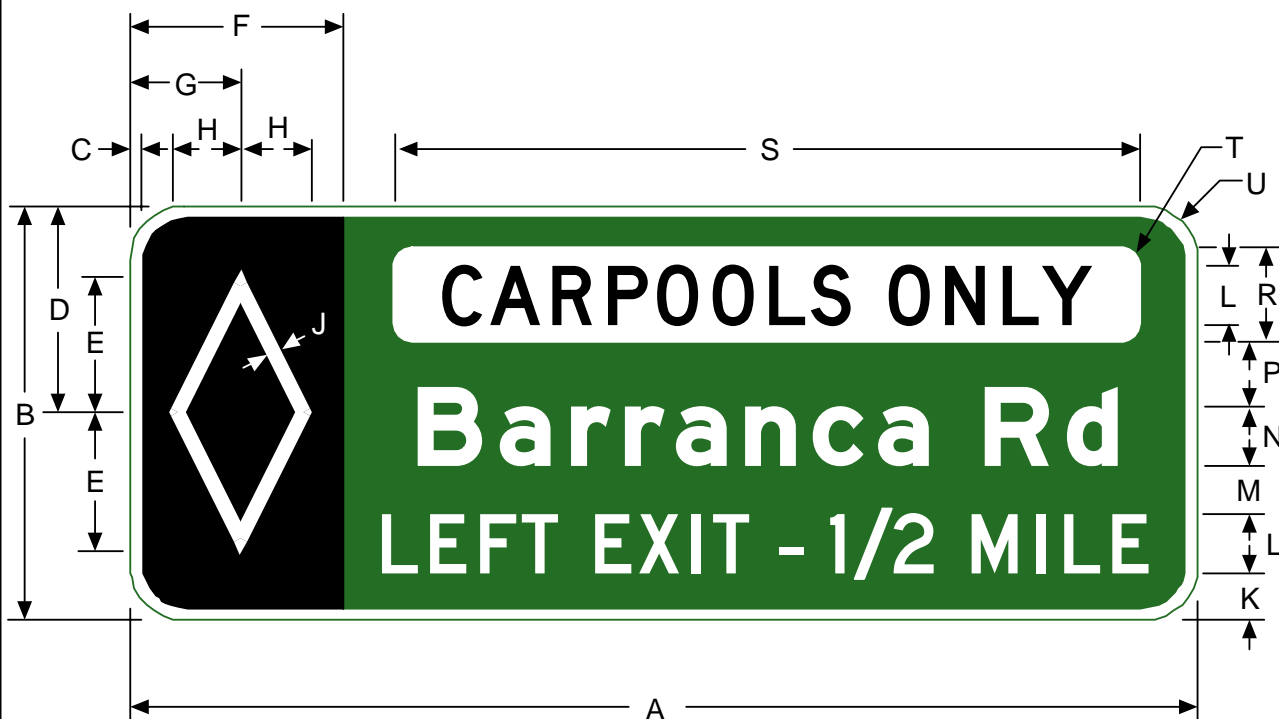
REVISION

REVISION

STATE OF CALIFORNIA - DEPARTMENT OF TRANSPORTATION

MUTCD NUMBER None

CODE G86-10



SIGN SIZE (Inches)	DIMENSIONS (Inches)																	
	A	B	C	D	E	F	G	H	J	K	L	M	N	P	R	S	T	U
Variable x 70	Var.	70	2	35	24	36	18-3/4	12	3	8	10D	8	13.3UC & 10LC	11	16	126	3	9
Variable x 100	Var.	100	2	50	24	36	18-3/4	12	3	15	10D	14	13.3UC & 10LC	17	20	126	3	12

SIGN SIZE (mm)	DIMENSIONS (Millimeters)																	
	A	B	C	D	E	F	G	H	J	K	L	M	N	P	R	S	T	U
Variable x 1778	Var.	1778	51	889	610	914	476	305	76	203	250D	203	330UC & 250LC	279	406	3200	76	229
Variable x 2540	Var.	2540	51	1270	610	914	476	305	76	381	250D	356	330UC & 250LC	432	508	3200	76	305

COLORS
BORDER, LEGEND & DIAMOND - WHITE (REFLECTIVE)
LEGEND ON WHITE BACKGROUND - BLACK (NON-REFLECTIVE)
DIAMOND BACKGROUND - BLACK (NON-REFLECTIVE)
BACKGROUND - GREEN & WHITE (REFLECTIVE)

- THE POLICY FOR INTENDED USAGE OF THIS SIGN IS SHOWN ON REVERSE SIDE -

George K. [Signature]
 CHIEF, OFFICE OF SIGNS AND DELINEATION

8/1/02
 DATE

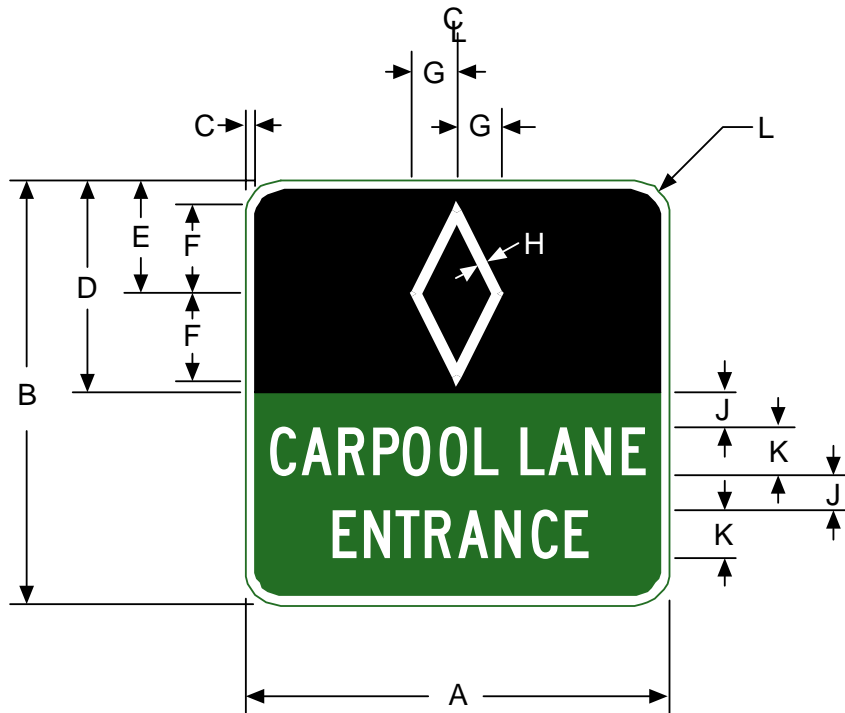
REVISION

REVISION

STATE OF CALIFORNIA - DEPARTMENT OF TRANSPORTATION

MUTCD NUMBER None

CODE G92-1



SIGN SIZE (Inches)	DIMENSIONS (Inches)										
	A	B	C	D	E	F	G	H	J	K	L
36 x 36	36	36	1/2	18	9-1/2	7-1/2	3-3/4	1-1/8	3	4C	1-1/2
48 x 42	48	42	3/4	18	9-3/8	7-1/2	3-3/4	1-1/8	4	5C	1-7/8

SIGN SIZE (mm)	DIMENSIONS (Millimeters)										
	A	B	C	D	E	F	G	H	J	K	L
914 x 914	914	914	13	457	241	191	95	29	76	100C	38
1219 x 1067	1219	1067	19	457	238	191	95	29	102	125C	48

COLORS
BORDER, LEGEND & DIAMOND - WHITE (REFLECTIVE)
DIAMOND BACKGROUND - BLACK (NON-REFLECTIVE)
BACKGROUND - GREEN (REFLECTIVE)

- THE POLICY FOR INTENDED USAGE OF THIS SIGN IS SHOWN ON REVERSE SIDE -

George K. ...
 CHEF, OFFICE OF SIGNS AND DELINEATION

8/1/02

DATE

REVISION

REVISION

STATE OF CALIFORNIA - DEPARTMENT OF TRANSPORTATION

MUTCD NUMBER None CODE R82-1

SIGN SIZE (Inches)	DIMENSIONS (Inches)												
	A	B	C	D	E	F	G	H	J	K	L	M	N
30 x 60	30	60	1/2	3/4	18	9-1/4	7-1/2	3-3/4	1-1/8	5	5C	3-1/2	1-7/8
36 x 66	36	66	5/8	7/8	18	9-5/16	7-1/2	3-3/4	1-1/8	5	6C	4	2-1/4
48 x 84	48	84	3/4	1-1/4	18	9-3/8	7-1/2	3-3/4	1-1/8	7	8C	6	3

SIGN SIZE (mm)	DIMENSIONS (Millimeters)												
	A	B	C	D	E	F	G	H	J	K	L	M	N
762 x 1524	762	1524	13	19	450	235	191	95	29	127	125C	89	48
914 x 1676	914	1676	16	22	450	237	191	95	29	127	150C	102	57
1219 x 2134	1219	2134	19	31	450	238	191	95	29	178	200C	152	76

COLORS
BORDER, LEGEND & DIAMOND BACKGROUND - BLACK (NON-REFLECTIVE)
DIAMOND & BACKGROUND - WHITE (REFLECTIVE)

- THE POLICY FOR INTENDED USAGE OF THIS SIGN IS SHOWN ON REVERSE SIDE -

CHIEF, OFFICE OF SIGNS AND DELINEATION

8/1/02

DATE

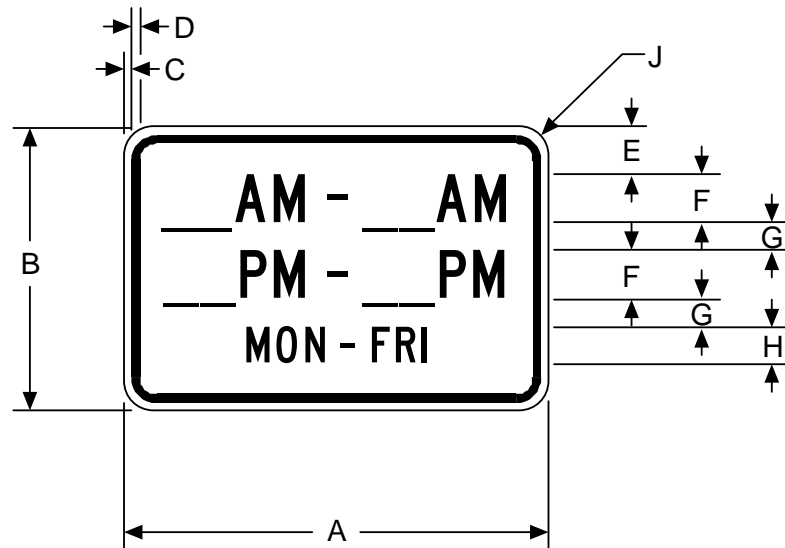
REVISION

REVISION

STATE OF CALIFORNIA - DEPARTMENT OF TRANSPORTATION

MUTCD NUMBER None

CODE R82B



NOTE: Specify times when ordering.

SIGN SIZE (Inches)	DIMENSIONS (Inches)									
	A	B	C	D	E	F	G	H	J	
30 x 24	30	24	1/2	3/4	4	4C	2-1/2	3C	1-7/8	
36 x 24	36	24	5/8	7/8	4	4D	2-1/2	3D	2-1/4	
48 x 36	48	36	3/4	1-1/4	5	6D	4	4D	3	

SIGN SIZE (mm)	DIMENSIONS (Millimeters)									
	A	B	C	D	E	F	G	H	J	
762 x 610	762	610	13	19	102	100C	64	75C	48	
914 x 610	914	610	16	22	102	100D	64	75D	57	
1219 x 914	1219	914	19	31	127	150D	102	100D	76	

COLORS
BORDER & LEGEND - BLACK (NON-REFLECTIVE)
BACKGROUND - WHITE (REFLECTIVE)

- THE POLICY FOR INTENDED USAGE OF THIS SIGN IS SHOWN ON REVERSE SIDE -

George Myers
 CHIEF, OFFICE OF SIGNS AND DELINEATION

8/1/02

DATE

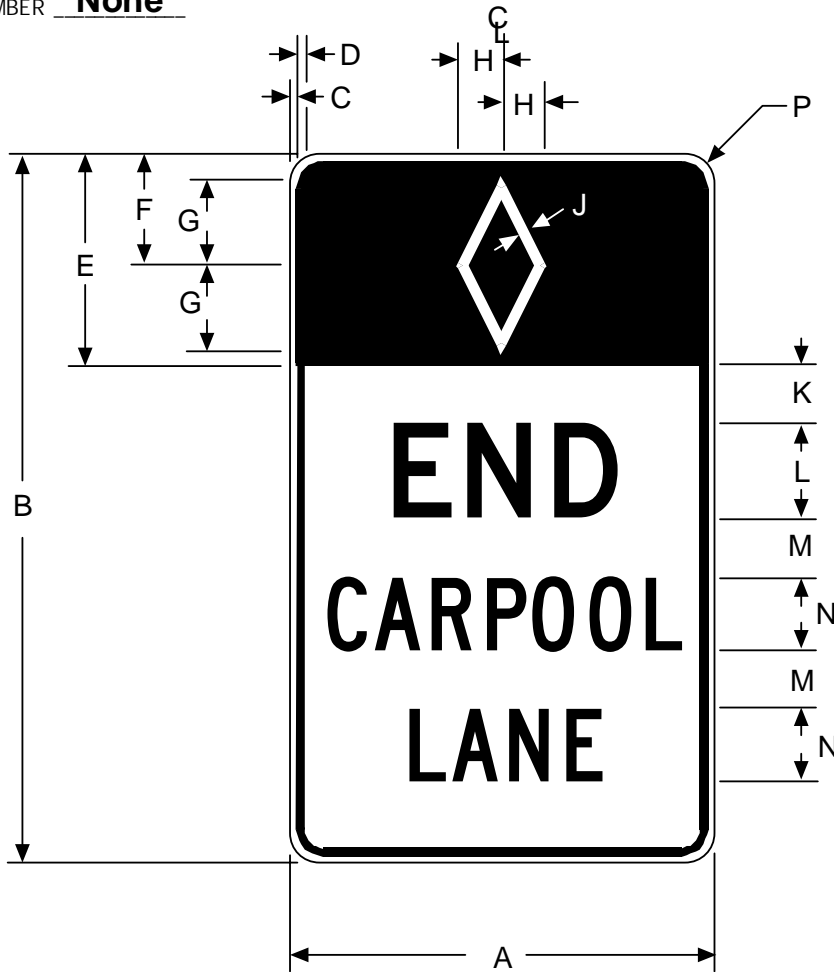
REVISION

REVISION

STATE OF CALIFORNIA - DEPARTMENT OF TRANSPORTATION

MUTCD NUMBER None

CODE R84-1



SIGN SIZE (Inches)	DIMENSIONS (Inches)													
	A	B	C	D	E	F	G	H	J	K	L	M	N	P
30 x 54	30	54	1/2	3/4	18	9-1/4	7-1/2	3-3/4	1-1/8	5	6D	4	5C	1-7/8
36 x 60	36	60	5/8	7/8	18	9-5/16	7-1/2	3-3/4	1-1/8	5	8D	5	6C	2-1/4
48 x 72	48	72	3/4	1-1/4	18	9-3/8	7-1/2	3-3/4	1-1/8	7	10D	6	8C	3

SIGN SIZE (mm)	DIMENSIONS (Millimeters)													
	A	B	C	D	E	F	G	H	J	K	L	M	N	P
762 x 1372	762	1372	13	19	450	235	191	95	29	127	150D	102	125C	48
914 x 1524	914	1524	16	22	450	237	191	95	29	127	200D	127	150C	57
1219 x 1829	1219	1829	19	31	450	238	191	95	29	178	250D	152	200C	76

COLORS
BORDER, LEGEND & DIAMOND BACKGROUND - BLACK (NON-REFLECTIVE)
DIAMOND & BACKGROUND - WHITE (REFLECTIVE)

- THE POLICY FOR INTENDED USAGE OF THIS SIGN IS SHOWN ON REVERSE SIDE -

Gerry Myers
 CHIEF, OFFICE OF SIGNS AND DELINEATION

8/1/02
 DATE

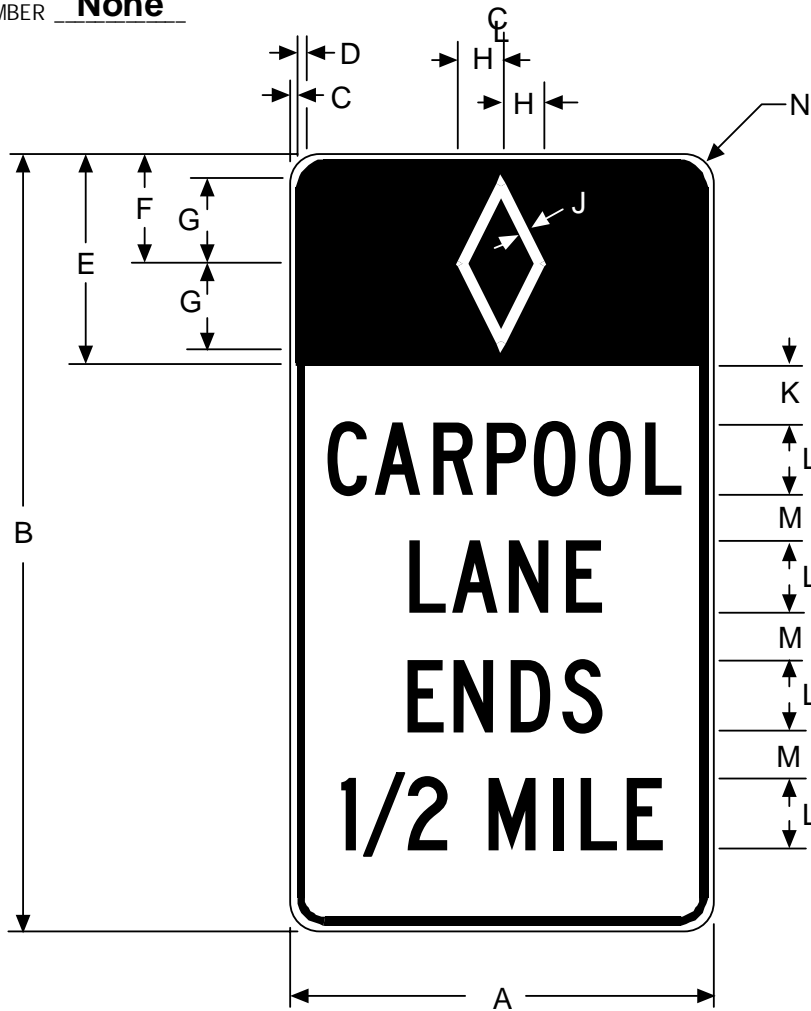
REVISION

REVISION

STATE OF CALIFORNIA - DEPARTMENT OF TRANSPORTATION

MUTCD NUMBER None

CODE R84-2



SIGN SIZE (Inches)	DIMENSIONS (Inches)												
	A	B	C	D	E	F	G	H	J	K	L	M	N
30 x 60	30	60	1/2	3/4	18	9-1/4	7-1/2	3-3/4	1-1/8	5	5C	3-1/2	1-7/8
36 x 66	36	66	5/8	7/8	18	9-5/16	7-1/2	3-3/4	1-1/8	5	6C	4	2-1/4
48 x 84	48	84	3/4	1-1/4	18	9-3/8	7-1/2	3-3/4	1-1/8	7	8C	6	3

SIGN SIZE (mm)	DIMENSIONS (Millimeters)												
	A	B	C	D	E	F	G	H	J	K	L	M	N
762 x 1524	762	1524	13	19	450	235	191	95	29	127	125C	89	48
914 x 1676	914	1676	16	22	450	237	191	95	29	127	150C	102	57
1219 x 2134	1219	2134	19	31	450	238	191	95	29	178	200C	152	76

COLORS
BORDER, LEGEND & DIAMOND BACKGROUND - BLACK (NON-REFLECTIVE)
DIAMOND & BACKGROUND - WHITE (REFLECTIVE)

- THE POLICY FOR INTENDED USAGE OF THIS SIGN IS SHOWN ON REVERSE SIDE -

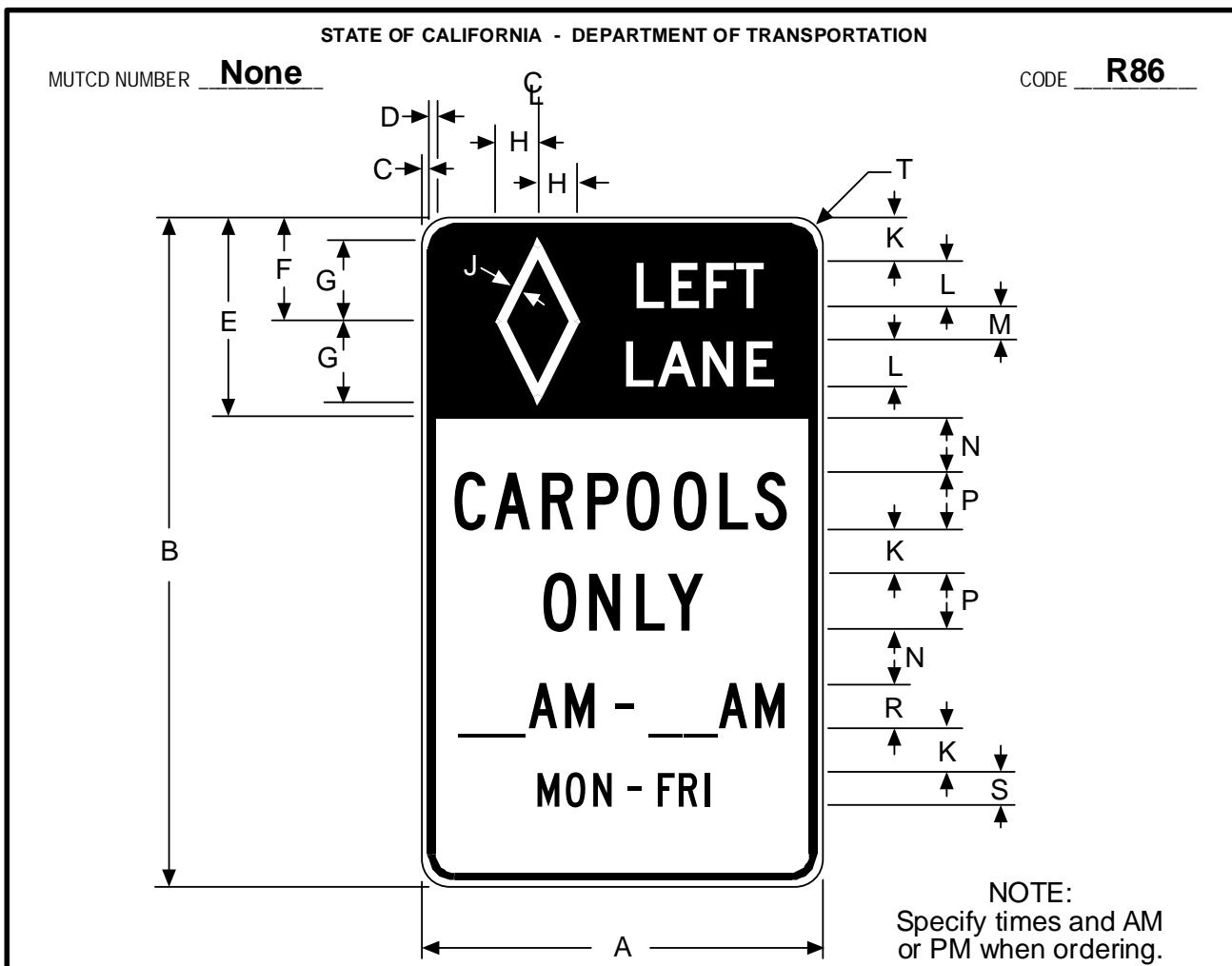
Gary Myers
 CHIEF, OFFICE OF SIGNS AND DELINEATION

8/1/02

DATE

REVISION

REVISION

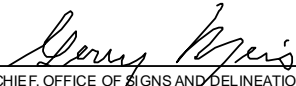


SIGN SIZE (Inches)	DIMENSIONS (Inches)																
	A	B	C	D	E	F	G	H	J	K	L	M	N	P	R	S	T
30 x 60	30	60	1/2	3/4	18	9-1/4	7-1/2	3-3/4	1-1/8	4	4C	3	5	5B	4C	3C	1-7/8
36 x 60	36	60	5/8	7/8	18	9-5/16	7-1/2	3-3/4	1-1/8	4	4D	3	5	5C	4D	3D	2-1/4
48 x 72	48	72	3/4	1-1/4	18	9-3/8	7-1/2	3-3/4	1-1/8	5	4D	3	7	7C	5D	4D	3

SIGN SIZE (mm)	DIMENSIONS (Millimeters)																
	A	B	C	D	E	F	G	H	J	K	L	M	N	P	R	S	T
762 x 1524	762	1524	13	19	450	235	191	95	29	102	100C	76	127	125B	100C	75C	48
914 x 1524	914	1524	16	22	450	237	191	95	29	102	100D	76	127	125C	100D	75D	57
1219 x 1829	1219	1829	19	31	450	238	191	95	29	127	100D	76	178	175C	125D	100D	76

COLORS
BORDER, LEGEND & DIAMOND BACKGROUND - BLACK (NON-REFLECTIVE)
DIAMOND & BACKGROUND - WHITE (REFLECTIVE)

- THE POLICY FOR INTENDED USAGE OF THIS SIGN IS SHOWN ON REVERSE SIDE -

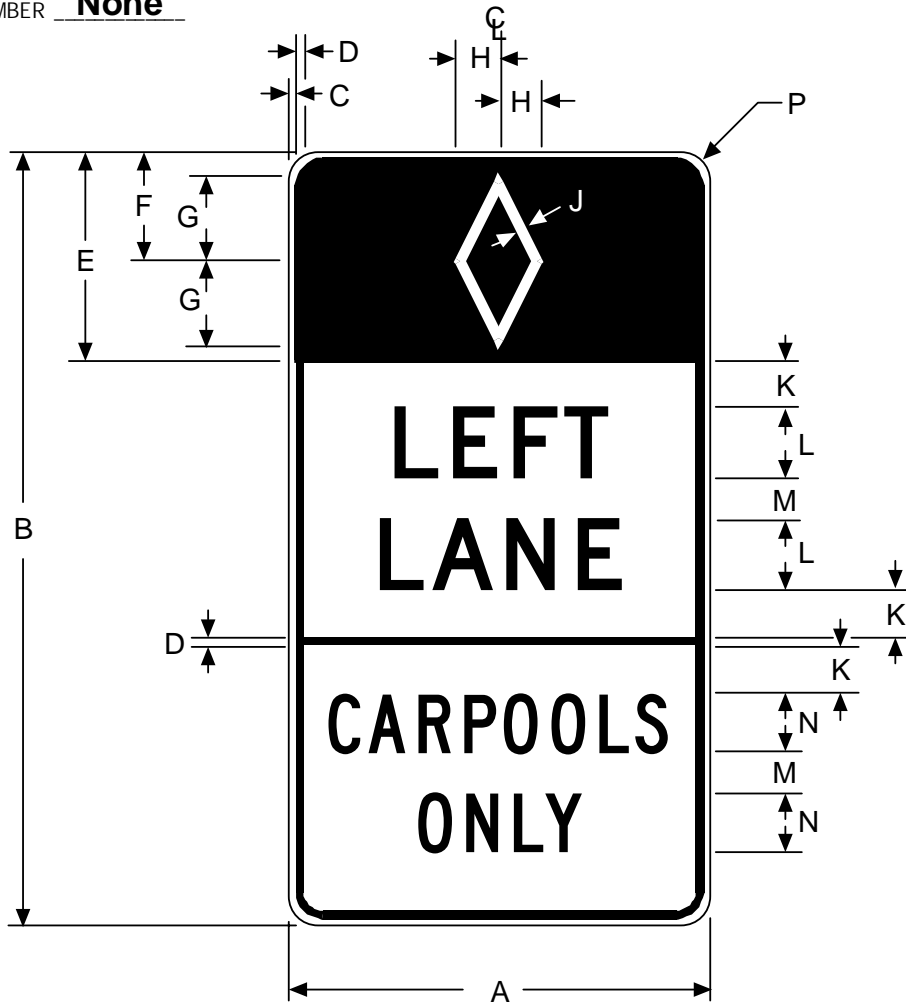

8/1/02
REVISION
REVISION

CHIEF, OFFICE OF SIGNS AND DELINEATION
DATE
REVISION
REVISION

STATE OF CALIFORNIA - DEPARTMENT OF TRANSPORTATION

MUTCD NUMBER None

CODE R86-2



SIGN SIZE (Inches)	DIMENSIONS (Inches)													
	A	B	C	D	E	F	G	H	J	K	L	M	N	P
30 x 60	30	60	1/2	3/4	18	9-1/4	7-1/2	3-3/4	1-1/8	4	5D	3	4C	1-7/8
36 x 66	36	66	5/8	7/8	18	9-5/16	7-1/2	3-3/4	1-1/8	4	6D	3-1/2	5C	2-1/4
48 x 84	48	84	3/4	1-1/4	18	9-3/8	7-1/2	3-3/4	1-1/8	6	8D	5	6C	3

SIGN SIZE (mm)	DIMENSIONS (Millimeters)													
	A	B	C	D	E	F	G	H	J	K	L	M	N	P
762 x 1524	762	1524	13	19	450	235	191	95	29	102	125C	76	100C	48
914 x 1676	914	1676	16	22	450	237	191	95	29	102	150C	89	125C	57
1219 x 2134	1219	2134	19	31	450	238	191	95	29	152	200C	127	150C	76

COLORS
BORDER, LEGEND & DIAMOND BACKGROUND - BLACK (NON-REFLECTIVE)
DIAMOND & BACKGROUND - WHITE (REFLECTIVE)

- THE POLICY FOR INTENDED USAGE OF THIS SIGN IS SHOWN ON REVERSE SIDE -

Gerry Myers
 CHIEF, OFFICE OF SIGNS AND DELINEATION

8/1/02

DATE

REVISION

REVISION

STATE OF CALIFORNIA - DEPARTMENT OF TRANSPORTATION

MUTCD NUMBER None CODE R86-3

NOTE:
Specify times when ordering.

SIGN SIZE (Inches)	DIMENSIONS (Inches)																
	A	B	C	D	E	F	G	H	J	K	L	M	N	P	R	S	T
30 x 66	30	66	1/2	3/4	18	9-1/4	7-1/2	3-3/4	1-1/8	4	4C	3	5	5B	4C	3C	1-7/8
36 x 66	36	66	5/8	7/8	18	9-5/16	7-1/2	3-3/4	1-1/8	4	4D	3	5	5C	4D	3D	2-1/4
48 x 78	48	84	3/4	1-1/4	18	9-3/8	7-1/2	3-3/4	1-1/8	4	4D	3	6	7C	5D	4D	3

SIGN SIZE (mm)	DIMENSIONS (Millimeters)																
	A	B	C	D	E	F	G	H	J	K	L	M	N	P	R	S	T
762 x 1676	762	1676	13	19	450	235	191	95	29	102	100C	76	127	125B	100C	75C	48
914 x 1676	914	1676	16	22	450	237	191	95	29	102	100D	76	127	125C	100D	75D	57
1219 x 2134	1219	2134	19	31	450	238	191	95	29	102	100D	76	152	175C	125D	100D	76

COLORS
BORDER, LEGEND & DIAMOND BACKGROUND - BLACK (NON-REFLECTIVE)
DIAMOND & BACKGROUND - WHITE (REFLECTIVE)
 - THE POLICY FOR INTENDED USAGE OF THIS SIGN IS SHOWN ON REVERSE SIDE -

CHIEF, OFFICE OF SIGNS AND DELINEATION

8/1/02

DATE

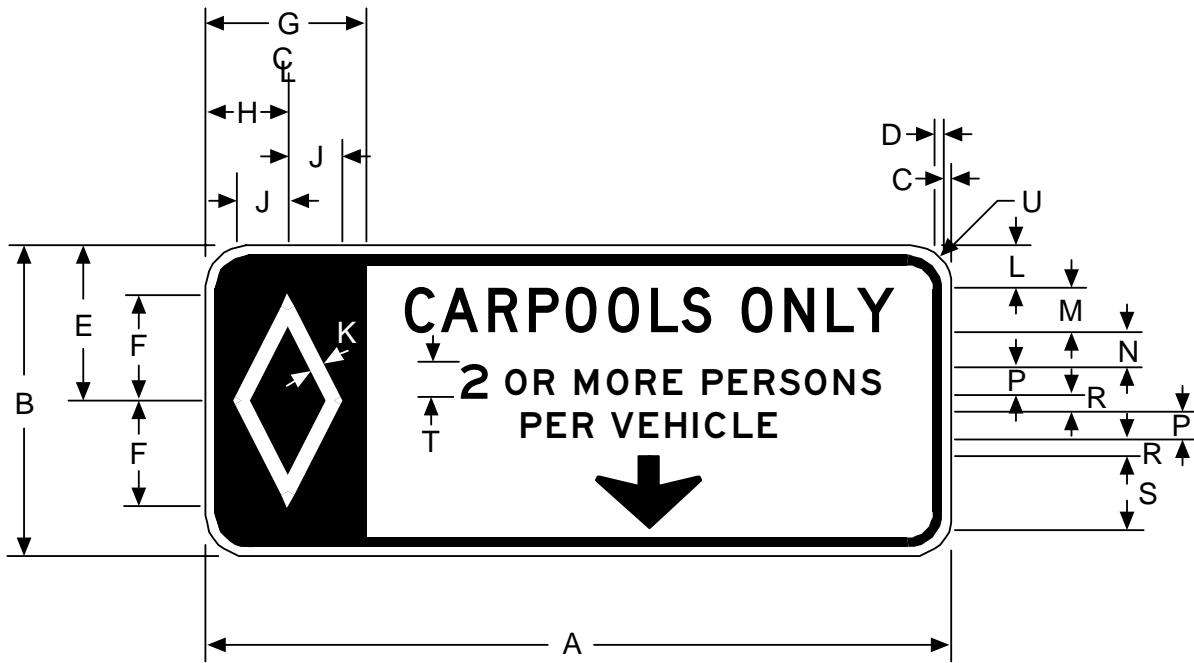
REVISION

REVISION

STATE OF CALIFORNIA - DEPARTMENT OF TRANSPORTATION

MUTCD NUMBER None

CODE R87-1



NOTES:

1. Specify number of persons per vehicle when ordering.
2. For arrow dimensions, see Standard Arrows for Directional Signs in Chapter 5, Appendix 1.

SIGN SIZE (Inches)	DIMENSIONS (Inches)																	
	A	B	C	D	E	F	G	H	J	K	L	M	N	P	R	S	T	U
168 x 70	168	70	1	1-3/4	35	24	36	18-1/2	12	3	9-1/2	10D	8	6E	4	16-1/2	8E	9
192 x 100	192	100	1-1/2	2	50	24	36	18-3/4	12	3	16	12D	12	8E	8	16-1/2	10E	12

SIGN SIZE (mm)	DIMENSIONS (Millimeters)																	
	A	B	C	D	E	F	G	H	J	K	L	M	N	P	R	S	T	U
4267 x 1778	4267	1778	25	44	889	610	914	470	305	76	241	250D	203	150E	102	419	200E	229
4877 x 2540	4877	2540	38	51	1270	610	914	476	305	76	406	300D	305	200E	203	419	250E	305

COLORS
BORDER, LEGEND & DIAMOND BACKGROUND - BLACK (NON-REFLECTIVE)
DIAMOND & BACKGROUND - WHITE (REFLECTIVE)

- THE POLICY FOR INTENDED USAGE OF THIS SIGN IS SHOWN ON REVERSE SIDE -

George Kyeis
 CHIEF, OFFICE OF SIGNS AND DELINEATION

8/1/02
 DATE

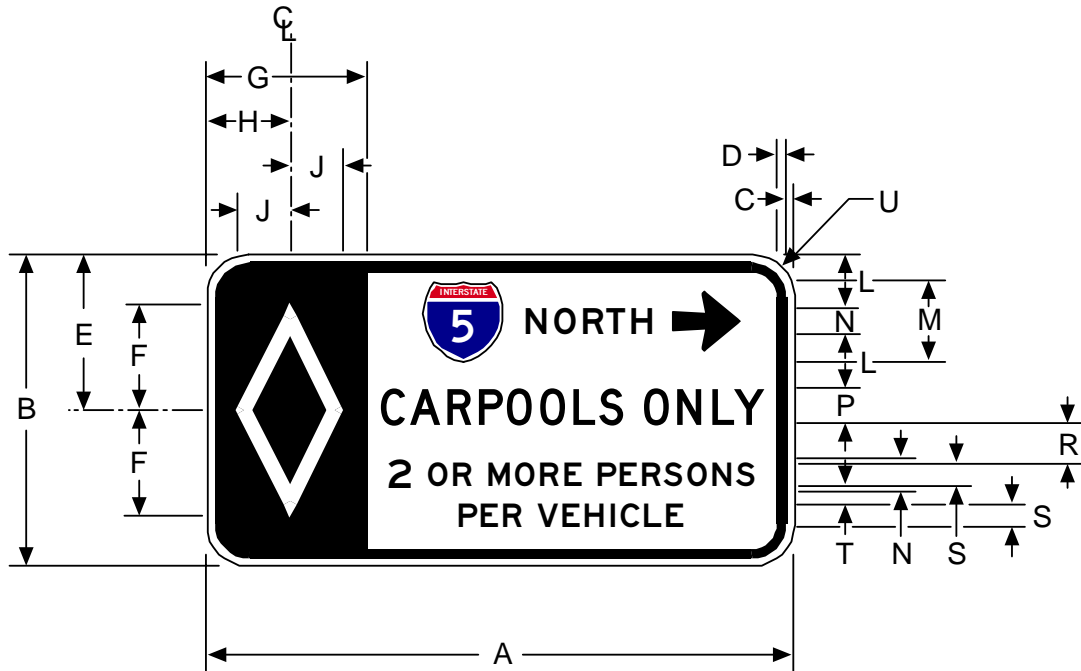
REVISION

REVISION

STATE OF CALIFORNIA - DEPARTMENT OF TRANSPORTATION

MUTCD NUMBER None

CODE R87-2



NOTES:

1. Specify number of persons per vehicle when ordering.
2. For Route Shield details, see Sign Specifications G26-1, G27-1 or G28-1, in Chapter 5, Appendix 1.
3. For arrow size and dimensions, see Standard Arrows for Directional Signs in Chapter 5, Appendix 1.

SIGN SIZE (Inches)	DIMENSIONS (Inches)																	
	A	B	C	D	E	F	G	H	J	K	L	M	N	P	R	S	T	U
132 x 70	132	70	1	1-3/4	35	24	36	18-1/2	12	3	12	18	6E	8D	9	5E	4	9
132 x 72	132	72	1	1-3/4	36	24	36	18-1/2	12	3	13	18	6E	8D	9	5E	4	9

SIGN SIZE (mm)	DIMENSIONS (Millimeters)																	
	A	B	C	D	E	F	G	H	J	K	L	M	N	P	R	S	T	U
3353 x 1778	3353	1778	25	44	889	610	914	470	305	76	305	457	150E	200D	229	125E	102	229
3353 x 1829	3353	1829	25	44	914	610	914	470	305	76	330	457	150E	200D	229	125E	102	229

COLORS

BORDER, LEGEND & DIAMOND BACKGROUND - BLACK (NON-REFLECTIVE)
DIAMOND & BACKGROUND - WHITE (REFLECTIVE)

- THE POLICY FOR INTENDED USAGE OF THIS SIGN IS SHOWN ON REVERSE SIDE -

George Krus
 CHIEF, OFFICE OF SIGNS AND DELINEATION

8/1/02
 DATE

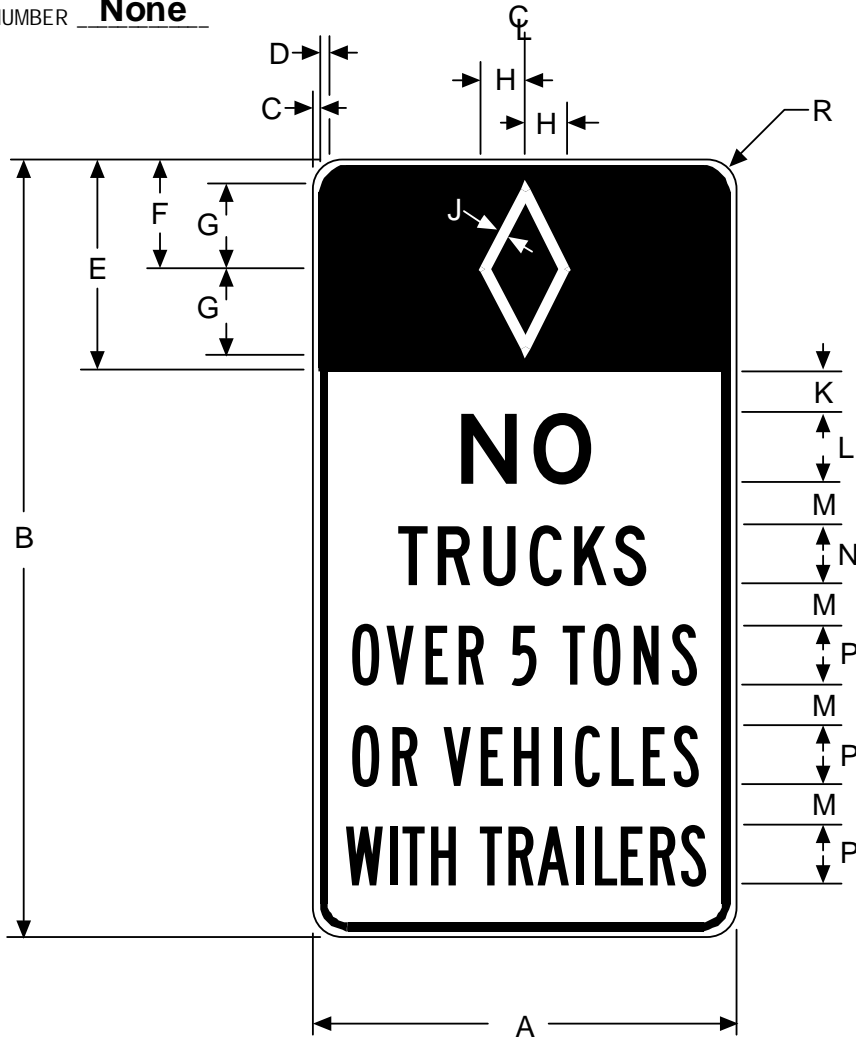
REVISION

REVISION

STATE OF CALIFORNIA - DEPARTMENT OF TRANSPORTATION

MUTCD NUMBER **None**

CODE **R91-2**



SIGN SIZE (Inches)	DIMENSIONS (Inches)														
	A	B	C	D	E	F	G	H	J	K	L	M	N	P	R
36 x 66	36	66	5/8	7/8	18	9-5/16	7-1/2	3-3/4	1-1/8	3-1/2	6E	3-1/2	5C	5B	2-1/4
48 x 78	48	78	3/4	1-1/4	18	9-3/8	7-1/2	3-3/4	1-1/8	5	8E	4	6C	6B	3

SIGN SIZE (mm)	DIMENSIONS (Millimeters)														
	A	B	C	D	E	F	G	H	J	K	L	M	N	P	R
914 x 1676	914	1676	16	22	457	237	191	95	29	89	150E	89	125C	125B	57
1219 x 1981	1219	1981	19	32	457	238	191	95	29	127	200E	102	150C	150B	76

COLORS
BORDER, LEGEND & DIAMOND BACKGROUND - BLACK (NON-REFLECTIVE)
DIAMOND & BACKGROUND - WHITE (REFLECTIVE)

- THE POLICY FOR INTENDED USAGE OF THIS SIGN IS SHOWN ON REVERSE SIDE -

Garry Myers
 CHIEF, OFFICE OF SIGNS AND DELINEATION

8/1/02
 DATE

REVISION

REVISION

STATE OF CALIFORNIA - DEPARTMENT OF TRANSPORTATION

MUTCD NUMBER NONE

CODE R93A



SIGN SIZE (Inches)	DIMENSIONS (Inches)							
	A	B	C	D	E	F	G	H
30 x 12	30	12	3/8	1/2	2-3/4	2-1/2C	1-1/2	1-1/2
36 x 15	36	15	3/8	5/8	3-1/2	3B	2	2-1/4

SIGN SIZE (mm)	DIMENSIONS (Millimeters)							
	A	B	C	D	E	F	G	H
762 x 305	762	305	10	13	70	63C	38	38
914 x 381	914	381	10	16	89	75B	51	57

COLORS
BORDER & LEGEND - BLACK (NON-REFLECTIVE)
BACKGROUND - WHITE (REFLECTIVE)

- THE POLICY FOR INTENDED USAGE OF THIS SIGN IS SHOWN ON REVERSE SIDE -

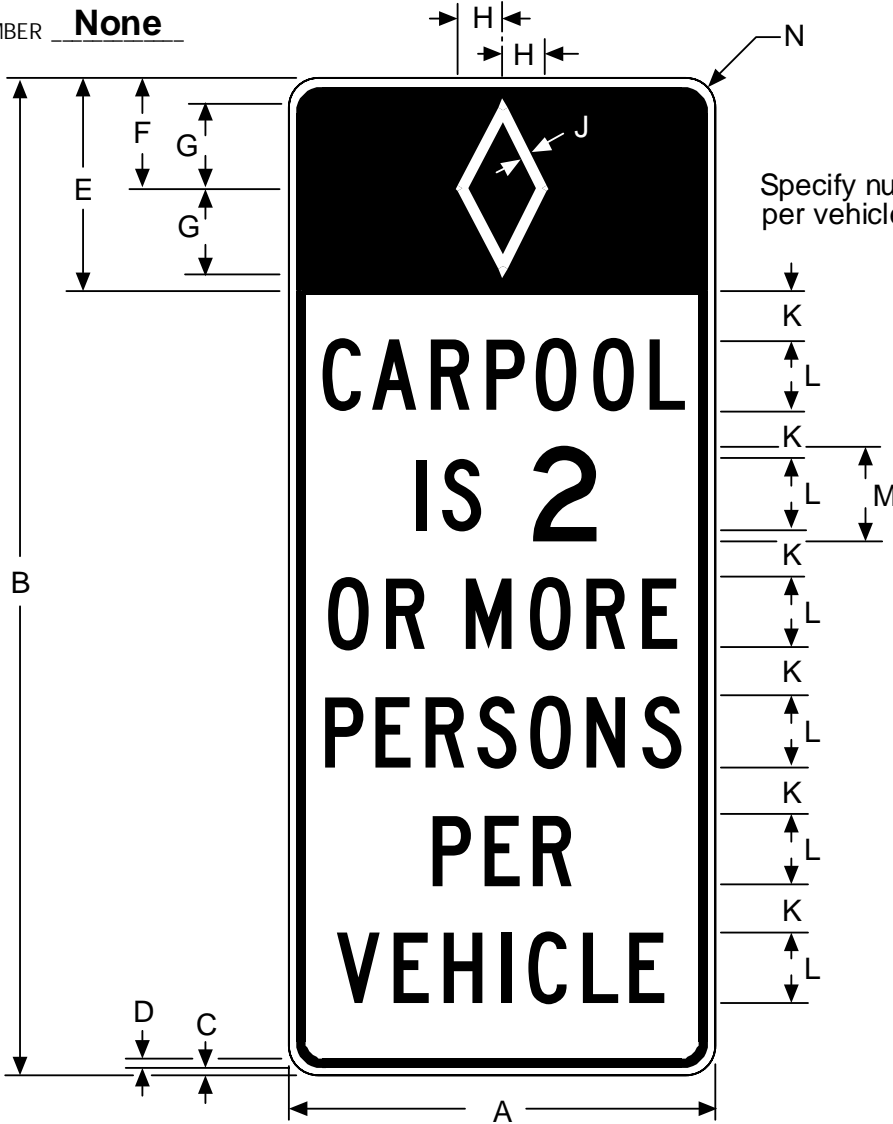
Gerry Meis
 DEPUTY CHIEF, DIVISION OF TRAFFIC OPERATIONS

8/1/02
 DATE

REVISION

REVISION

STATE OF CALIFORNIA - DEPARTMENT OF TRANSPORTATION
 MUTCD NUMBER None CODE R93-2



SIGN SIZE (Inches)	DIMENSIONS (Inches)												
	A	B	C	D	E	F	G	H	J	K	L	M	N
30 x 72	30	72	1/2	3/4	18	9-1/4	7-1/2	3-3/4	1-1/8	3-1/4	5C	6D	1-7/8
36 x 84	36	84	5/8	7/8	18	9-5/16	7-1/2	3-3/4	1-1/8	4	6C	8D	2-1/4

SIGN SIZE (mm)	DIMENSIONS (Millimeters)												
	A	B	C	D	E	F	G	H	J	K	L	M	N
762 x 1829	762	1829	13	19	457	235	191	95	29	83	125C	150D	48
914 x 2134	914	2134	16	22	457	237	191	95	29	102	150C	200D	57

COLORS
BORDER, LEGEND & DIAMOND BACKGROUND - BLACK (NON-REFLECTIVE)
DIAMOND & BACKGROUND - WHITE (REFLECTIVE)

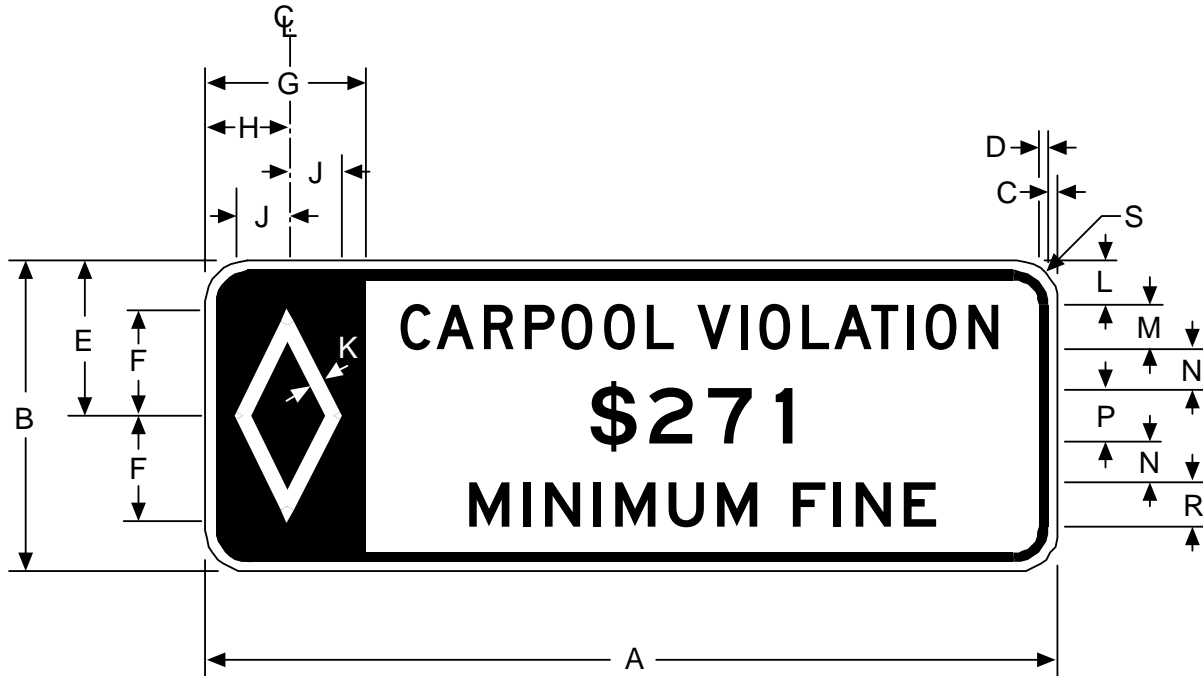
- THE POLICY FOR INTENDED USAGE OF THIS SIGN IS SHOWN ON REVERSE SIDE -

George Myers
 CHIEF, OFFICE OF SIGNS AND DELINEATION
 8/1/02
 DATE
 REVISION
 REVISION

STATE OF CALIFORNIA - DEPARTMENT OF TRANSPORTATION

MUTCD NUMBER None

CODE SR50-1



NOTE: Specify fine amount when ordering.

SIGN SIZE (Inches)	DIMENSIONS (Inches)															
	A	B	C	D	E	F	G	H	J	K	L	M	N	P	R	S
192 x 70	192	70	1	1-3/4	35	24	36	18-1/2	12	3	10	10D	9	12E	10E	9

SIGN SIZE (mm)	DIMENSIONS (Millimeters)															
	A	B	C	D	E	F	G	H	J	K	L	M	N	P	R	S
4877 x 1778	4877	1778	25	44	889	610	914	470	305	76	254	10D	229	300E	250E	229

COLORS
BORDER, LEGEND & DIAMOND BACKGROUND - BLACK (NON-REFLECTIVE)
DIAMOND & BACKGROUND - WHITE (REFLECTIVE)

- THE POLICY FOR INTENDED USAGE OF THIS SIGN IS SHOWN ON REVERSE SIDE -

George Kriz
 CHIEF, OFFICE OF SIGNS AND DELINEATION

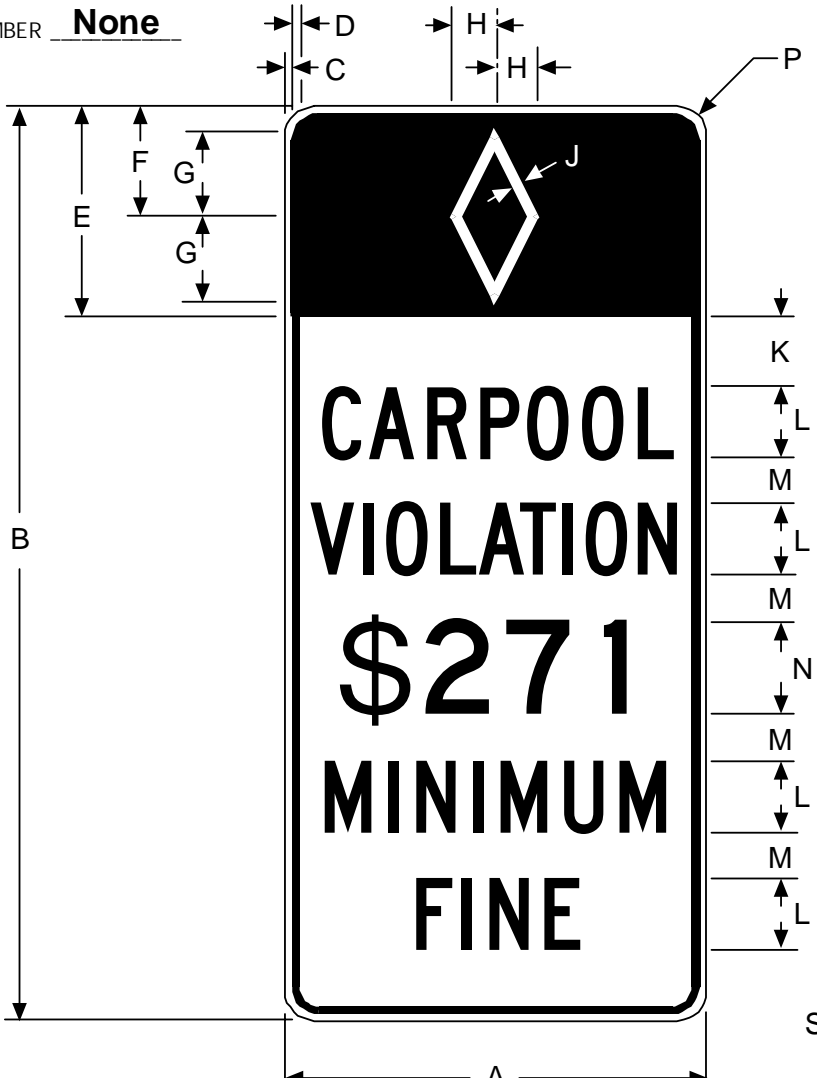
8/1/02
 DATE

REVISION

REVISION

STATE OF CALIFORNIA - DEPARTMENT OF TRANSPORTATION

MUTCD NUMBER None CODE SR50-2

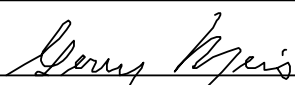


NOTE:
Specify fine amount,
when ordering.

SIGN SIZE (Inches)	DIMENSIONS (Inches)													
	A	B	C	D	E	F	G	H	J	K	L	M	N	P
30 x 66	30	66	1/2	3/4	18	9-1/4	7-1/2	3-3/4	1-1/8	5	5C	3	6D	1-7/8
36 x 78	36	78	5/8	7/8	18	9-5/16	7-1/2	3-3/4	1-1/8	6	6C	4	8D	2-1/4
48 x 96	48	96	3/4	1-1/4	18	9-3/8	7-1/2	3-3/4	1-1/8	7	8C	5-1/2	10D	3

SIGN SIZE (mm)	DIMENSIONS (Millimeters)													
	A	B	C	D	E	F	G	H	J	K	L	M	N	P
762 x 1676	762	1676	13	19	450	235	191	95	29	127	125C	76	150D	48
914 x 1981	914	1981	16	22	450	237	191	95	29	152	150C	102	200D	57
1219 x 2438	1219	2438	19	31	450	238	191	95	29	178	200C	140	250D	76

COLORS
BORDER, LEGEND & DIAMOND BACKGROUND - BLACK (NON-REFLECTIVE)
DIAMOND & BACKGROUND - WHITE (REFLECTIVE)
 - THE POLICY FOR INTENDED USAGE OF THIS SIGN IS SHOWN ON REVERSE SIDE -


 CHIEF, OFFICE OF SIGNS AND DELINEATION

8/1/02
 DATE

REVISION

REVISION

STATE OF CALIFORNIA - DEPARTMENT OF TRANSPORTATION


MUTCD NUMBER None CODE **W11-1**
Lt. or Rt.

SIGN SIZE (Inches)	DIMENSIONS (Inches)																
	A	B	C	D	E	F	G	H	J	K	L	M	N	P	R	S	T
30 x 60	30	60	1/2	3/4	18	9-1/4	7-1/2	3-3/4	1-1/8	7-1/2	9	7-1/2	3	4-1/2	1-1/2	3-1/2	1-7/8
36 x 60	36	60	5/8	7/8	18	9-5/16	7-1/2	3-3/4	1-1/8	7-1/2	9	7-1/2	3	4-1/2	1-1/2	3-1/2	2-1/4
48 x 72	48	72	3/4	1-1/4	18	9-3/8	7-1/2	3-3/4	1-1/8	9	12	10	4	6	2	4-3/4	3

SIGN SIZE (mm)	DIMENSIONS (Millimeters)																
	A	B	C	D	E	F	G	H	J	K	L	M	N	P	R	S	T
762 x 1524	762	1524	13	19	450	235	191	95	29	191	229	191	76	114	38	89	48
914 x 1524	914	1524	16	22	450	237	191	95	29	191	229	191	76	114	38	89	57
1219 x 1829	1219	1829	19	31	450	238	191	95	29	229	305	254	102	152	51	121	76

COLORS
BORDER, LEGEND & DIAMOND BACKGROUND - BLACK (NON-REFLECTIVE)
DIAMOND - WHITE (REFLECTIVE)
BACKGROUND - YELLOW (REFLECTIVE)

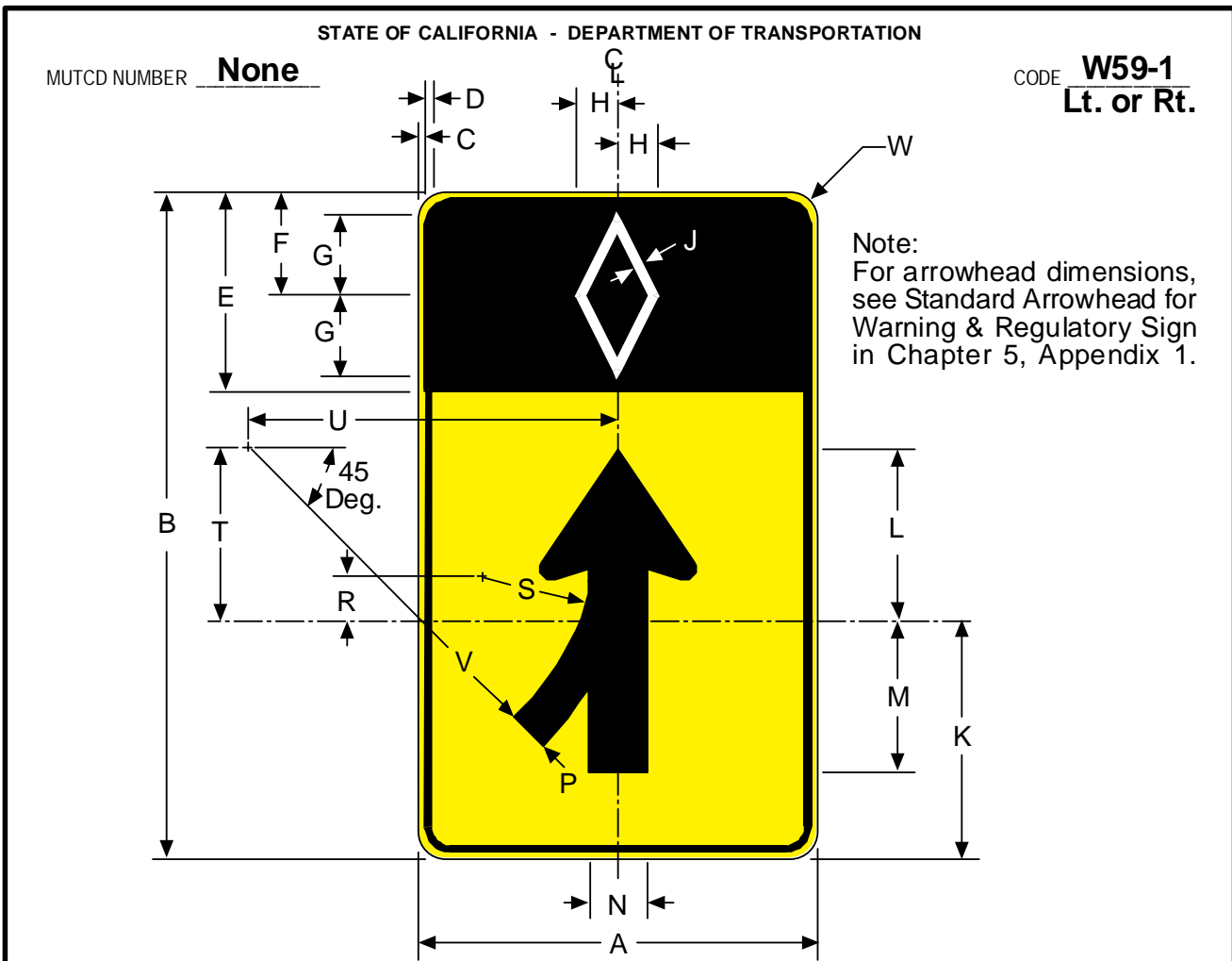
- THE POLICY FOR INTENDED USAGE OF THIS SIGN IS SHOWN ON REVERSE SIDE -


 CHIEF, OFFICE OF SIGNS AND DELINEATION

8/1/02
 DATE

REVISION

REVISION



SIGN SIZE (Inches)	DIMENSIONS (Inches)																			
	A	B	C	D	E	F	G	H	J	K	L	M	N	P	R	S	T	U	V	W
30 x 60	30	60	1/2	3/4	18	9-1/4	7-1/2	3-3/4	1-1/8	21	15-3/4	13-1/4	5-1/4	3-5/8	4	9-5/8	15-5/8	33-5/16	33-5/8	1-7/8
36 x 60	36	60	5/8	7/8	18	9-5/16	7-1/2	3-3/4	1-1/8	21	15-3/4	13-1/4	5-1/4	3-5/8	4	9-5/8	15-5/8	33-5/16	33-5/8	2-1/4
48 x 72	48	72	3/4	1-1/4	18	9-3/8	7-1/2	3-3/4	1-1/8	27	20-1/2	17-1/2	7	4-3/4	5-1/4	12-13/16	20-3/4	44-3/8	45	3

SIGN SIZE (mm)	DIMENSIONS (Millimeters)																			
	A	B	C	D	E	F	G	H	J	K	L	M	N	P	R	S	T	U	V	W
762 x 1524	762	1524	13	19	450	235	191	95	29	533	400	337	133	92	102	244	397	846	854	48
914 x 1524	914	1524	16	22	450	237	191	95	29	533	400	337	133	92	102	244	397	846	854	57
1219 x 1829	1219	1829	19	31	450	238	191	95	29	686	521	445	178	121	133	325	527	1127	1143	76

COLORS
BORDER, LEGEND & DIAMOND BACKGROUND - BLACK (NON-REFLECTIVE)
DIAMOND - WHITE (REFLECTIVE)
BACKGROUND - YELLOW (REFLECTIVE)

- THE POLICY FOR INTENDED USAGE OF THIS SIGN IS SHOWN ON REVERSE SIDE -


 CHIEF, OFFICE OF SIGNS AND DELINEATION 8/1/02 REVISION REVISION
 DATE

STATE OF CALIFORNIA - DEPARTMENT OF TRANSPORTATION

MUTCD NUMBER None CODE W72B

Notes:
Speed Variable,
specify when ordering.

SIGN SIZE (Inches)	DIMENSIONS (Inches)														
	A	B	C	D	E	F	G	H	J	K	L	M	N	P	R
36 x 66	36	66	3/4	1-1/4	18	9-5/16	7-1/2	3-3/4	1-1/8	4	6E	5-1/2	12E	5E	3
48 x 78	48	78	7/8	1-1/2	18	9-3/8	7-1/2	3-3/4	1-1/8	5	8E	6-1/2	16E	6E	3-3/4
60 x 102	60	102	1	1-3/4	27	13-15/16	10	5	1-1/2	6	10E	8	20E	8E	4-1/2

SIGN SIZE (mm)	DIMENSIONS (Millimeters)														
	A	B	C	D	E	F	G	H	J	K	L	M	N	P	R
914 x 1676	914	1676	19	32	457	237	191	95	29	102	150E	140	300E	125E	76
1219 x 1981	1219	1981	22	38	457	238	191	95	29	127	200E	165	400E	150E	95
1524 x 2591	1524	2591	25	44	686	354	254	127	38	152	250E	203	500E	200E	114

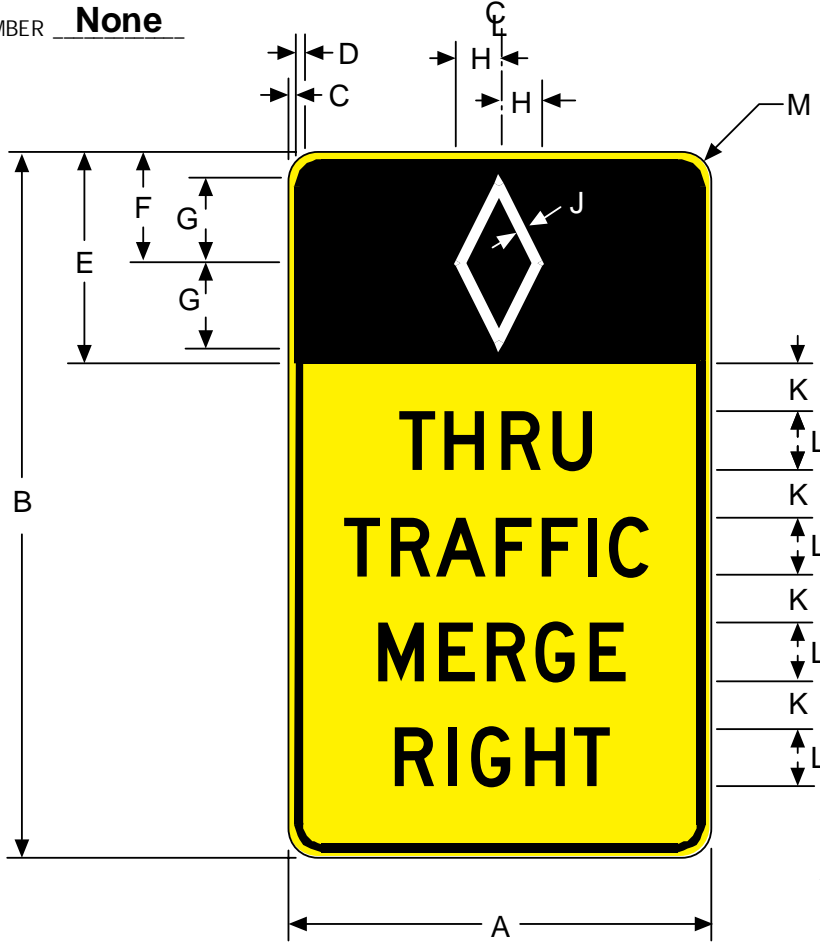
COLORS
BORDER, LEGEND & DIAMOND BACKGROUND - BLACK (NON-REFLECTIVE)
DIAMOND - WHITE (REFLECTIVE)
BACKGROUND - YELLOW (REFLECTIVE)
 - THE POLICY FOR INTENDED USAGE OF THIS SIGN IS SHOWN ON REVERSE SIDE -

Garry Myers
CHIEF, OFFICE OF SIGNS AND DELINEATION
8/1/02
DATE
REVISION
REVISION

STATE OF CALIFORNIA - DEPARTMENT OF TRANSPORTATION

MUTCD NUMBER None

CODE W74-1
Lt. or Rt.



Alternate Message,
Line 4: LEFT.

SIGN SIZE (Inches)	DIMENSIONS (Inches)											
	A	B	C	D	E	F	G	H	J	K	L	M
30 x 60	30	60	1/2	3/4	18	9-1/4	7-1/2	3-3/4	1-1/8	4	5C	1-7/8
36 x 60	36	60	5/8	7/8	18	9-5/16	7-1/2	3-3/4	1-1/8	4	5D	2-1/4
48 x 72	48	72	3/4	1-1/4	18	9-3/8	7-1/2	3-3/4	1-1/8	6	7D	3

SIGN SIZE (mm)	DIMENSIONS (Millimeters)											
	A	B	C	D	E	F	G	H	J	K	L	M
762 x 1524	762	1524	13	19	450	235	191	95	29	102	125C	48
914 x 1524	914	1524	16	22	450	237	191	95	29	102	125D	57
1219 x 1829	1219	1829	19	31	450	238	191	95	29	152	175D	76

COLORS
BORDER, LEGEND & DIAMOND BACKGROUND - BLACK (NON-REFLECTIVE)
DIAMOND - WHITE (REFLECTIVE)
BACKGROUND - YELLOW (REFLECTIVE)

- THE POLICY FOR INTENDED USAGE OF THIS SIGN IS SHOWN ON REVERSE SIDE -

Gerry Myers
CHIEF, OFFICE OF SIGNS AND DELINEATION

8/1/02
DATE

REVISION

REVISION

STATE OF CALIFORNIA - DEPARTMENT OF TRANSPORTATION

MUTCD NUMBER None CODE W75-1
Lt. or Rt.

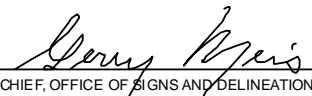
Alternate Message,
Line 4: LEFT.

SIGN SIZE (Inches)	DIMENSIONS (Inches)											
	A	B	C	D	E	F	G	H	J	K	L	M
30 x 60	30	60	1/2	3/4	18	9-1/4	7-1/2	3-3/4	1-1/8	4	5C	1-7/8
36 x 60	36	60	5/8	7/8	18	9-5/16	7-1/2	3-3/4	1-1/8	4	5D	2-1/4
48 x 72	48	72	3/4	1-1/4	18	9-3/8	7-1/2	3-3/4	1-1/8	6	7D	3

SIGN SIZE (mm)	DIMENSIONS (Millimeters)											
	A	B	C	D	E	F	G	H	J	K	L	M
762 x 1524	762	1524	13	19	450	235	191	95	29	102	125C	48
914 x 1524	914	1524	16	22	450	237	191	95	29	102	125D	57
1219 x 1829	1219	1829	19	31	450	238	191	95	29	152	175D	76

COLORS
BORDER, LEGEND & DIAMOND BACKGROUND - BLACK (NON-REFLECTIVE)
DIAMOND - WHITE (REFLECTIVE)
BACKGROUND - YELLOW (REFLECTIVE)

- THE POLICY FOR INTENDED USAGE OF THIS SIGN IS SHOWN ON REVERSE SIDE -

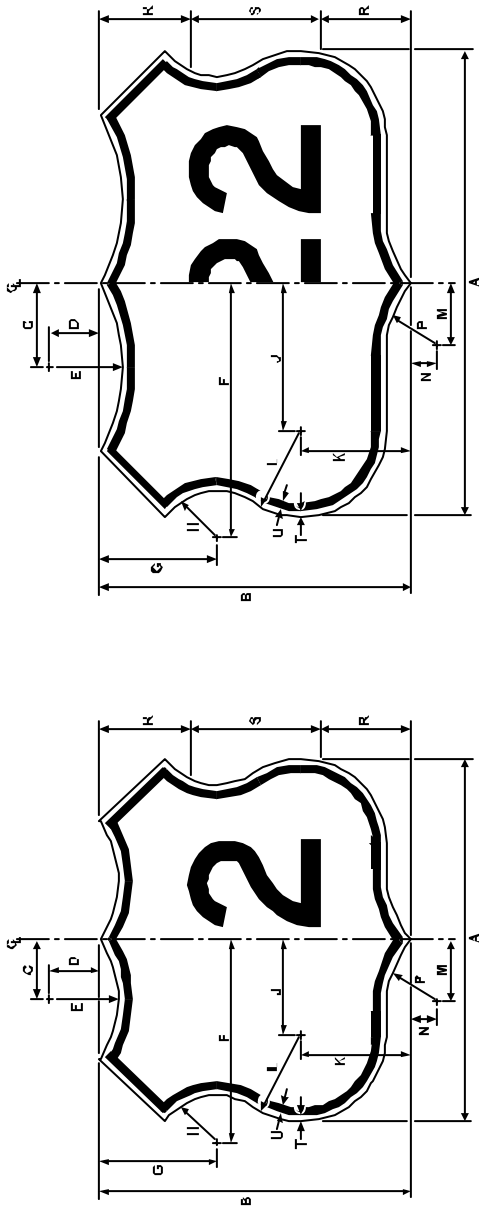

 CHIEF, OFFICE OF SIGNS AND DELINEATION

8/1/02
 DATE

REVISION

REVISION

MUTCD NUMBER **M1-4** STATE OF CALIFORNIA - DEPARTMENT OF TRANSPORTATION **G26-1**
U.S. SHIELDS ON GUIDE SIGNS CODE **(Metric)**



COLORS :
 BACKGROUND - WHITE (REFLECTIVE)
 BORDER & LEGEND - BLACK
 (NON-REFLECTIVE)

DIMENSIONS (MILLIMETERS)

	100mm Numerals		200mm Numerals		250mm Numerals		300mm Numerals		375mm Numerals		450mm Numerals	
	2 Digits	3 Digits	2 Digits	3 Digits	2 Digits	3 Digits	2 Digits	3 Digits	2 Digits	3 Digits	2 Digits	3 Digits
A	295	381	533	686	711	914	839	1143	1067	1372	1245	1600
B	254	254	457	457	610	610	762	762	914	914	1067	1067
C	48	70	87	125	116	167	144	208	173	249	202	291
D	70	149	125	270	167	360	208	449	249	540	291	629
E	84	141	152	298	203	398	254	498	305	598	356	699
F	183	225	321	397	429	530	535	662	641	794	749	927
G	95	95	171	171	229	229	286	286	343	343	400	400
H	52	52	94	94	124	124	156	156	187	187	217	217
J	79	122	141	217	189	291	237	364	284	437	332	510
K	89	89	160	160	214	214	268	268	322	322	376	376
L	70	70	125	125	167	167	208	208	249	249	291	291
M	59	59	105	105	140	140	175	175	210	210	244	244
N	73	73	132	132	175	175	219	219	264	264	306	306
P	94	94	168	168	224	224	279	279	335	335	391	391
R	76	76	127	127	178	178	229	229	267	267	305	305
S	100	100D	200D	200D	250D	250D	300D	300D	375D	375D	450D	450D
T	8	8	13	13	14	14	19	19	22	22	25	25
U	10	10	14	14	19	19	22	22	25	25	32	32

- THE POLICY FOR INTENDED USAGE OF THIS SIGN IS SHOWN ON REVERSE SIDE -

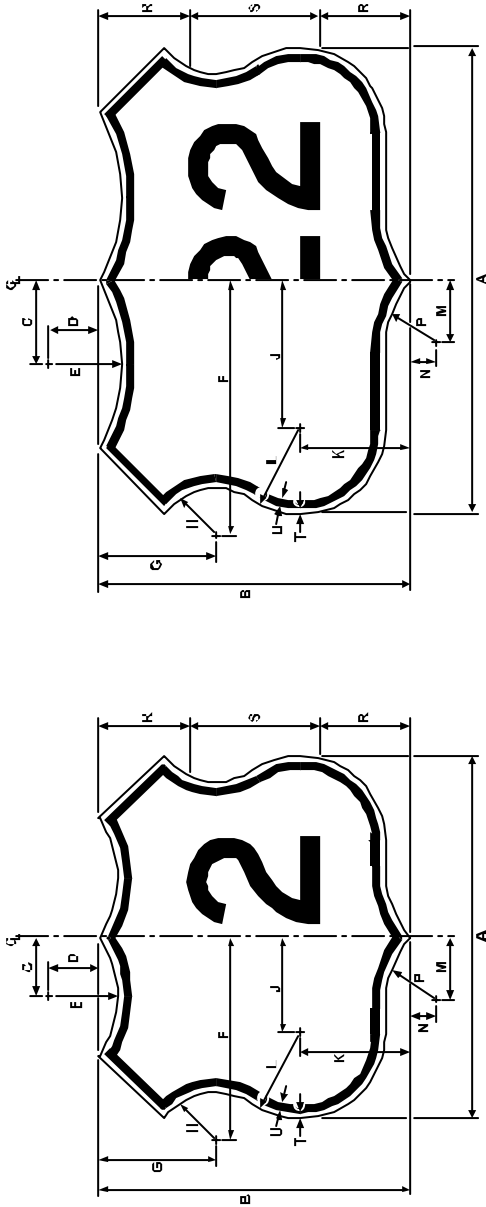
Gerry Myers 8/1/02
 CHIEF, OFFICE OF SIGNS AND DELINEATION DATE REVISION REVISION

STATE OF CALIFORNIA - DEPARTMENT OF TRANSPORTATION

MUTCD NUMBER **M1-4**

U.S. SHIELDS ON GUIDE SIGNS

CODE **G26-1**
(English)



COLORS :
BACKGROUND - WHITE (REFLECTIVE)
BORDER & LEGEND - BLACK
(NON-REFLECTIVE)

DIMENSIONS (INCHES)

	4" Numerals		8" Numerals		10" Numerals		12" Numerals		15" Numerals		18" Numerals	
	2 Digits	3 Digits	2 Digits	3 Digits	2 Digits	3 Digits	2 Digits	3 Digits	2 Digits	3 Digits	2 Digits	3 Digits
A	11-5/8	15	21	27	28	36	35	45	42	54	49	63
B	10	10	18	18	24	24	30	30	36	36	42	42
C	1-7/8	2-3/4	3-7/16	4-15/16	4-9/16	6-9/16	5-11/16	8-3/16	6-13/16	9-13/16	7-15/16	11-7/16
D	2-3/4	5-7/8	4-15/16	10-5/8	6-9/16	14-3/16	8-3/16	17-11/16	9-13/16	21-1/4	11-7/16	24-3/4
E	3-5/16	5-9/16	6	11-3/4	8	15-11/16	10	19-5/8	12	23-9/16	14	27-1/2
F	7-3/16	8-7/8	12-5/8	15-5/8	16-7/8	20-7/8	21-1/16	26-1/16	25-1/4	31-1/4	29-1/2	36-1/2
G	3-3/4	3-3/4	6-3/4	6-3/4	9	9	11-1/4	11-1/4	13-1/2	13-1/2	15-3/4	15-3/4
H	2-1/16	2-1/16	3-11/16	3-11/16	4-7/8	4-7/8	6-1/8	6-1/8	7-3/8	7-3/8	8-9/16	8-9/16
J	3-1/8	4-13/16	5-9/16	8-9/16	7-7/16	11-7/16	9-5/16	14-5/16	11-3/16	17-3/16	13-1/16	20-1/16
K	3-1/2	3-1/2	6-5/16	6-5/16	8-7/16	8-7/16	10-9/16	10-9/16	12-11/16	12-11/16	14-13/16	14-13/16
L	2-3/4	2-3/4	4-15/16	4-15/16	6-9/16	6-9/16	8-3/16	8-3/16	9-13/16	9-13/16	11-7/16	11-7/16
M	2-5/16	2-5/16	4-1/8	4-1/8	5-1/2	5-1/2	6-7/8	6-7/8	8-1/4	8-1/4	9-5/8	9-5/8
N	2-7/8	2-7/8	5-3/16	5-3/16	6-7/8	6-7/8	8-5/8	8-5/8	10-3/8	10-3/8	15-5/16	15-5/16
P	3-11/16	3-11/16	6-5/8	6-5/8	8-13/16	8-13/16	11	11	13-3/16	13-3/16	15-3/8	15-3/8
R	3	3	5	5	7	7	9	9	10-1/2	10-1/2	12	12
S	4D	4D	8D	8D	10D	10D	12D	12D	15D	15D	18D	18D
T	5/16	5/16	1/2	1/2	9/16	9/16	3/4	3/4	7/8	7/8	1	1
U	3/8	3/8	9/16	9/16	3/4	3/4	7/8	7/8	1	1	1-1/4	1-1/4

- THE POLICY FOR INTENDED USAGE OF THIS SIGN IS SHOWN ON REVERSE SIDE -

Gerry Kreis
CHIEF, OFFICE OF SIGNS AND DELINEATION

8/1/02

DATE

REVISION

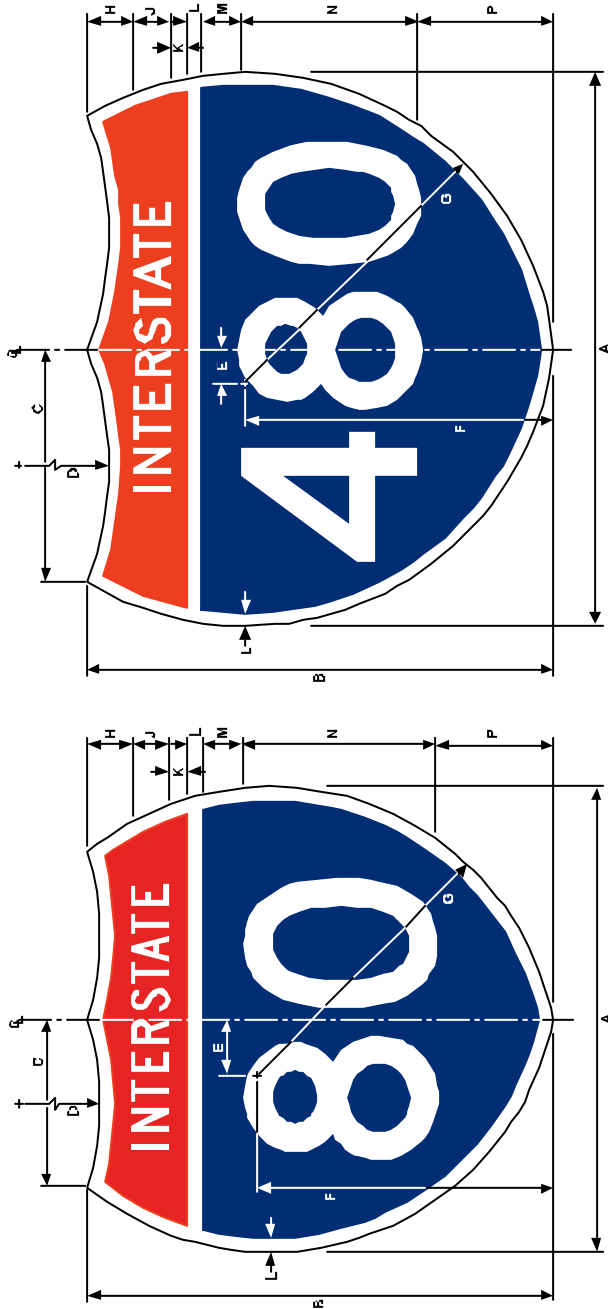
REVISION

MUTCD NUMBER **M1-1**

STATE OF CALIFORNIA - DEPARTMENT OF TRANSPORTATION

**INTERSTATE SHIELDS
USED ON GUIDE SIGNS**

CODE **G27-1
(Metric)**



COLORS :
 BORDER & LEGEND - WHITE (REFLECTIVE)
 INTERSTATE BACKGROUND - RED (REFLECTIVE)
 NUMERAL BACKGROUND - BLUE (REFLECTIVE)

- THE POLICY FOR INTENDED USAGE OF THIS SIGN IS SHOWN ON REVERSE SIDE -

DIMENSIONS (MILLIMETERS)															
100mm Numerals		150mm Num's		200mm Num's		250mm Numerals		300mm Num's		375mm Numerals		450mm Numerals			
2 Digits	3 Digits	3 Digits	2 Digits	2 Digits	3 Digits	3 Digits	2 Digits	2 Digits	3 Digits	3 Digits	2 Digits	2 Digits	3 Digits		
A	356	406	5	533	610	762	914	914	914	914	914	914	1143	1219	1473
B	305	356	457	457	610	635	914	914	914	914	914	914	965	1219	1295
C	152	164	233	233	219	324	329	329	329	329	330	483	483	438	594
D	206	181	333	333	381	445	572	572	572	572	572	667	667	762	864
E	32	25	52	52	73	44	110	110	110	110	110	70	70	146	102
F	208	227	316	316	371	424	557	557	557	557	557	638	638	743	832
G	210	229	319	316	378	425	567	567	567	567	567	641	641	756	838
H	35	35	48	48	59	67	87	87	87	87	87	97	97	121	133
J	25D	25D	47C	47C	50D	50D	75C	75C	75C	75C	75C	125C	125C	125C	125D
K	13	13	16	16	22	21	33	33	33	33	33	51	51	51	44
L	13	13	14	14	19	19	29	29	29	29	29	38	38	38	38
M	30	44	121	25	65	65	79	79	79	79	79	102	102	102	102
N	100D	100D	150D	200D	250D	250D	300D	300D	300D	300D	375D	450D	450D	450D	450D
P	87	124	110	103	140	159	305	305	305	305	229	324	324	324	394

Gerry Kneis
 CHIEF, OFFICE OF SIGNS AND DELINEATION

8/1/02

DATE

REVISION

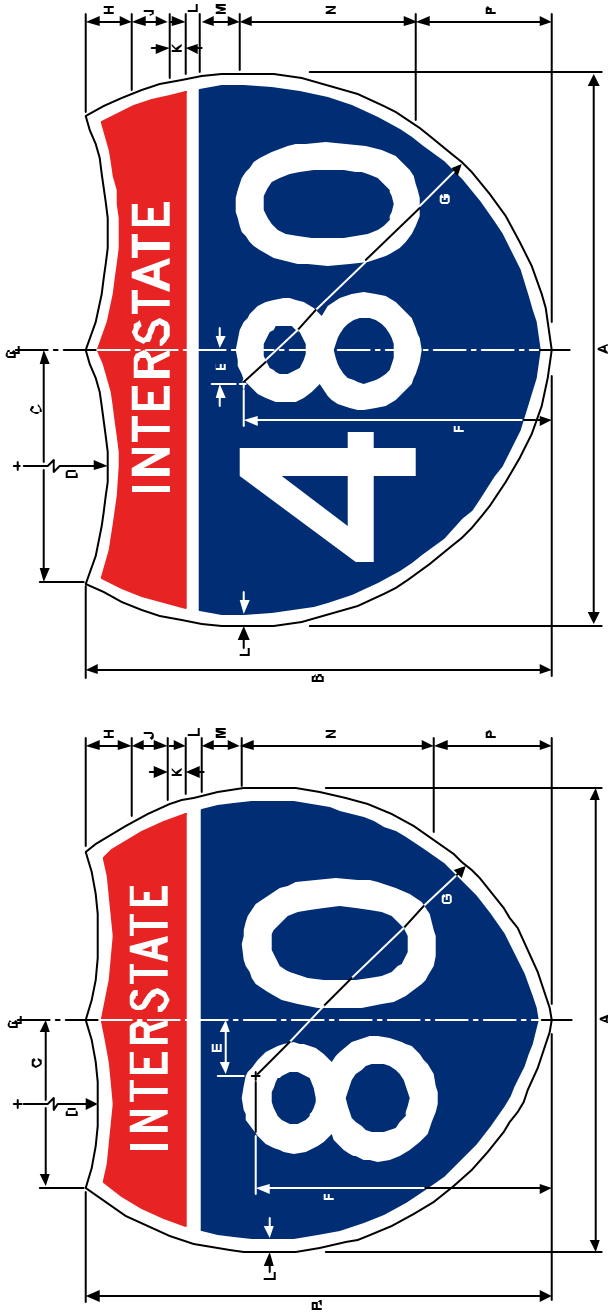
REVISION

MUTCD NUMBER **M1-1**

STATE OF CALIFORNIA - DEPARTMENT OF TRANSPORTATION

**INTERSTATE SHIELDS
USED ON GUIDE SIGNS**

G27-1
CODE (English)



COLORS :
 BORDER & LEGEND - WHITE (REFLECTIVE)
 INTERSTATE BACKGROUND - RED (REFLECTIVE)
 NUMERAL BACKGROUND - BLUE (REFLECTIVE)

- THE POLICY FOR INTENDED USAGE OF THIS SIGN IS SHOWN ON REVERSE SIDE -

DIMENSIONS (INCHES)													
4" Numerals		6" Num's		8" Num's		10" Numerals		12" Num's		15" Numerals		18" Numerals	
2 Digits	3 Digits	3 Digits	2 Digits	2 Digits	2 Digits	2 Digits	2 Digits	3 Digits	3 Digits	2 Digits	3 Digits	2 Digits	3 Digits
A	14	16	21	21	24	24	25	30	36	36	36	48	58
B	12	14	18	18	24	24	25	30	36	36	36	48	51
C	6	6-7/16	9-3/16	9-3/16	8-5/8	8-5/8	12-3/4	12-3/4	12-15/16	12-15/16	12-15/16	17-1/4	23-3/8
D	8-1/8	7-1/8	13-1/8	13-1/8	15	15	17-1/2	17-1/2	22-1/2	22-1/2	26-1/4	30	34
E	1-1/4	1	2-1/16	2-1/16	2-7/8	2-7/8	1-3/4	1-3/4	4-5/16	4-5/16	2-3/4	5-3/4	4
F	8-3/16	8-15/16	12-7/16	12-7/16	14-5/8	14-5/8	16-11/16	16-11/16	21-15/16	21-15/16	25-1/8	29-1/4	32-3/4
G	8-1/4	9	12-9/16	12-9/16	14-7/8	14-7/8	16-3/4	16-3/4	22-5/16	22-5/16	25-1/4	29-3/4	33
H	1-3/8	1-3/8	1-7/8	1-7/8	2-5/16	2-5/16	2-5/8	2-5/8	3-7/16	3-7/16	3-13/16	4-3/4	5-1/4
J	1D	1D	1-7/8C	1-7/8C	2D	2D	2D	2D	3C	3C	3D	5C	5D
K	1/2	1/2	5/8	5/8	7/8	7/8	13/16	13/16	1-5/16	1-5/16	1-5/16	2	1-3/4
L	1/2	1/2	9/16	9/16	3/4	3/4	3/4	3/4	1-1/8	1-1/8	1-1/8	1-1/2	1-1/2
M	1-3/16	1-3/4	4-3/4	4-3/4	1	1	2-9/16	2-9/16	3-1/8	3-1/8	3-1/8	4	4
N	4D	4D	6D	6D	10D	10D	10D	10D	12D	12D	15D	18D	18D
P	3-7/16	4-7/8	4-5/16	4-1/16	5-1/2	5-1/2	6-1/4	6-1/4	12	9	10-5/8	12-3/4	15-1/2

Gerry Myers
 CHIEF, OFFICE OF SIGNS AND DELINEATION

8/1/02

DATE

REVISION

REVISION

STATE OF CALIFORNIA - DEPARTMENT OF TRANSPORTATION

MUTCD NUMBER **M1-5** CODE **G28-1** (Metric)

STATE ROUTE SHIELDS USED ON GUIDE SIGNS

COLORS :
BORDER & LEGEND - WHITE (REFLECTIVE)
BACKGROUND - GREEN (REFLECTIVE)

- THE POLICY FOR INTENDED USAGE OF THIS SIGN IS SHOWN ON REVERSE SIDE -

DIMENSIONS (MILLIMETERS)												
	100mm Numerals		200mm Numerals		250mm Numerals		300mm Numerals		375mm Numerals		450mm Numerals	
	2 Digits	3 Digits	2 Digits	3 Digits	2 Digits	3 Digits	2 Digits	3 Digits	2 Digits	3 Digits	2 Digits	3 Digits
A	267	381	533	610	711	813	889	1016	914	1143	1067	1372
B	2	2	457	457	635	635	813	813	914	914	1067	1067
C	83	121	165	165	254	254	330	330	343	343	394	394
D	100D	100D	200D	200D	250D	250D	300D	300D	357D	375D	450D	450D
E	44	57	89	89	127	127	178	178	191	191	216	216
F	30	25	65	27	87	37	90	27	127	64	148	76
G	68	64	132	127	200	194	286	278	344	283	403	308
H	164	216	332	332	443	443	535	535	584	635	681	762
J	78	133	156	194	208	259	300	364	305	419	357	505
K	65	79	130	138	173	186	181	200	184	213	213	254
L	56	57	111	111	148	148	144	144	152	152	176	181
M	375	457	749	824	1041	1041	1357	1357	1651	1651	1916	1916
N	13	13	19	19	25	25	38	38	44	44	51	51

8/1/02
REVISION
REVISION

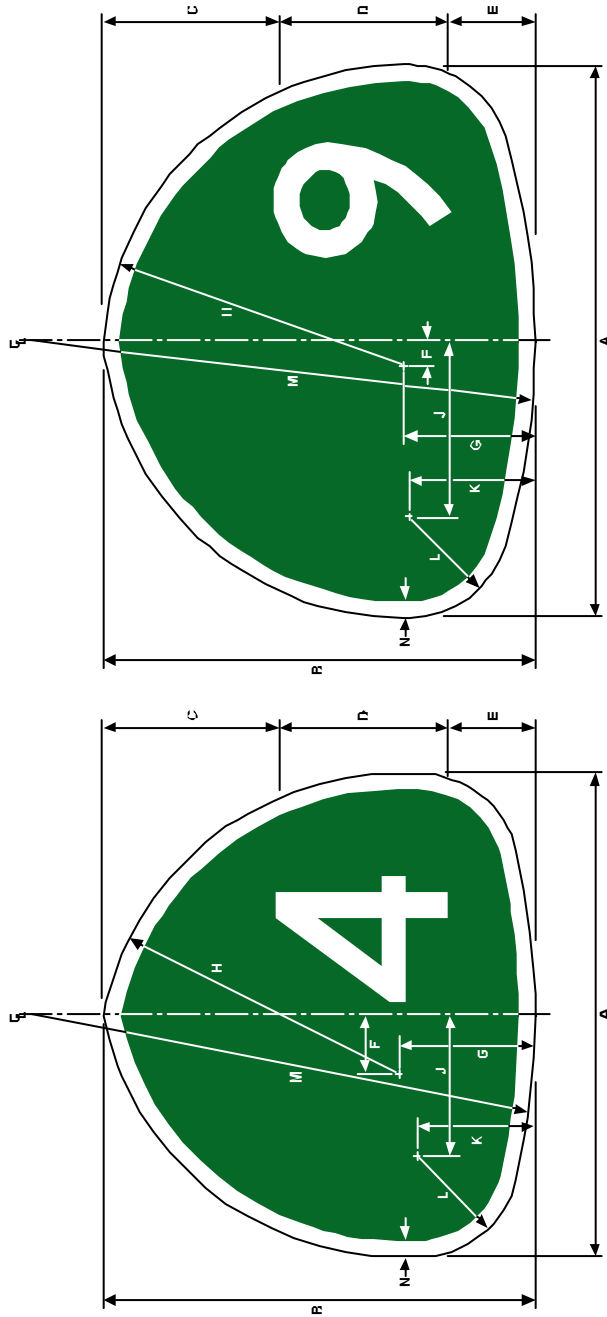
CHIEF, OFFICE OF SIGNS AND DELINEATION
DATE
REVISION
REVISION

STATE OF CALIFORNIA - DEPARTMENT OF TRANSPORTATION

MUTCD NUMBER **M1-5**

**STATE ROUTE SHIELDS
USED ON GUIDE SIGNS**

G28-1
CODE (English)



COLORS :
BORDER & LEGEND - WHITE (REFLECTIVE)
BACKGROUND - GREEN (REFLECTIVE)

DIMENSIONS (INCHES)

	4" Numerals		8" Numerals		10" Numerals		12" Numerals		15" Numerals		18" Numerals	
	2 Digits	3 Digits	2 Digits	3 Digits	2 Digits	3 Digits	2 Digits	3 Digits	2 Digits	3 Digits	2 Digits	3 Digits
A	10-1/2	15	21	24	28	32	35	40	36	45	42	54
B	9	11	18	18	25	25	32	32	36	36	42	42
C	3-1/4	4-3/4	6-1/2	8-1/2	10	10	13	13	13-1/2	13-1/2	15-1/2	15-1/2
D	4D	4D	8D	8D	10D	10D	12D	12D	15D	15D	18D	18D
E	1-3/4	2-1/4	3-1/2	3-1/2	5	5	7	7	7-1/2	7-1/2	8-1/2	8-1/2
F	1-3/16	1	2-9/16	1-1/16	3-7/16	1-7/16	3-9/16	1-1/16	5	2-1/2	5-13/16	3
G	2-11/16	2-1/2	5-3/16	5	7-7/8	7-5/8	11-1/4	10-15/16	13-9/16	11-1/8	15-7/8	12-1/8
H	6-7/16	8-1/2	13-1/16	13-1/16	17-7/16	17-7/16	21-1/16	21-1/16	23	25	26-13/16	30
J	3-1/16	5-1/4	6-1/8	7-5/8	8-3/16	10-3/16	11-13/16	14-5/16	12	16-1/2	14-1/16	19-7/8
K	2-9/16	3-1/8	5-1/8	5-7/16	6-13/16	7-5/16	7-1/8	7-7/8	7-1/4	8-3/8	8-3/8	10
L	2-3/16	2-1/4	4-3/8	4-3/8	5-13/16	5-13/16	5-11/16	5-11/16	6	6	6-15/16	7-1/8
M	14-3/4	18	29-1/2	32-7/16	41	41	53-7/16	53-7/16	65	65	75-7/16	75-7/16
N	1/2	1/2	3/4	3/4	1	1	1-1/2	1-1/2	1-3/4	1-3/4	2	2

- THE POLICY FOR INTENDED USAGE OF THIS SIGN IS SHOWN ON REVERSE SIDE -

Gerry Klein
CHIEF, OFFICE OF SIGNS AND DELINEATION

8/1/02

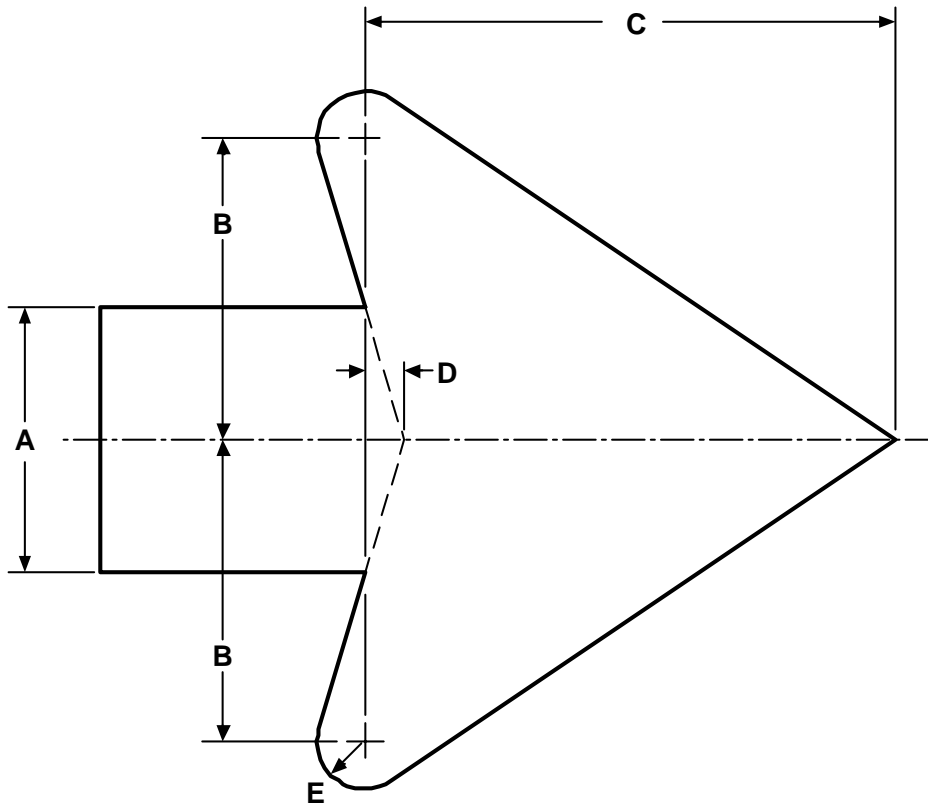
DATE

REVISION

REVISION

STATE OF CALIFORNIA - DEPARTMENT OF TRANSPORTATION

**Standard Arrowhead for
Warning & Regulatory Signs**



Arrowhead Dimensions

- A = Width of Shaft**
- B = 1.14A**
- C = 2.01A**
- D = 0.15A**
- E = 0.18A**

Gerry Kreis
CHIEF, OFFICE OF SIGNS AND DELINEATION

8/1/02

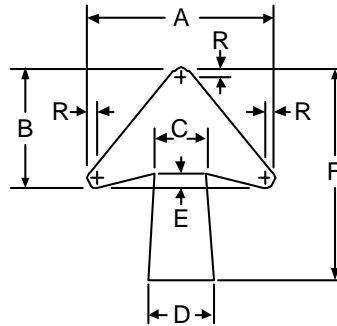
DATE

REVISION

REVISION

STATE OF CALIFORNIA - DEPARTMENT OF TRANSPORTATION

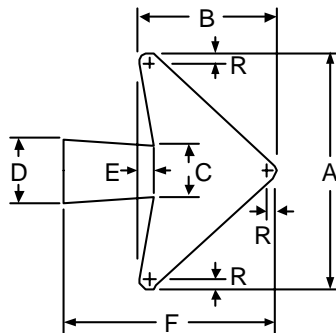
Standard Arrows for Directional Signs



**One Line
Horizontal, Vertical
or Diagonal Arrow**

Letter Sizes	Dimensions in Inches						
	A	B	C	D	E	F	R
4U.C., 4Cap	5-5/8	3-5/8	1-9/16	1-15/16	7/16	6-3/8	5/16
5Cap	7-1/16	4-9/16	1-15/16	2-7/16	9/16	8-1/16	3/8
6U.C.	8-7/16	5-7/16	2-5/16	2-15/16	5/8	9-9/16	1/2
6Cap	11-1/4	7-1/4	3-1/8	3-7/8	7/8	12-3/4	5/8
8U.C.	11-1/4	7-1/4	3-1/8	3-7/8	7/8	12-3/4	5/8
8Cap	14-1/4	9-13/16	3-3/8	4-1/2	1-5/16	17-1/4	3/4
10.67U.C.	14-1/4	9-13/16	3-3/8	4-1/2	1-5/16	17-1/4	3/4
10Cap	17-1/2	11-3/4	4-3/8	5-5/8	1-1/2	20-1/4	7/8
12Cap	17-1/2	11-3/4	4-3/8	5-5/8	1-1/2	20-1/4	7/8
13.3U.C.	17-1/2	11-3/4	4-3/8	5-5/8	1-1/2	20-1/4	7/8
16U.C.	21-7/8	14-1/4	5	6-3/4	1-3/4	25	1

Letter Sizes	Dimensions in Millimeters						
	A	B	C	D	E	F	R
100U.C., 100Cap	143	92	40	49	11	162	8
125Cap	179	116	49	62	14	205	10
150U.C.	214	138	59	75	16	243	13
150Cap	286	184	79	98	22	324	16
200U.C.	286	184	79	98	22	324	16
200Cap	362	249	86	114	33	438	19
265U.C.	362	249	86	114	33	438	19
250Cap	445	298	111	143	38	514	22
300Cap	445	298	111	143	38	514	22
330U.C.	445	298	111	143	38	514	22
400U.C.	556	362	127	171	44	635	25



**Two Line
Horizontal Arrow**

Letter Sizes	Dimensions in Inches						
	A	B	C	D	E	F	R
4U.C., 4Cap	7-1/8	4-1/8	1-9/16	1-15/16	7/16	6-3/8	5/16
5Cap	9	5-3/16	1-15/16	2-7/16	9/16	8-1/16	3/8
6U.C.	10-11/16	6-3/16	2-5/16	2-15/16	5/8	9-9/16	1/2
6Cap	14-1/4	8-1/4	3-1/8	3-7/8	7/8	12-3/4	5/8
8U.C.	14-1/4	8-1/4	3-1/8	3-7/8	7/8	12-3/4	5/8
8Cap	18-3/4	10-7/8	3-3/4	5	1-5/16	17-1/4	11/16
10.67U.C.	18-3/4	10-7/8	3-3/4	5	1-5/16	17-1/4	11/16
10Cap	23-13/16	13-13/16	4-1/2	6	1-1/2	20-1/4	3/4
12Cap	23-13/16	13-13/16	4-1/2	6	1-1/2	20-1/4	3/4
13.3U.C.	23-13/16	13-13/16	4-1/2	6	1-1/2	20-1/4	3/4
16U.C.	28-1/2	16-1/2	5-3/8	7-1/8	1-3/4	25	1

Letter Sizes	Dimensions in Millimeters						
	A	B	C	D	E	F	R
100U.C., 100Cap	181	105	40	49	11	162	8
125Cap	229	132	49	62	14	205	10
150U.C.	271	157	59	75	16	243	13
150Cap	362	210	79	98	22	324	16
200U.C.	362	210	79	98	22	324	16
200Cap	476	276	95	127	33	438	17
265U.C.	476	276	95	127	33	438	17
250Cap	605	351	114	152	38	514	19
300Cap	605	351	114	152	38	514	19
330U.C.	605	351	114	152	38	514	19
400U.C.	724	419	137	181	44	635	25

Gerry Muis
CHIEF, OFFICE OF SIGNS AND DELINEATION

8/1/02

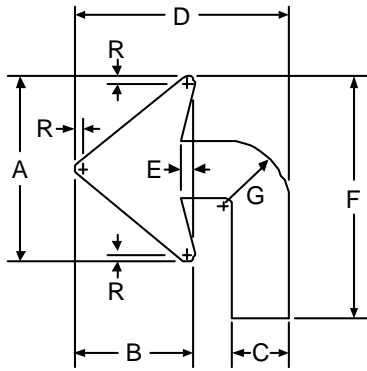
DATE

REVISION

REVISION

STATE OF CALIFORNIA - DEPARTMENT OF TRANSPORTATION

Standard Arrows for Directional Signs

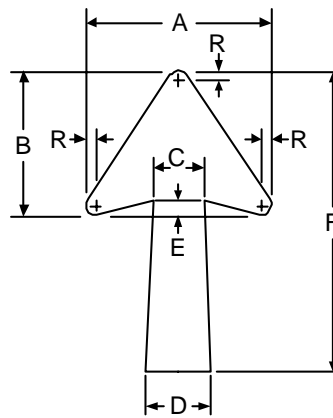


Advance Arrow

Letter Sizes	Dimensions in Inches							
	A	B	C	D	E	F	G	R
6U.C.	8-7/16	5-7/16	2-5/8	9-3/4	5/8	11-1/4	3R	1/2
6Cap	11-1/4	7-1/4	3-1/2	13	7/8	15	4R	5/8
8U.C.	11-1/4	7-1/4	3-1/2	13	7/8	15	4R	5/8

Letter Sizes	Dimensions in Millimeters							
	A	B	C	D	E	F	G	R
150U.C.	214	138	67	248	16	286	76R	13
150Cap	286	184	89	330	22	381	102R	16
200U.C.	286	184	89	330	22	381	102R	16

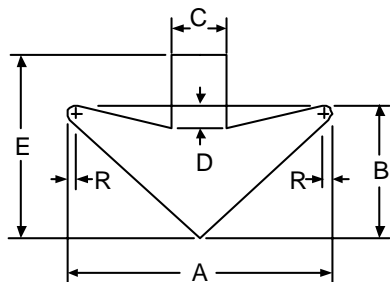
Two Line Vertical or Diagonal Arrow



NOTE:
The angle for a diagonal arrow is measured from the vertical.

Letter Sizes	Dimensions in Inches						
	A	B	C	D	E	F	R
4U.C., 4Cap	5-5/8	4-3/8	1-9/16	1-15/16	7/16	9-1/8	5/16
5Cap	7-1/16	5-1/2	1-15/16	2-7/16	9/16	11-1/2	3/8
6U.C.	8-7/16	6-9/16	2-5/16	2-15/16	5/8	13-11/16	1/2
6Cap	11-1/4	8-3/4	3-1/8	3-7/8	7/8	18-1/4	5/8
8U.C.	11-1/4	8-3/4	3-1/8	3-7/8	7/8	18-1/4	5/8
8Cap	15-1/8	11-9/16	3-3/4	5	1-5/16	24-1/4	3/4
10.67U.C.	15-1/8	11-9/16	3-3/4	5	1-5/16	24-1/4	3/4
10Cap	18-1/4	14	4-1/2	6	1-1/2	29-1/4	7/8
12Cap	18-1/4	14	4-1/2	6	1-1/2	29-1/4	7/8
13.3U.C.	18-1/4	14	4-1/2	6	1-1/2	29-1/4	7/8
16U.C.	22-1/4	17	5-3/8	7-1/8	1-3/4	35-5/8	1

Letter Sizes	Dimensions in Millimeters						
	A	B	C	D	E	F	R
100U.C., 100Cap	143	111	40	49	11	232	8
125Cap	179	140	49	62	14	292	10
150U.C.	214	167	59	75	16	348	13
150Cap	286	222	79	98	22	464	16
200U.C.	286	222	79	98	22	464	16
200Cap	384	294	95	127	33	616	19
265U.C.	384	294	95	127	33	616	19
250Cap	464	356	114	152	38	743	22
300Cap	464	356	114	152	38	743	22
330U.C.	464	356	114	152	38	743	22
400U.C.	565	432	137	181	44	905	25



Vertical Down Arrow

Dimensions in Inches					
A	B	C	D	E	R
24	12	5	2	16-1/2	3/4
32	16	6-1/2	3	22	1

Dimensions in Millimeters					
A	B	C	D	E	R
610	305	127	51	419	19
813	406	165	76	559	25

Gerry Kjer
CHIEF, OFFICE OF SIGNS AND DELINEATION

8/1/02

DATE

REVISION

REVISION

POLICY: G20-9

The CARPOOL LANE DESIGNATION sign (G20-9) should be used on a multilane cross street approaching an HOV drop ramp to indicate the proper lane to directly enter the HOV facility from the cross street.

The sign should be placed far enough in advance of the HOV drop ramp to permit a motorist to get into the proper lane.

POLICY: G83-3

The CARPOOLS ONLY, EXIT ONLY sign (G83-3) should be used at a freeway off-ramp or freeway to freeway direct connector that can be accessed only from an HOV lane where an auxiliary lane is installed.

POLICY: G84-1

The HOV Lane EXIT sign (G84-1) should be used at exit ramp gores on HOV drop ramps to identify the exiting point for High-Occupancy Vehicles. The arrow should be aligned to approximately the angle of departure.

As much as possible, the sign should be positioned to avoid confusion that the exit may also serve mixed flow traffic.

POLICY: G85-7

The HOV Lane ACTION sign (G85-7) shall be used for exiting traffic for buffered and barriered HOV facilities and is generally located near the beginning of the egress locations. The sign repeats the destination shown on the Primary Directional sign (G86) and is generally located downstream from it.

POLICY: G85-8

The HOV Lane ACTION sign (G85-8) shall be used for exiting traffic for buffered and barriered HOV facilities and is generally located near the beginning of the egress locations. The sign repeats the

destination shown on the Primary Directional sign (G86) and is generally located downstream from it.

POLICY: G85-9

The CARPOOLS ONLY, EXIT ONLY, ACTION sign (G85-9) shall be used at a freeway off-ramp or freeway to freeway direct connector that can be accessed only from an HOV lane.

POLICY: G86-8

The HOV Lane PRIMARY DIRECTIONAL sign (G86-8) should be used to give advance notice of egress locations for buffered and barriered HOV facilities and is located upstream from the action sign.

POLICY: G86-9

The HOV Lane PRIMARY DIRECTIONAL sign (G86-9) should be used to give advance notice of egress locations for buffered and barriered HOV facilities and is located upstream from the action sign.

POLICY: G86-10

The CARPOOLS ONLY, LEFT EXIT Primary Directional sign (G86-10) should be used in advance of an HOV drop ramp that can be accessed only from an HOV lane.

POLICY: G92-1

The CARPOOL LANE ENTRANCE sign (G92-1) shall be used at the entrance to an HOV drop ramp.

This sign is similar to the FREEWAY ENTRANCE sign (G92) and shall be installed similarly.

POLICY: R82-1

The CARPOOL LANE AHEAD, ½ MILE sign (R82-1) shall be used to indicate the distance to the beginning of an HOV facility.

POLICY: R82B

The ___AM - ___AM, ___PM - ___PM, MON - FRI sign (R82B) shall be used to designate the period of HOV operation for part time HOV facilities.

It is generally used with the CARPOOL LANE AHEAD, ½ MILE sign (R82-1).

POLICY: R84-1

The END CARPOOL LANE sign (R84-1) shall be used to designate the end of an HOV lane for contiguous, buffered, or barriered HOV facilities.

It is located at the end of the HOV Lane and generally downstream from the CARPOOL LANE ENDS, ½ MILE sign (R84-2).

POLICY: R84-2

The CARPOOL LANE ENDS, ½ MILE sign (R84-2) shall be used to indicate the distance to the end of an HOV lane.

It is located in advance of the END CARPOOL LANE sign (R84-1).

POLICY: R86

The LEFT LANE, CARPOOLS ONLY, ___AM - ___AM or ___PM - ___PM, MON - FRI sign (R86) shall be used when the left lane is designated as a carpool only lane during specified times and reverts to mixed flow operation.

The sign is generally located at the beginning of the HOV lane. It is also used in tandem with the CARPOOL IS ___ OR MORE PERSONS PER VEHICLE sign (R93-2) and repeated as a package.

POLICY: R86-2

The LEFT LANE, CARPOOLS ONLY sign (R86-2) shall be used when the left lane is designated for carpool only on a full time basis.

The sign is generally located at the beginning and at ingress/egress points of the HOV facility. It is also used in tandem with the CARPOOL IS ___ OR MORE PERSONS PER VEHICLE sign (R93-2) and repeated as a package. It may also be used by itself as needed between long intervals without on-ramps or ingress/egress locations.

POLICY: R86-3

The LEFT LANE, CARPOOLS ONLY, ___AM - ___AM, ___PM - ___PM, MON - FRI sign (R86-3) shall be used when the left lane is designated as a carpool only lane during specified times and reverts to mixed flow operation.

The sign is generally located at the beginning of the HOV lane. It is also used in tandem with the CARPOOL IS ___ OR MORE PERSONS PER VEHICLE sign (R93-2) and repeated as a package.

POLICY: R87-1

The CARPOOLS ONLY, ___ OR MORE PERSONS PER VEHICLE sign (R87-1) shall be used near the beginning of the HOV facility and at ingress/egress locations to restrict the lane to High-Occupancy Vehicles and to indicate occupancy requirements for buffered or barriered HOV facilities. It may also be used at the beginning of contiguous HOV facilities.

POLICY: R87-2

The CARPOOLS ONLY, ___ OR MORE PERSONS PER VEHICLE sign (R87-2) shall be used to restrict the HOV drop ramps for High-Occupancy Vehicles only and to indicate the number of persons required per vehicle.

POLICY: R91-2

The NO TRUCKS OVER 5 TONS OR VEHICLES WITH TRAILERS sign (R91-2) may be placed adjacent to the HOV lane, as needed, where incidences of trucks or vehicles with trailers in the HOV lanes have commonly occurred and on surface streets approaching HOV drop ramps.

POLICY: R93A

The VEHICLES WITH DMV CLEAN AIR DECAL OK sign (R93A) when used shall be placed below the R91, R91-1, R91-3 or R93-2 sign.

See CVC 21655.9.

POLICY: R93-2

The CARPOOL IS ___ OR MORE PERSONS PER VEHICLE sign (R93-2) shall be placed near the beginning of HOV facilities. It is also used in tandem with the LEFT LANE, CARPOOLS ONLY sign (R86-2) and repeated as a package.

POLICY: SR50-1

The CARPOOL VIOLATION \$ ___ MINIMUM FINE sign (SR50-1) may be used to supplement the SR50-2 sign on HOV facilities where violation rates are particularly high. It is normally a retrofit situation where the sign can be “piggybacked” onto an existing overhead sign where the support is structurally adequate to support the additional sign.

POLICY: SR50-2

The CARPOOL VIOLATION \$ ___ MINIMUM FINE sign (SR50-2) should be placed near the beginning of all HOV facilities and may be placed at ingress/egress locations for buffered or barriered HOV facilities. The sign may be repeated at 3.2 km (2-mile) intervals or as needed at locations experiencing high violation rates.

POLICY: W11-1

The HOV Lane Reduction Transition sign (W11-1) should be used to warn of a reduction in the number of HOV lanes.

It is not to be used in advance of the end of an acceleration lane.

POLICY: W59-1

The HOV Lane Merge symbol sign (W59-1) should be used in advance of locations where HOV lanes converge. This includes HOV drop ramps where high speeds and volumes prevail and merging or weaving must be accomplished in a relatively short distance.

This sign is similar to the Merge symbol sign (W59) and should be installed similarly.

POLICY: W72B

The HOV ADVISORY EXIT (RAMP) SPEED sign (W72B) when used, should be placed on the left of an HOV drop ramp or freeway to freeway connector to advise motorists of the speed at which the drop ramp or freeway to freeway connector can be comfortably negotiated.

POLICY: W74-1

The HOV Lane THRU TRAFFIC MERGE RIGHT (LEFT) sign (W74-1) should be used to inform motorists that the outside or inside lane of an HOV facility with two or more directional HOV lanes is being dropped at the next exit and through HOV traffic must merge into the adjacent HOV lane.

This sign should not be used for a lane reduction. See the HOV LANE ENDS MERGE RIGHT (LEFT) sign (W75-1).

POLICY: W75-1

The HOV LANE ENDS MERGE RIGHT (LEFT) sign (W75-1) should be used on an HOV facility to warn of the reduction in the number of HOV lanes.

APPENDIX 5A

POLICY: G26-1

The US Route Shield sign (G26-1) should be used when being placed on a guide sign.

POLICY: G27-1

The Interstate Route Shield sign (G27-1) should be used when being placed on a guide sign.

POLICY: G28-1

The State Route Shield sign (G28-1) should be used when being placed on a guide sign.

Standard Arrowhead for Warning & Regulatory Signs

**Standard Arrows for Directional Signs
(2 sheets)**



Section 6.1 General

Adequate enforcement of HOV violations is a necessary element for a successful HOV system. The threat of receiving a citation for an occupancy violation is a strong deterrent to the illegal use of the HOV lanes and studies have shown that violation rates increase when enforcement levels are low. Therefore, enforcement considerations must be accounted for during the planning, design, and operational phases of all HOV projects. The California Highway Patrol (CHP) involvement in all phases of development is beneficial. The CHP is the responsible agency in HOV lane enforcement issues, and they are an integral part of ensuring a successful HOV facility.

Section 6.2 Role of Enforcement

Experience with HOV facilities has clearly demonstrated that enforcement is required to develop an appropriate public attitude toward these facilities. In fact, the presence of a CHP officer has a beneficial impact. Such benefits usually correlate directly to the level of the officer's presence and are related to the motorist's perception of the extent of enforcement. In addition, this perception can be affected by the following factors:

- ◆ How frequently are enforcement units observed?
- ◆ Are enforcement units observed issuing citations?
- ◆ Are the fines sufficiently high to deter the illegal use of the HOV facility?
- ◆ Is the enforcement unit moving with the flow of traffic or is it parked?

A properly designed enforcement program is essential to the success of HOV facilities. The role of enforcement is to ensure proper implementation and compliance of the program. California Vehicle Code (CVC) Section 2400 places enforcement responsibility for State highways constructed as freeways under the jurisdiction of the CHP. It follows that the enforcement of laws relative to HOV facilities falls under the jurisdiction of the CHP. The Judicial Council of California (JCC) sets the fines and maintains the Uniform Bail and Penalty Schedule (UBPS) for traffic violations. See Appendices A-7 through A-10, California Vehicle Code Section 42001.11, Traffic Penalty Schedule and the California Penal Code for further explanation of minimum violation fines.

Section 6.3 Violation Rates

The task of keeping violation rates within reasonable bounds implies an ability to determine an acceptable violation rate. Based on California's HOV operations, a rate below ten percent (10%) is preferable. Establishing a standard for acceptable violation rates on a particular facility should include safety considerations, freeway operations, public attitudes, and practicality.

A. Safety Considerations

Past studies suggest there is no consistent correlation between accident rates and occupancy violation rates on any of California's HOV facilities. However, the practice of weaving in and out of a HOV lane creates a safety issue for the violator as well as for other traffic.

B. Freeway Operations

Many of California's HOV facilities are operating near capacity. As traffic flow approaches capacity, violations

represent a threat to the timesavings and other benefits of HOV facilities.

C. Public Attitudes

Even where there is intense public sentiment against the HOV facility, drivers recognize violations as a problem. Drivers tend to over-estimate violation rates and are likely to be critical if actual violation rates are above 10%.

D. Practicality

Experience suggests that routine enforcement combined with moderate applications of heightened enforcement can keep HOV violation rates within the 5% to 10% range. Consistent heightened enforcement would be necessary to drive violation rates below 5% and would have little effect on freeway performance. It is recommended that a target level below 10% be considered for mainline HOV facilities.

Section 6.4 Enforcement Alternatives

Detection of occupancy violations by video technology is not yet sufficiently reliable to eliminate on-the-scene verification by an officer. Therefore, every effort should be made to provide enforcement areas for all HOV facilities. The following enforcement area configurations are listed in order of preference:

1. Continuous paved median 4.2m or wider in both directions for the length of the HOV facility. If space is available, additional enforcement areas may be built in conjunction with the 4.2m median.
2. When 4.2m continuous paved median shoulders are not possible, paved bi-directional enforcement areas spaced 3.2km to 4.8km apart should be built. A separation in the median barrier should be provided for CHP motorcycle officers to patrol the HOV facility in both directions of travel.
3. Where median width is limited, some combination of 1 and 2 should be included.
4. Paved directional enforcement areas spaced 3.2km to 4.8km apart and staggered to accommodate both directions when space limitations do not allow any of the above outlined considerations.
5. Where space is limited, directional enforcement areas located wherever right of way is available.

New HOV facilities should be built to provide adequate enforcement areas. Also, consideration should be given to adding enforcement areas to existing facilities where violation rates are consistently above 10%.

Figures 6.1, 6.2 and 6.3 represent typical enforcement areas for various median configurations mutually agreeable to Caltrans and the CHP. The widths shown for enforcement areas are 4.5m and 4.8m. However, design variations due to restrictive right of way, may indicate a lesser width is necessary. In such cases, 4.2m should be the minimum width for enforcement areas. The typical length is 400m although a minimum of 300m is acceptable. Any deviation from these typical configurations could lead to a perception of unsafe conditions by the CHP officer and result in non-use. Therefore, district alternatives, which deviate from the above options, should be resolved with the local CHP command and the appropriate Headquarters representatives. It is likely that building any enforcement areas will require an approved design exception fact sheet.

Other considerations for the design and operation of enforcement areas include the following:

- A. For buffered HOV facilities, the buffer should be carried full width adjacent to the enforcement area.
- B. Audible warning markers spaced 1.8m apart should be placed outside the lane striping, running parallel with the enforcement area boundary. See Warning Marker Detail, shown on Figures 6.1, 6.2 and 6.3, and Chapter 5, HOV Signs and Markings.
- C. The right shoulder should not be sacrificed to provide room for enforcement areas in the median except for extreme circumstances and only with the necessary approvals.
- D. Maintenance of enforcement areas should be routinely provided to avoid accumulation of debris. Excessive debris in enforcement areas may present hazards to CHP units and motorists.

- E. Ensure adequate drainage.
- F. Glare screens should not be installed adjacent to HOV enforcement areas. This will improve visibility and allow officers a possible escape route if an errant vehicle enters the enforcement area.
- G. Enforcement areas should be avoided at ingress/ egress locations for buffer or barrier separated HOV facilities.
- H. Enforcement areas should be avoided at curves. If possible, adequate sight distance should be provided.
- I. To protect officers from thrown or falling objects, enforcement areas should not be placed near overcrossings.
- J. Design features should ensure that enforcement areas are not perceived as traffic lanes.

Section 6.5 Other Enforcement Considerations

Enforcement techniques used on mainline HOV facilities will vary according to the design of the facility. While 4.2m paved median or enforcement areas are preferred options for new HOV facilities, they may not be possible for retrofit HOV facilities on existing freeways due to the lack of right of way. Existing facilities have a number of different geometric characteristics that impact enforcement strategies, as follows:

A. Median Width

HOV facilities created by retrofitting within the median frequently have no usable enforcement areas in the center of the freeway. The absence of a center median shoulder has an adverse impact on two important aspects of enforcement on these facilities: safety and visibility. Enforcement action on this facility requires that the violator be taken across congested mixed-flow lanes to the right shoulder. This maneuver is potentially hazardous and reduces the beneficial impact from visible enforcement.

B. Buffers

Three types of separations are currently in use on California HOV facilities:

1. Single barrier stripe (double yellow)
2. Painted barrier (two double yellow stripes)
3. Fixed barrier (concrete barrier)

Each type of separation presents special enforcement considerations. The single barrier stripe provides separation within existing, yet restricting, right of way. This type of treatment may also limit enforcement capabilities.

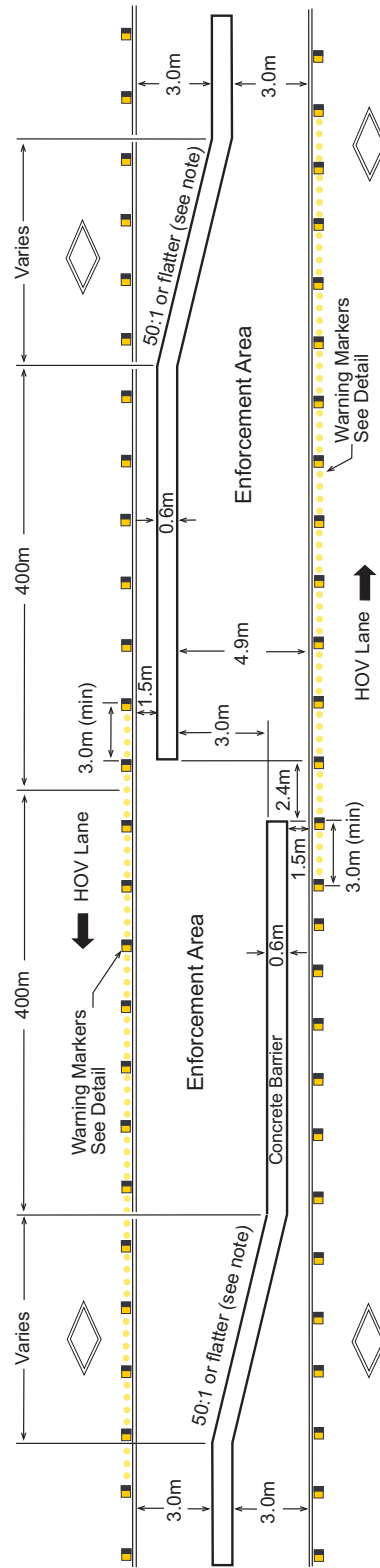
The painted barrier (buffer-separated) with two double yellow stripes presents a different enforcement challenge. If the buffer is wider than 1.2m, it creates the illusion that it may be a safe place to stop. Therefore, buffers between 1.2m and 3.6m should not be used.

The HOV facilities that are physically separated from the mixed-flow lanes by a fixed barrier (barrier-separated) tend to have the least number of occupancy violations. Any enforcement that takes place on these facilities requires an officer dedicated to that lane. The barrier may create an access issue for emergency vehicles.

The planning and design of enforcement areas must consider the impact on safety and visibility. Any deviation from the preferred geometrics requires a documented engineering analysis and a design exception approval. The optimum design is the availability of adequate enforcement areas in the median. Where existing facilities do not have these enforcement areas or new facilities are not designed with them, it can be expected that enforcement on the facility will be challenging.

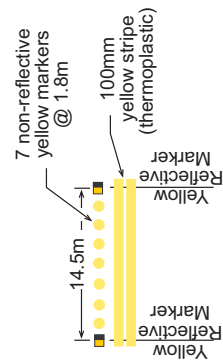
FIGURE 6.1
BI-DIRECTIONAL ENFORCEMENT AREAS
FOR 7.0m MEDIANS

NOT TO SCALE



BI-DIRECTIONAL ENFORCEMENT AREA

WARNING MARKER DETAIL



NOTE:

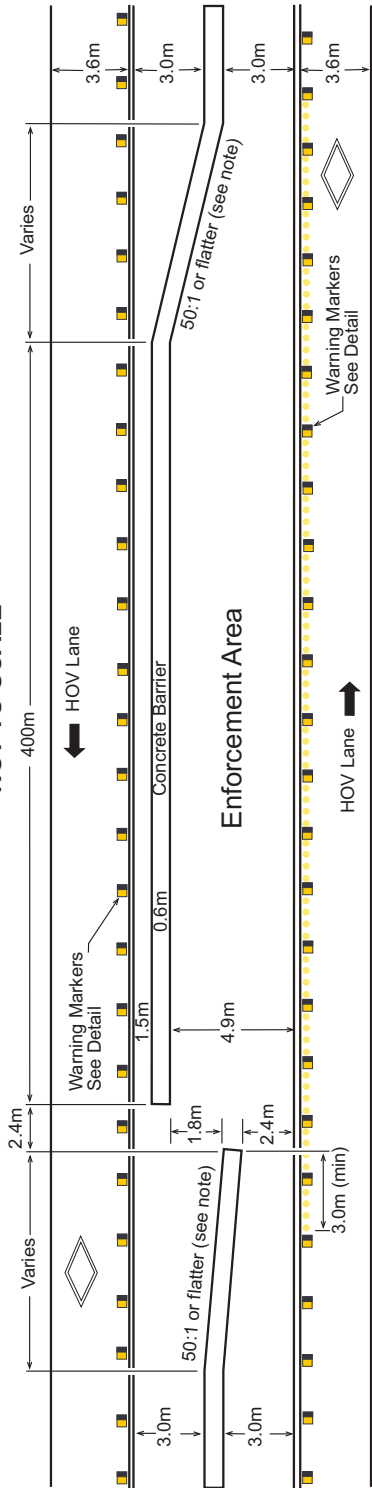
No glare screen within the enforcement area, including taper areas.

LEGEND:

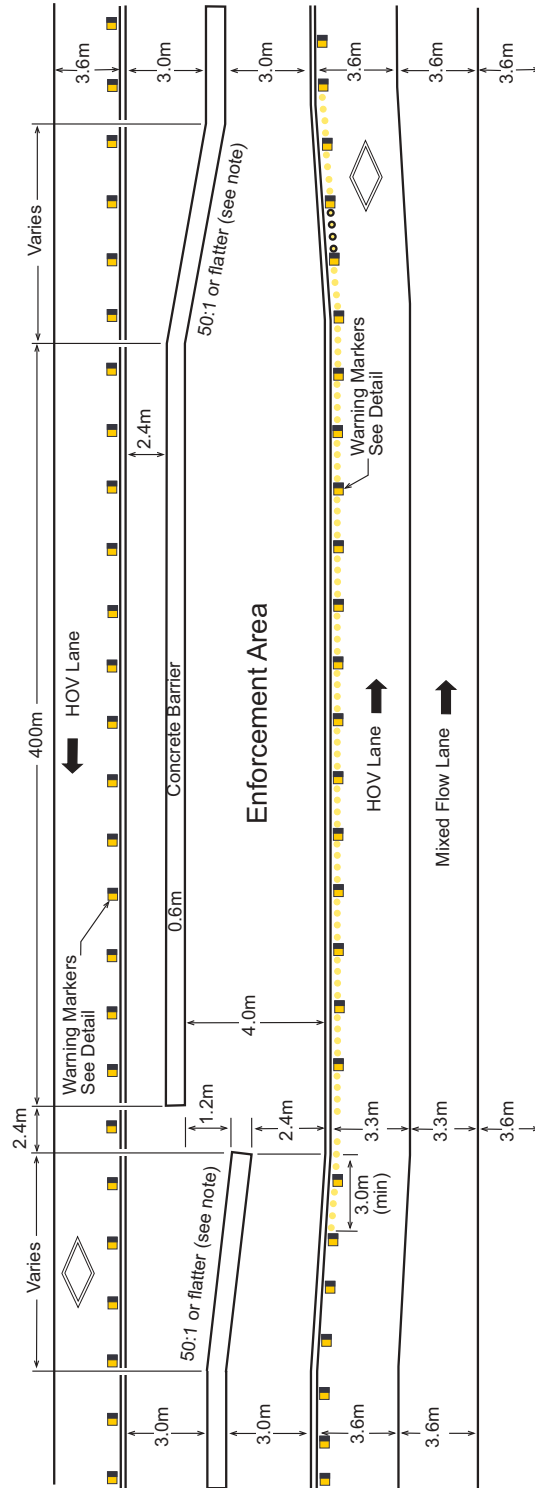
- NON-REFLECTIVE YELLOW MARKER
- ONE-WAY CLEAR REFLECTIVE MARKER
- ONE-WAY YELLOW REFLECTIVE MARKER
- 2 - ONE-WAY CLEAR REFLECTIVE MARKERS
- 100mm WHITE STRIPE (THERMOPLASTIC)
- 100mm YELLOW STRIPE (THERMOPLASTIC)
- 200mm WHITE STRIPE (THERMOPLASTIC)



FIGURE 6.2
DIRECTIONAL ENFORCEMENT AREAS
FOR 7.0m MEDIANS
NOT TO SCALE

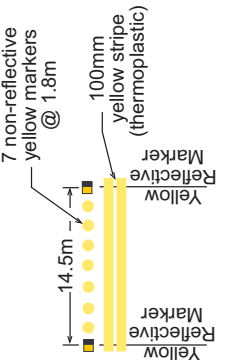


DIRECTIONAL ENFORCEMENT AREA
Alternative No. 1



DIRECTIONAL ENFORCEMENT AREA
Alternative No. 2

WARNING MARKER DETAIL



NOTE:
 No glare screen within the enforcement area, including taper areas.

LEGEND:

- NON-REFLECTIVE YELLOW MARKER
- ONE-WAY CLEAR REFLECTIVE MARKER
- ONE-WAY YELLOW REFLECTIVE MARKER
- 2 - ONE-WAY CLEAR REFLECTIVE MARKERS
- 100mm WHITE STRIPE (THERMOPLASTIC)
- 100mm YELLOW STRIPE (THERMOPLASTIC)
- 200mm WHITE STRIPE (THERMOPLASTIC)

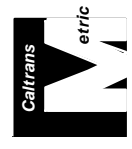
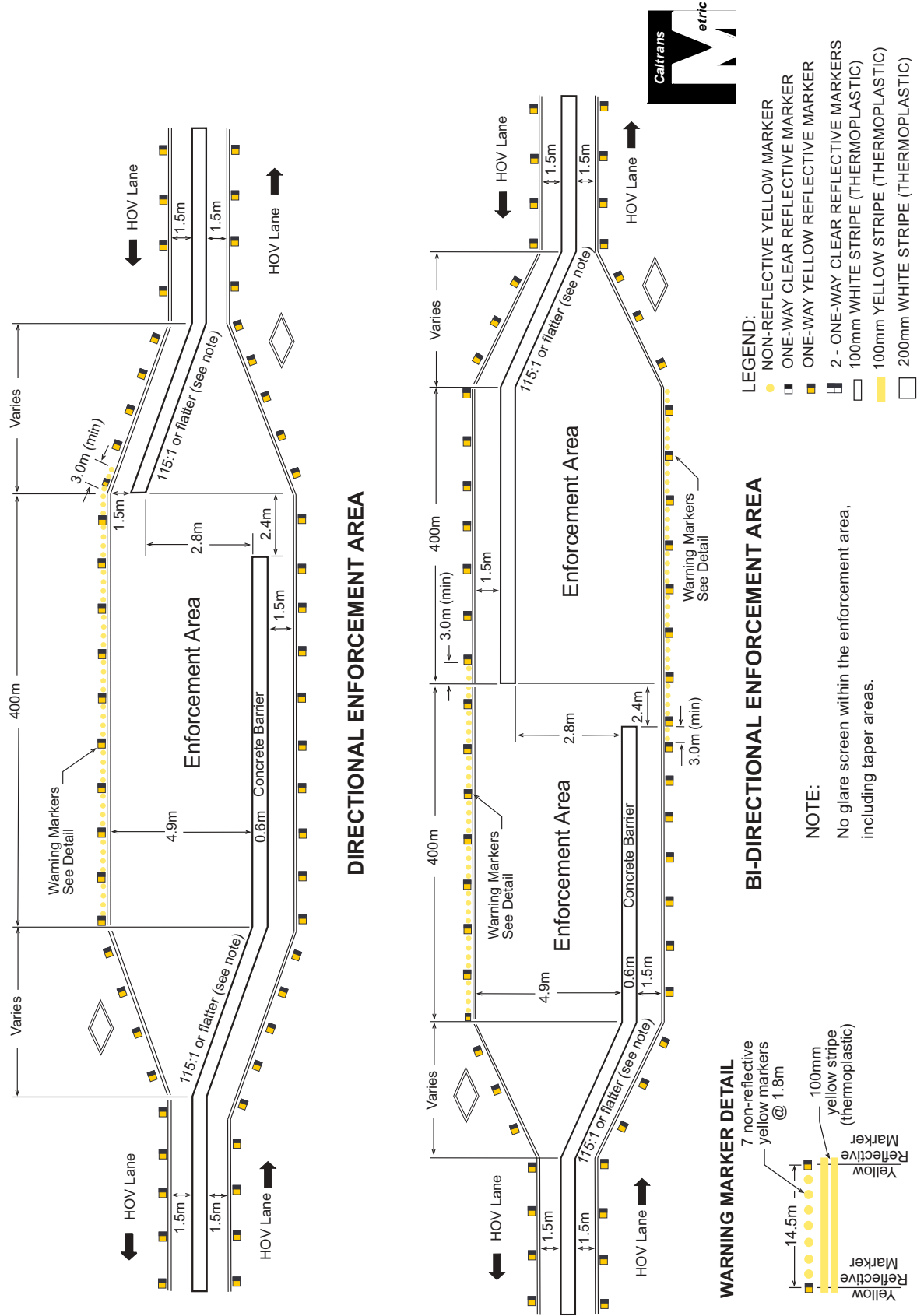


FIGURE 6.3
ENFORCEMENT AREAS FOR
MEDIANS LESS THAN 7.0m
NOT TO SCALE



HOV STATUTES AND POLICIES

Following is a partial listing of HOV related statutes and policies. Web addresses have been included where possible although availability may be subject to change. Hard copies of selected documents are indicated in *Italics* and included in this Appendix.

California Air Resources Board

- ◆ California Air Resources Board: Buyer's Guide to Cleaner Cars
<http://www.arb.ca.gov/msprog/ccbg/ccbg.htm>
- ◆ Transportation Performance Standards of the California Clean Air Act Executive Summary - HOV Systems Plans as Air Quality Control Measures

California Department of Transportation

- ◆ (1989) Policy and Procedure Memorandum P89-01
- ◆ (1991) Delegation of Authority for HOV Occupancy Determination, James W. Van Loben Sels
- ◆ (1995) *Deputy Directive DD-43*, see Appendix A-3
<http://admin.dot.ca.gov/bfams/deputydirectives/Internal/DD-43.pdf>
- ◆ (1995) *The Ending of High-Occupancy Vehicle (HOV) Lanes*, see Appendix A-4 and A-5

California Penal Code

<http://www.leginfo.ca.gov/cgi-bin/calawquery?codesection=pen&codebody=&hits=20>

California Transportation Commission

- ◆ (1987) *Bus and Carpool Lane Facilities Resolution G-87-8*, see Appendix A-6
<http://www.dot.ca.gov/hq/transprog/ctcliaison/Delegations/GRes-1978-1997.pdf>
- ◆ (1980) Policy Statement on Bus and Carpool Lanes

2003 California Vehicle Code (CVC)

Visit the Department of Motor Vehicles (DMV) website, see Appendix A-7 and A-8:

<http://www.dmv.ca.gov/pubs/vctop/vc/vctoc.htm>.

Most of the HOV related vehicle code sections are located in Division 11 of the CVC.

- ◆ Section 21460 Double Lines
- ◆ Section 21654 Slow-Moving Vehicles
- ◆ Section 21655 Designated Lanes for Certain Vehicles
- ◆ Section 21655.3 Permanent High-Occupancy Vehicle Lanes
- ◆ Section 21655.5 Exclusive- or Preferential- Use Lane for High-Occupancy Vehicles
- ◆ Section 21655.5(b) Mass Transit and Paratransit Vehicles may use HOV lanes regardless of occupancy
- ◆ Section 21655.6 Approval of Transportation Planning Agency or County Transportation Commission
- ◆ Section 21655.7 Use of Highway: Public Mass Transit Guideway
- ◆ Section 21655.8(a) Entering or Exiting Preferential- Use Lanes
- ◆ Section 21655.9 HOV Lanes: Use by Ultra-Low Emission Vehicles
- ◆ Section 21714 Three-Wheeled Vehicles: Operation in HOV Lanes

- ◆ Section 22364 Lane Speed Limits
- ◆ Section 22406 Maximum Speed for Designated Vehicles
- ◆ *Section 42001.11* *Violations of Provisions Governing HOV Lanes and \$271 minimum fine breakdown, see Appendix A-9 and A-10*

Federal Highway Act

- ◆ Title 23, Chapter 1, Subchapter I, Sec. 101, Definitions and Declaration of Policy; (A) Definitions, (2) Carpool Project
<http://www4.law.cornell.edu/uscode/23/101.html>
- ◆ *Title 23, Chapter 1, Subchapter I, Sec. 102, Program Efficiencies, see Appendix A-11*
<http://www4.law.cornell.edu/uscode/23/102.html>
- ◆ Title 23, Chapter 1, Subchapter I, Sec. 146, Use of High Occupancy Lanes
<http://www4.law.cornell.edu/uscode/23/146.notes.html>

Federal Highway Administration

- ◆ (2001) Request for Hybrid Vehicles to Use High Occupancy Vehicle (HOV) Lanes
<http://www.fhwa.dot.gov/legsregs/directives/policy/hybridmemo.htm>
- ◆ (2001) Program Guidance on High Occupancy Vehicle Lanes
<http://www.fhwa.dot.gov/legsregs/directives/policy/hovmemgd.htm>
- ◆ (1988) Memorandum Deleting 3+ Occupancy Requirement
- ◆ (1987) *Procedure Memorandum D6103, see Appendix A-12 and A-13*

Federal Register

- ◆ (2001) Volume 66, Number 88 [FHWA Docket FHWA-98-4300]
Transportation Equity Act for the 21st Century; Implementation for Participation in the Value Pricing Pilot Program
<http://www.fhwa.dot.gov/policy/frmay7.htm>

Judicial Council of California

- ◆ Traffic Infraction Fixed Penalty Schedule (California Vehicle Code Sections)

Public Resources Code

- ◆ Chapter 5.8, Section 25485

Streets and Highways Code

- ◆ Section 149 - The Carrell Act
Authority for Caltrans to Construct HOV Lanes
- ◆ Section 149.1 San Diego Association of Governments transit program
- ◆ Section 30101.8 Reduced Rates for High-Occupancy Vehicles

Surface Transportation Assistance Act (1982)

- ◆ Section 167

United States Code

- ◆ Amended Section 102 of Title 23
Intermodal Surface Transportation Efficiency Act (ISTEA) of 1991

DEPUTY DIRECTIVE**Number:** DD-43**Refer to
Director's Policy:** 08-Freeway System
Management**Effective Date:** 7-1-95**Supersedes:** P&P 89-10**Title:** High Occupancy Vehicle (HOV)
Systems**POLICY**

Caltrans uses High Occupancy Vehicle (HOV) systems as an effective traffic management strategy to promote carpooling and bus patronage, improve reliability of travel time, improve air quality, and maximize the efficiency of the freeway system by increasing its people-carrying capacity while reducing congestion and delay.

**DEFINITION/
BACKGROUND**

The Federal Highway Act, Title 23, authorizes the United States Department of Transportation to approve HOV facilities on Federal Aid Systems to increase the capacity for the movement of persons. Section 21655.5 of the California Vehicle Code and Section 149 of the Streets and Highways Code authorize the California Department of Transportation to construct preferential lanes for buses and other HOVs.

RESPONSIBILITIES

The Traffic Operations Program Manager develops, reviews and disseminates policies, guidelines and procedures for HOV systems.

The State and Local Project Development Program Manager develops and reviews geometric design standards, pavement structural section standards and drainage standards for HOV systems; and consults with Traffic Operations prior to approving design exceptions related to HOV systems.

The New Technology and Research Program Manager develops and reviews new technology applications for HOV systems.

The Transportation Planning Program Manager provides statewide direction for long-range state highway system planning leading to the identification of future highway improvements, including HOV system improvements.

District Directors implement HOV policies and procedures and coordinate with local agencies in establishing HOV systems.

APPLICABILITY

All Caltrans employees involved in HOV system activities.



ANDREW POAT
Chief Deputy Director

State of California

Business, Transportation and Housing Agency

M e m o r a n d u m

To: DISTRICT DIRECTORS
Districts 3, 4, 7, 8, 11 and 12

Date: December 11, 1995

File No :

From: DEPARTMENT OF TRANSPORTATION
Traffic Operations


Subject: The Ending of High Occupancy Vehicle (HOV) Lanes

Questions have been raised recently, including some by the Federal Highway Administration (FHWA), concerning the end treatment for HOV lanes. To clarify the issue, Headquarters Traffic Operations has determined that an HOV lane shall end in a continuing lane which enables the HOV traffic to continue without a merge. When a lane end has to occur it shall become the standard to drop the outside mixed flow lane as shown on the attached drawing. This issue was thoroughly discussed by a statewide task force, which included outside agencies such as FHWA, in the preparation of the HOV Guidelines. Although the opinion was expressed that the Guidelines should include instructions for both left and right side merges, the overwhelming belief was that merging the HOV lane is such an exception that including it would mislead the districts into believing that it is an equally desirable option. If an exception is needed, document the reasons and request an approving signature from the appropriate headquarters traffic reviewer.

Frequently, the ending of the HOV lane could be shifted up or downstream to make a right merge more feasible.

Revisions of plans are required for projects in the planning or design stage. For those HOV projects under construction with the HOV lane merging, I request that you review these projects and request contract change orders as needed.

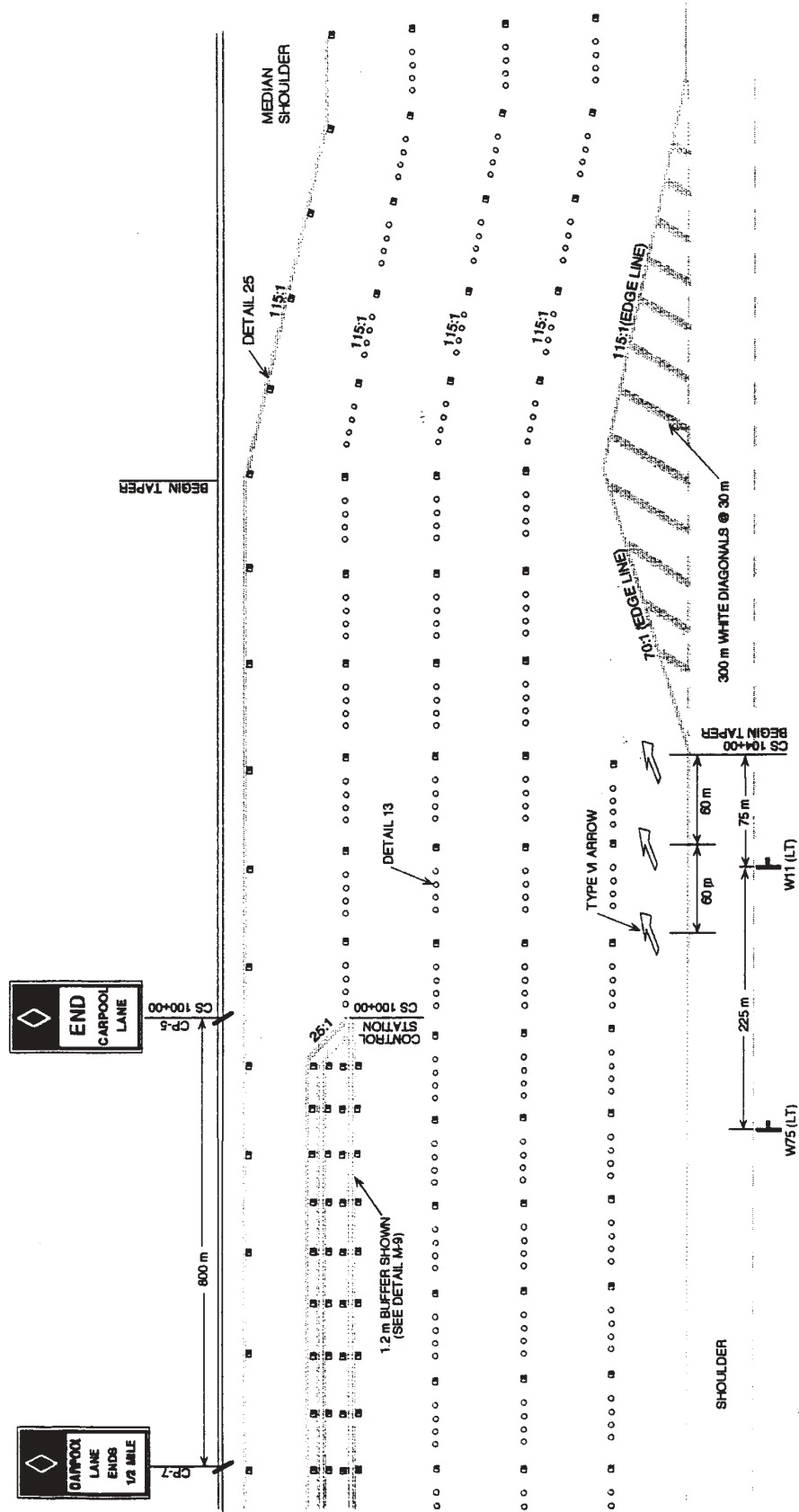
If you have any questions, please call your headquarters traffic reviewer.


JAMES B. BORDEN
Program Manager
Traffic Operations

*Attachment

* The original attachment is included on the subsequent page although superceded by Chapter 5, Detail M-6 of this Guideline, 2003 Edition.

TYPICAL END HOV TREATMENT WITH SIGNING AND PAVEMENT MARKINGS
 (Similar for Contiguous and Barrier Separated Facilities)



Superseded by Chapter 5,
 Detail M-6, 2003 Edition

California Transportation Commission
'G'
General Resolutions

CTC Resolution Index

Updated: October 13, 2000

Resolution	Status	Date Passed	Title/Description
1978-1982			
G-01	Replaced by G-23 as Replaced by G-50	April 21, 1978	Authorization for Department of Transportation (Caltrans) to submit a list of Proposed STIP projects at each April CTC Meeting for the purpose of advertising certain projects prior to the fiscal year in which funds are appropriated, with contract award pending appropriation of funds by the Legislature, and adoption of the STIP. See related Resolutions G-09 and G-16. Resolution G-01 Replaced by G-23 as Replaced by G-50
G-02	Amended by G-95-07 G-96-26 G-97-12 G-98-22	July 28, 1978	Procedure for sale of excess lands / property. Resolution G-02 Amended by Resolution G-95-07 Resolution G-02 Amended by Resolution G-96-26. Resolution G-02 Amended by Resolution G-97-12. Resolution G-2 Amended by Resolution G-98-22
G-03	Original	July 28, 1978	Procedure for lease of excess lands / property for park purposes to local agencies. See related Resolution G-91.
G-04	Original	July 28, 1978	Procedures relating to Resolutions of Necessity to acquire property by eminent domain.
G-05	Replaced by G-94-13, G-96-27 and G-97-06	Aug 10, 1994	Procedure for leasing airspace to private entities. Resolution G-05 Replaced by Resolutions G-94-13, G-96-27 and G-97-06.
G-06	Original	July 28, 1978	Procedure for leasing airspace to public agencies.
G-07	Not Used		No Resolution On File.
G-08	Replaced by G-15	May 19, 1978	Procedure for recycling / rescinding adoption of freeway locations. Resolution G-08 Replaced by Resolution G-15.
G-09	Original	April 21, 1978	Affirmation of California Highway Commission approval of FY 1978-79 construction projects (Partial List) - See Related Resolutions G-01 and G-16.
G-10	Replaced by G-88-21	May 19, 1978	Adoption of toll rate schedule for the Antioch Toll Bridge. Resolution G-10 Replaced by Resolution G-88-21.
G-11	Amended and Superseded by G-94 and Amended by G-00-11	Jun 23, 1978	Authorization for Department of Transportation (Caltrans) to allocate funds for emergency projects. Resolution G-11 Amended and Superseded by G-94.
G-12	Amended and Superseded by G-95-08	Jul 28, 1978	Delegation of authority to Department of Transportation (Caltrans) to adjust project allocations and modify project descriptions. Resolution G-12 Amended by Resolutions G-83-06, G-85-10, G-88-04, G-88-18, G-88-23, and G-90-24, which were subsequently Replaced and Superseded by G-95-08.
G-13	Replaced by G-91-01	Jun 23, 1978	Delegation of authority to Department of Transportation (Caltrans) to sub-allocate right of way funds. Resolution G-13 Replaced by Resolution G-91-01.
G-14	Original	Nov 17, 1978	Procedure for adoption of freeway route locations.
G-15	Replaces G-08	Feb 29, 1980	Procedure for recycling / rescinding adopted freeway locations and policy for conditional retention of adoptions. Resolution G-15 Replaces Resolution G-08.
G-16	Original	Aug 25, 1978	Affirmation of California Highway Commission approval of FY 1978-79 construction projects (balance of projects) See related Resolutions G-01 and G-09.



ADDITIONAL HOV INFORMATION

California Vehicle Code sections relating to HOV lanes:

To view the 2003 California Vehicle Code (CVC), visit the Department of Motor Vehicles (DMV) website: <http://www.dmv.ca.gov/pubs/vctop/vc/vctoc.htm>. Most of the HOV related vehicle code sections summarized below are located in Division 11 of the CVC. Section titles in **BOLD** indicate official title names as shown in the CVC. The section title in regular font was included for clarity in describing the HOV related issue.

- | | |
|--------------------|--|
| Section 21460 | <p>Double Lines
The purpose of the solid-white single line on the inside of the double yellow lines on buffered HOV lanes is to permit vehicles to legally drive to the left of the double yellow lines as defined in the provisions of this section.</p> |
| Section 21654 | <p>Slow-Moving Vehicles
This section requires vehicles, such as those with 3-or-more-axles or vehicles with trailers as defined in Section 22406, to use the farthest right freeway lanes. Therefore, these vehicles cannot use the HOV lanes.</p> |
| Section 21655 | <p>Designated Lanes for Certain Vehicles
Allows the Department of Transportation or local authorities to designate specific lanes for vehicles required to drive at reduced speeds. Requires vehicles driving at reduced speeds to use the farthest right lanes.</p> |
| Section 21655.3 | <p>Permanent High-Occupancy Vehicle Lanes
After 1/1/87, but before 12/31/87 all permanently designated HOV lanes operating 24 hours a day shall be separated from general use highway lanes by a minimum 4 foot wide buffer.</p> |
| Section 21655.5 | <p>Exclusive- or Preferential- Use lanes for High-Occupancy Vehicles
Allows the Department of Transportation and local authorities to designate specific lanes for HOV preferential use upon completion of competent engineering estimates made of the effects of the lanes on safety, congestion, and highway capacity.</p> |
| Section 21655.5(b) | <p>Mass Transit and Paratransit Vehicles
Enactment of SB 236 on January 1, 1998, permits mass transit vehicles to use the HOV lanes without meeting the occupancy requirement.</p> <p>Enactment of AB 2582 on January 1, 2003, permits <u>clearly marked</u> paratransit vehicles to use the HOV lanes without meeting the occupancy requirement. This section also requires that HOV lane-use comply with posted signs designating the minimum occupancy requirement.</p> |
| Section 21655.6 | <p>Approval of Transportation Planning Agency or County Transportation Commission
Requires the Department of Transportation to have approval of the county transportation commission prior to establishing new HOV lanes.</p> |
| Section 21655.7 | <p>Use of Highway: Public Mass Transit Guideway
Allows for any portion of a highway to be designated for exclusive public mass transit use.</p> |
| Section 21655.8(a) | <p>Entering or Exiting Preferential-Use Lanes
A citation for violation of the provisions of this section, commonly called a buffer violation, carry a minimum fine of \$271.</p> |

-
- Section 21655.9 **HOV Lanes: Use by Ultra – Low Emission Vehicles**
Website for list of vehicles that meet federal requirements and qualify as ultra-low emission vehicles (ULEV) and super ultra low-emission vehicles (SULEV) in Assembly Bill 71, enacted July 1, 2000:
<http://www.arb.ca.gov/msprog/carpool/carpool.htm>
- Section 21714 **Three-Wheeled Vehicles: Operation in HOV Lanes**
Prohibits three-wheeled vehicles from using the HOV lanes.
- Section 22364 **Lane Speed Limits**
Allows the Department of Transportation to post the appropriate speed for designated lanes.
- Section 22406 **Maximum Speed for Designated Vehicles**
By definition in this section, trucks with three or more axles, or vehicles with trailers, are not allowed to use the HOV lanes because they cannot drive the maximum legal speed limit posted on HOV lanes in California. Provisions of Section 21654 (above) then apply.

Definition of Two-Seat Vehicles (used in San Francisco Bay Area only):

Applies to the Interstate 80 HOV lanes and the toll plaza HOV by-pass lanes in the Bay Area requiring 3 or more occupants. Two seat vehicles are exempt from the 3 or more person occupancy requirement where posted. However, they must still have two people in them to use a 3 or more person facility.

State Assemblyman John Burton's legislation, Assembly Bill 210, was implemented on October 1, 1995. The legislation amended Section 30101.8 of the Streets and Highways Code to read, "*.....grant the same toll-free passage and reduced-rate passage to class I vehicles designed by the manufacturer to be occupied by no more than two persons, including the driver, if these vehicles are occupied by two persons, including the driver.*"

How the \$271 Minimum Fine is Derived

The Judicial Council of California (JCC) sets the fines and maintains the Uniform Bail and Penalty Schedule (UBPS) for traffic violations. In that schedule the fine is \$270 for an occupancy violation per Section 21655.5(b) or a buffer violation per Section 21655.8(a) of the CVC.

The \$270 set by the JCC, a minimum, is comprised of:

- (1) Section 1464 of the Penal Code setting \$170 and
- (2) Section 42001.11 of the CVC setting a \$100 minimum to \$150 maximum for first offense, \$150 minimum to 200 maximum for second offense within 1 year, and \$250 to \$500 for third offense within 2 years.

The additional \$1 assessment is under Section 42006 of the CVC for counties that have night court.

In addition, the counties can assess an additional \$10 for administration, at the discretion of the county's Board of Supervisors, under Section 40508.6 of the CVC. Also, Section 1463.28 of the Penal Code provides for 30 counties to exceed fines scheduled in the UBPS. In the San Francisco Bay Area, the only county that can do this is Contra Costa.

All of the counties that have HOV lanes also have night court, so this is why the posted sign shows \$271 minimum.

Uniform Traffic Penalty Schedule

40310. The Judicial Council shall annually adopt a uniform traffic penalty schedule which shall be applicable to all nonparking infractions specified in this code, unless in a particular case before the court the judge or authorized hearing officer specifies a different penalty. No penalty shall be established for any infraction in an amount, exclusive of any additional penalty levied pursuant to Section 1464 of the Penal Code, in excess of the amount of the maximum fine pursuant to Section 42001 or 42001.5, and penalties shall be set without regard to residence. In case a traffic penalty is not paid within 20 days following mailing of a notice that the penalty has been assessed, a late charge shall be due in the amount of 50 percent of total initial penalty. In establishing a uniform traffic penalty schedule, the Judicial Council shall classify the offenses into four or fewer penalty categories, according to the severity of offenses, so as to permit convenient notice and payment of the scheduled penalty

Amended Ch. 696, Stats. 1992. Effective September 15, 1992.

JUDICIAL COUNCIL OF CALIFORNIA TRAFFIC INFRACTION FIXED PENALTY SCHEDULE (Vehicle Code Sections)

<u>Section</u>	<u>Offense</u>	<u>Base Fine</u>	<u>Added Penalty</u>	<u>Total Bail</u>	<u>Bail Category</u>	<u>Point Count</u>
21655.5(b)	Improper Use of Preferential Lanes	\$ 100	+ 170 =	\$ 270	4a	0
21655.8	Driving Over Double Lines of Preferential Lanes	\$ 100	+ 170 =	\$ 270	4a	1

2003 Vehicle Code General Provisions and Divisions

Exclusive or Preferential Use Lanes

42001.11. Every person convicted of an infraction for a violation of Section 21655.5 or 21655.8 shall be punished as follows:

(a) For a first conviction, a fine of not less than one hundred dollars (\$100), nor more than one hundred fifty dollars (\$150).

(b) For a second conviction within a period of one year, a fine of not less than one hundred fifty dollars (\$150), nor more than two hundred dollars (\$200).

(c) For a third or any subsequent conviction within a period of two years, a fine of not less than two hundred fifty dollars (\$250), nor more than five hundred dollars (\$500).

Added Ch. 1054, Stats. 1988. Effective January 1, 1989.

Title 23, United States Code (U.S.C.), Highways**Sec. 102. - Program efficiencies****(a) HOV Passenger Requirements. -**

(1) In general. - A State transportation department shall establish the occupancy requirements of vehicles operating in high occupancy vehicle lanes; except that no fewer than 2 occupants per vehicle may be required and, subject to section 163 of the Surface Transportation Assistance Act of 1982, motorcycles and bicycles shall not be considered single occupant vehicles.

(2) Exception for inherently low-emission vehicles. - Notwithstanding paragraph (1), before September 30, 2003, a State may permit a vehicle with fewer than 2 occupants to operate in high occupancy vehicle lanes if the vehicle is certified as an Inherently Low-Emission Vehicle pursuant to title 40, Code of Federal Regulations, and is labeled in accordance with, section 88.312-93(c) of such title. Such permission may be revoked by the State should the State determine it necessary.

(b) Access of Motorcycles. -

No State or political subdivision of a State may enact or enforce a law that applies only to motorcycles and the principal purpose of which is to restrict the access of motorcycles to any highway or portion of a highway for which Federal-aid highway funds have been utilized for planning, design, construction, or maintenance. Nothing in this subsection shall affect the authority of a State or political subdivision of a State to regulate motorcycles for safety.

(c) Engineering Cost Reimbursement. -

If on-site construction of, or acquisition of right-of-way for, a highway project is not commenced within 10 years (or such longer period as the State requests and the Secretary determines to be reasonable) after the date on which Federal funds are first made available, out of the Highway Trust Fund (other than Mass Transit Account), for preliminary engineering of such project, the State shall pay an amount equal to the amount of Federal funds made available for such engineering. The Secretary shall deposit in such Fund all amounts paid to the Secretary under this section.

Attachment to P 89-01, 3/16/89

FEDERAL HIGHWAY ADMINISTRATION CALIFORNIA DIVISION OFFICE PROCEDURE MEMORANDUM	
SUBJECT: Urban Freeway Reconstruction and HOV Projects	D6103
	Dec. 15, 1987

BACKGROUND

As our freeway systems mature, traffic increase has caused a continued reduction in the level of service. Professional transportation planners and engineers have found that there is no practical way to provide sufficient freeways to accommodate demand. In most urbanized areas, no new freeway corridors are proposed or available, except at extremely high cost. The existing freeway system, therefore, must be operated as efficiently as possible considering the collective public. One method of increasing existing freeway people-carrying capacity is to increase vehicle occupancy rate. More people can be moved with less energy and less air pollution while saving overall trip time. HOV lanes on urban freeways increase occupancy rates, and can move the equivalent person-trips of at least 3 conventional traffic lanes in peak hours thus often relieving overall congestion on the freeway.

As freeways are reconstructed, opportunities often exist to cost effectively add HOV lanes and thus substantially add people-carrying capacity to the reconstructed freeways. These opportunities should be fully considered in the planning and project development processes.

POLICY

- o Regional Transportation Planning Agencies (RTPA) should develop in concert with Caltrans and local agencies, route specific region-wide HOV system plans as a part of the regional transportation plan in metropolitan areas. The RTPA shall have the opportunity to comment on projects which deviate from the HOV system plan.
- o An HOV lane shall be an essential alternative for evaluation in the project development process when considering an additional lane by restriping and/or reconstruction or widening on freeways with three or more lanes in one direction.
- o Support by the public is an essential factor for a successful HOV facility. It is therefore desirable that a public relations program be incorporated into the project development process for all HOV facilities. This public relations program is necessary to create public awareness and acceptance of the positive attributes of the HOV option in reducing congestion and air pollution.
- o Freeway lanes, including HOV lanes, which are added by restriping and/or reconstruction or widening, and all other adjacent lanes and shoulders, shall be

Attachment to P 89-01, 3/16/89

constructed to full AASHTO geometric standards except as outlined below under Design Standards.

- o There is a minimum vehicle occupancy criterion of 3 persons per vehicle for HOV facilities. Exceptions to this criterion require FHWA approval.

DESIGN STANDARDS

The AASHTO publication "Guide for the Design of High Occupancy Vehicle and Public Transfer Facilities" gives guidance for design of HOV lanes. In general, lane width should be 12 feet. A 10-foot inside shoulder is desirable. Additional width within the median is encouraged at locations designated for enforcement.

Configurations which use less than full standard lane and shoulder widths require design exceptions. HOV facilities requiring design exceptions are considered staged development and serve as an interim means to relieve existing traffic congestion. When demonstrated effective, plans should be made to provide a standard cross-section to enhance safety and operational characteristics.

When a lane is added, either by restriping and/or reconstruction or widening, to a freeway with 3 or more lanes in one direction, exceptions to the AASHTO geometric standards will be considered in, but not limited to, the following situations:

- o The new lane proposed is an HOV lane.
- o The regional transportation plan includes an HOV system element favorably reviewed by Caltrans and FHWA and the proposed project is consistent with the HOV system element.
- o The regional transportation plan does not yet include a region-wide HOV system; the new lane could be a mixed-flow lane if five years after opening, at the peak commute hour and operating as an HOV lane, the lane would carry fewer person-trips than a mixed-flow lane.



Bruce E. Cannon
Division Administrator

HOV REPORT GUIDELINES

This report is designed specifically as a "stand alone" document to confirm with the requirements of Section 149 of the Streets and Highways Code and Section 21655.5 of the Vehicle Code. It is an attachment to the project report to address the effects of the HOV facility on safety, congestion and highway capacity.

I. INTRODUCTION

Describe project area and attach location map. The map should show the HOV system (if any) for the area, including existing HOV lanes, the proposed project and future HOV projects.

II. EXISTING CONDITIONS

Discuss and quantify delay* from recurrent congestion. This information may be obtained from the District's Statewide Highway Congestion Monitoring Program (HICOMP) report. Otherwise, field observations would be necessary to determine vehicle hours of delay.

*Delay is defined as the difference in travel time between the congested speed and 35-mph. Recurrent congestion occurs when speeds are at 35 mph or less on incident-free weekdays during rush hours for a time duration of 15 minutes or longer.

III. PROJECT ALTERNATIVES

Describe design and operational details of each alternative, including:

A. Existing Facility

1. Typical cross section

B. HOV

1. Typical cross section
2. Buffer type and width
3. Ingress/egress
4. Nonstandard features, if any
5. Enforcement areas
6. Will the facility operate one or both directions?
7. What are the operating times?
8. Minimum vehicle occupancy requirements?

C. Mixed Flow

1. Typical cross section
2. Nonstandard features, if any

IV. COMPARISON OF ALTERNATIVES

Discuss the effect of each alternative on congestion, capacity and safety. State assumptions and cite references as necessary. Traffic data may be available on PMCS, TASAS, or may be obtained by field measurement.

A. Effect on Congestion/Capacity (In all cases, projected data shall be based on the volumes anticipated 5 years after opening traffic)

1. Peak Period Volumes (Show hours used for peak period- AM/PM)

- a. Do Nothing - Show existing and projected peak period volumes for the existing facility.
- b. HOV - Estimate projected peak period volumes based on comparisons and existing similar HOV freeways statewide.
- c. Mixed Flow - Use projected peak period volumes based on the addition of an assumed mixed flow lane.

2. Persons Moved per Peak Period - Existing and Projected

- a. Do Nothing - Estimate existing vehicle occupancy distribution and multiply by present peak period volumes to equal total number of persons presently moved during the peak period. Repeat using projected peak period volumes for projected number of persons moved per peak period.
- b. HOV - Estimate vehicle occupancy distribution for both mixed flow and HOV lanes by comparing with existing similar HOV freeways statewide. Multiply each factor by projected peak volumes to estimate total number of persons moved.
- c. Mixed Flow - Use existing vehicle occupancy distribution and multiply by projected peak period flows for mixed flow option.

3. Peak hour volumes (PHV) and Level of Service (LOS)

(Refer to PMCS and the Highway Capacity Manual)

- a. Do Nothing - Calculated existing and projected LOS using the existing and projected PHV.
- b. HOV - Calculate a projected LOS for the HOV lane, and a projected LOS for the remaining mixed flow lanes, using the projected PHV.
- c. Mixed Flow - Calculate a projected LOS for a mixed flow freeway, using the projected PHV.

B. Effect on Safety**1. Accidents per Million Vehicle Miles (MVM)**

List actual and/or expected accident rates for each alternative.

- a. Do Nothing - Show actual rate for the 12 months prior to projected opening and expected rates for 12 months after projected opening.
- b. HOV - Show expected rate for 12 months after opening by comparing with statewide average.

V. OTHER CONSIDERATIONS

- A. Approval of Regional Planning Agencies
- B. Approval of FHWA (if required)
- C. Compliance with Air Quality Management District (AQMD) Regulations

VI. SUMMARY AND CONCLUSIONS

- A. Discuss the preferred project based on conclusions drawn from data presented
- B. Summary of Results

**SAMPLE TABLE
SUMMARY**

ALTERNATIVES	DIRECTION / # LANES	CONGESTION / CAPACITY										SAFETY	
		PEAK PERIOD VOLUMES				PERSONS MOVED / PEAK PERIOD				LEVEL OF SERVICE (LOS) - PEAK HR		ACCIDENTS/MILLION VEHICLE MILES (MVM)	
		EXISTING		PROJECTED		EXISTING		PROJECTED		EXISTING	PROJECTED	ACTUAL	EXPECTED
		AM	PM	AM	PM	AM	PM	AM	PM				
DO NOTHING	NB/4	22,000	24,000	24,000	25,300	25,300	27,600	27,600	E	F	.75	.60	
	SB/4	22,000	24,000	24,000	25,300	25,300	27,600	27,600	E	F			
HOV	NB/4+1	ME	ME	ME	ME	ME	ME	ME					
		24,000	24,000	24,000	26,400	26,400	26,400	26,400					
	HOV	HOV	HOV	HOV	HOV	HOV	HOV	HOV					
	3,600	3,600	3,600	7,920	7,920	7,920	7,920	7,920				.60	
SB/4+1	ME	ME	ME	ME	ME	ME	ME	ME					
	24,000	24,000	24,000	26,400	26,400	26,400	26,400	26,400					
NB/5	HOV	HOV	HOV	HOV	HOV	HOV	HOV	HOV					
	3,600	3,600	3,600	7,920	7,920	7,920	7,920	7,920					
MIXED FLOW	NB/5	30,000	30,000	30,000	34,500	34,500	34,500	34,500		F		.60	
	SB/5	30,000	30,000	30,000	34,500	34,500	34,500	34,500		F			

PEAK PERIOD: AM 6:00 to 9:00
PM 3:00 to 6:00

Notes:

1. Projected data is based on volumes anticipated 5 years after opening to traffic.
2. Peak period varies according to area.
3. Actual and expected rates shown for Accidents/MVM are yearly rates. Expected rates are based on comparisons with similar freeways.

SUMMARY

ALTERNATIVES	DIRECTION / # LANES	CONGESTION / CAPACITY										SAFETY				
		PEAK PERIOD VOLUMES				PERSONS MOVED / PEAK PERIOD				LEVEL OF SERVICE (LOS) - PEAK HR		ACCIDENTS/MILLION VEHICLE MILES (MVM)				
		EXISTING		PROJECTED		EXISTING		PROJECTED		EXISTING	PROJECTED	ACTUAL	EXPECTED			
		AM	PM	AM	PM	AM	PM	AM	PM							
DO NOTHING																
HOV																
			ME	ME												
			HOV	HOV												
			ME	ME												
MIXED FLOW			HOV	HOV												

PEAK PERIOD: AM ____ to ____
 PM ____ to ____

- Notes:
1. Projected data is based on volumes anticipated 5 years after opening to traffic.
 2. Peak period varies according to area.
 3. Actual and expected rates shown for Accidents/MVM are yearly rates. Expected rates are based on comparisons with similar freeways.