



**2000 MARYLAND  
STORMWATER DESIGN MANUAL  
VOLUME II  
STORMWATER DESIGN  
APPENDICES**



**MARYLAND DEPARTMENT OF THE ENVIRONMENT**  
WATER MANAGEMENT ADMINISTRATION  
2500 BROENING HIGHWAY • BALTIMORE MARYLAND 21224  
(410) 631-3543 1-800-633-6101 <http://www.mde.state.md.us>





**Appendix**

**A**

**Landscaping Guidance for Stormwater BMPs**

## **Introduction**

Landscaping is a critical element to improve both the function and appearance of stormwater best management practices (BMPs). This Appendix provides landscaping criteria and plant selection guidance for effective stormwater BMPs. It is organized as follows:

The first section, A.1, outlines general guidance that should be considered when landscaping any stormwater practice. Section A.2 then presents more specific guidance on landscaping criteria and plant selection for individual BMP designs. These include:

- Stormwater ponds and wetlands
- Infiltration and sand filter practices
- Bioretention
- Open Channels
- Filter Strips and Buffers

In Section A.3, key factors in selecting plant material for stormwater landscaping are reviewed, including hardiness zones, physiographic regions, hydrologic zones, and cultural factors. Section A.4 contains a detailed plant list of native woody and herbaceous species that can be used when preparing a stormwater planting plan.

## **Native Species**

This manual encourages the use of native plants in stormwater management facilities. Native plants are defined as those species which evolved naturally to live in this region. Practically speaking, this refers to those species which lived in Maryland before Europeans explored and settled in America. Many introduced species were weeds brought in by accident; others were intentionally introduced and cultivated for use as medicinal herbs, spices, dyes, fiber plants, and ornamentals.

Introduced species can often escape cultivation and begin reproducing in the wild. This is significant ecologically because many introduced species out-compete indigenous species and begin to replace them in the wild. Some introduced species like kudzu, phragmites, and dandelions are invasive, have few predators, and can take over naturally occurring species at an alarming rate. By planting native species in stormwater management facilities, we can protect Maryland's natural heritage and provide a legacy for future generations.

Native species also have distinct genetic advantages over non-native species for planting in Maryland. Because they have evolved to live here naturally, indigenous plants are best suited for our local climate. This translates into greater survivorship when planted and less replacement and maintenance during the life of a stormwater management facility. Both of these attributes provide cost savings for the facility owner.

Finally, people often plant exotic species for their ornamental value. While it is important to have

aesthetic stormwater management facilities for public acceptance and the maintenance of property value, it is not necessary to introduce foreign species for this purpose. Many native species are aesthetically pleasing and can be used as ornamentals. For example, the following species are part of Maryland's natural heritage and provide high aesthetic value throughout the year: rhododendron, pink azalea, red maple, pin oak, sycamore, flowering dogwood, mountain laurel, willow, hemlock, white pine, bald cypress, atlantic cedar, american holly, black-eyed susan, sunflower, lobelia, pickerel weed, marsh hibiscus, and yellow pond lily. When selecting ornamentals for stormwater management facilities, planting preference should be given to native ornamentals. Please refer to the plant list in Section A.4 for a comprehensive list of native species available for stormwater management facility planting.

### **A.1 General Landscaping Guidance for All Stormwater BMPs**

- Trees, shrubs, and/or any type of woody vegetation are not allowed on the embankment.
- Plant trees and shrubs at least 15 feet away from the toe of slope of a dam.
- Trees or shrubs known to have long taproots should not be within the vicinity of the earth dam or subsurface drainage facilities.
- Plant trees and shrubs at least 25 feet away from perforated pipes.
- Plant trees and shrubs at least 25 feet away from a principal spillway structures.
- Provide 15 foot clearance from a non-clogging, low flow orifice.
- Herbaceous embankment plantings should be limited to 10 inches in height.
- Use erosion control mats and fabrics in channels to reduce the potential for erosion.
- Stabilize all emergency spillways with plant material that can withstand strong flows. Root material should be fibrous and substantial but lacking a taproot.
- Sod channels that are not stabilized with erosion control mats.
- Divert flows temporarily from seeded areas until stabilized.
- Check water tolerances of existing plant materials prior to inundation of area.
- Stabilize aquatic and safety benches with emergent wetland plants and wet seed mixes.
- Do not block maintenance access to structures with trees or shrubs.
- To reduce thermal warming, shade inflow and outflow channels as well as southern exposures of ponds.
- Avoid plantings that will require routine or intensive chemical applications (i.e. turf area).
- Have soil tested to determine if there is a need for amendments.
- Native plant species should be specified over exotic or foreign species because they are well adapted to local on-site soil conditions and require little or no additional amendments.
- Decrease the areas where turf is used. Use low maintenance ground cover to absorb run-off.
  
- Plant stream and water buffers with trees, shrubs, ornamental grasses, and herbaceous materials where possible, to stabilize banks and provide shade.

## Appendix A. Landscaping Guidance for Stormwater BMPs..... General Landscaping Guidance

---

- Maintain and frame desirable views. Be careful not to block views at entrances, exits, or difficult road curves. Screen unattractive views into the site. Aesthetics and visual characteristics should be a prime consideration.
- Use plants to prohibit pedestrian access to pools or steeper slopes.
- The designer should carefully consider the long-term vegetation management strategy for the BMP, keeping in mind the “maintenance” legacy for the future owners. Provide a planting surface that can withstand the compaction of vehicles using maintenance access roads. Make sure the facility maintenance agreement includes requirements to ensure vegetation cover in perpetuity.
- If a BMP is likely to receive excessive amounts of deicing salt, salt tolerant plants should be used.
- Provide signage for:
  - ▶ Stormwater Management Areas to help educate the public.
  - ▶ Wildflower areas, when possible, to designate limits of mowing.
- Avoid the overuse of any plant materials.
- Preserve existing natural vegetation when possible.

It is necessary to test the soil in which you are about to plant in order to determine the following:

- pH; whether acid, neutral, or alkaline
- major soil nutrients; Nitrogen, Phosphorus, Potassium
- minerals; such as chelated iron, lime

Have soil samples analyzed by experienced and qualified individuals, such as those at the Agricultural Extension Office, who will explain in writing the results, what they mean, as well as what soil amendments would be required. Certain soil conditions, such as marine clays, can present serious constraints to the growth of plant materials and may require the guidance of qualified professionals. When poor soils can not be amended, seed mixes and plant material must be selected to establish ground cover as quickly as possible.

Areas that recently have been involved in construction can become compacted so that plant roots cannot penetrate the soil. Also seeds will lie on the surface of compacted soils and are often washed away or eaten by birds. For planting success, soils should be loosened to a depth of three to five inches. Hard soils may require disking to a deeper depth. The soil should be loosened regardless of the ground cover. This will improve seed contact with the soil, increase germination rates, and allow the roots to penetrate the soil. For areas to be sodded, disking is necessary so that the roots can penetrate the soil. Providing good growing conditions can prevent poor vegetative cover. This saves money because vegetation will not need to be replanted.

Whenever possible, topsoil should be spread to a depth of four to eight inches and lightly compacted to minimum thickness of four inches. This provides organic matter and important nutrients for the plant material. The use of topsoil allows vegetation to become established faster and roots to penetrate deeper. This ensures quicker and more complete stabilization, making it less likely that the plants will wash out during a heavy storm.

If topsoil has been stockpiled in deep mounds for a long period of time, it is necessary to test the soil for pH as well as microbial activity. If the microbial activity has been destroyed, it is necessary to inoculate the soil after application.

Remember that newly installed plant material requires water in order to recover from the shock of being transplanted. Be sure that some source of water is provided, especially during dry periods. This will reduce plant loss and provide the new plant materials with a chance to establish root growth.

## A.2 Specific Landscaping Criteria for BMP Groups

### A.2.1 Ponds and Wetlands

For planting within a stormwater management facility, it is necessary to determine what hydrologic zones will be created. Hydrologic zones describe the degree to which an area is inundated by water. Plants have differing tolerances to inundation and the six zones described in this section will dictate which plants will survive where. Every facility does not necessarily exhibit all of these zones.

**Table A.1 Hydrologic Zones**

Zone #	Zone Description	Hydrologic Conditions
Zone 1	Deep Water Pool	1-6 foot deep permanent pool
Zone 2	Shallow Water Bench (low marsh)	6 inches to 1 foot deep
Zone 3	Shoreline Fringe (high marsh)	Regularly inundated
Zone 4	Riparian Fringe	Periodically inundated
Zone 5	Floodplain Terrace	Infrequently inundated
Zone 6	Upland Slopes	Seldom or never inundated

**Zone 1: Deep Water Area (*1 to 6 feet*)**

Ponds and wetlands both have deep pool areas that comprise Zone 1. These pools range from one to six feet in depth, and are best colonized by submergent plants, if at all. This pondscaping zone has not been routinely planted for several reasons. First, the availability of plant materials that can survive and grow in this zone is limited, and it is also feared that plants could clog the stormwater facility outlet structure. In many cases, these plants will gradually become established through natural recolonization (e.g., transport of plant fragments from other ponds by waterfowl). If submerged plant material becomes more commercially available and clogging concerns are addressed, this area can be planted. The function of the planting is to reduce sedimentation and improve oxidation while creating a greater aquatic habitat.

- Plant material must be able to withstand constant inundation of water of one foot or greater in depth.
- Plants may be submerged partially or entirely.
- Plants should be able to enhance pollutant uptake.
- Plants may provide food and cover for waterfowl, desirable insects, and other aquatic life.

Some suggested emergent or submergent species include, but are not limited to lotus, wild celery, and redhead grass.

**Zone 2: Shallow Water Bench/Low Marsh (*6 inches to 1 foot*)**

Zone 2 includes all areas that are inundated below the normal pool to a depth of one foot, and is the primary area where emergent plants will grow in stormwater wetlands. Zone 2 also coincides with the aquatic bench found in stormwater ponds. This zone offers ideal conditions for the growth of many emergent wetland species. These areas may be located at the edge of the pond or on low mounds of earth located below the surface of the water within the pond. When planted, Zone 2 can be an important habitat for many aquatic and nonaquatic animals, creating a diverse food chain. This food chain includes predators, allowing a natural regulation of mosquito populations, thereby reducing the need for insecticide applications.

- Plant material must be able to withstand constant inundation of water to depths between six inches and one foot deep.
- Plants will be partially submerged.
- Plants should be able to enhance pollutant uptake.
- Plants may provide food and cover for waterfowl, desirable insects and other aquatic life.

Plants will stabilize the bottom of the pond, as well as the edge of the pond, absorbing wave impacts and reducing erosion, when water level fluctuates. In addition to slowing water velocities and increasing sediment deposition rates, plants can also reduce resuspension of sediments caused



by the wind. Plants can also soften the engineered contours of the pond, and can conceal drawdowns during dry weather.

Some suggested species for Zone 2 include lobelia, bayberry, many asters, turtlehead, pond cypress, iris, and blue flag. It is important to recognize that a plant typically found in wetlands may be cultivated in nonwetland conditions. Hence the importance of obtaining plant stock which is cultivated in similar hydrologic and soil conditions as those present in the stormwater management facility. A plant typically found in wetlands, but cultivated in nonwetland conditions, may not survive if installed in wetland conditions. A nonwetland plant cultivated in wetland conditions should thrive when introduced to wetland conditions.

**Table A.2 Common Emergent Wetland Plant Species Used for Stormwater Wetlands and on Aquatic Benches of Stormwater Ponds**

Common Name	Scientific Name	Inundation Tolerance
Arrow Arum	<i>Peltandra virginica</i>	up to 12 inches
Arrowhead/Duck Potato	<i>Sagittaria latifolia</i>	up to 12 inches
Broomsedge	<i>Andropogon virginicus</i>	up to 3 inches
Broad Water Weed	<i>Elodea canadensis</i>	at least 12 inches
Bushy Beardgrass	<i>Andropogon glomeratus</i>	up to 12 inches
Common Three-square	<i>Scirpus pungens</i>	up to 6 inches
Marsh Hibiscus	<i>Hibiscus moscheutos</i>	up to 3 inches
Spatterdock	<i>Nuphar luteum</i>	up to 3 inches
Rice Cutgrass	<i>Leersia oryzoides</i>	up to 3 inches
Sedges	<i>Carex spp.</i>	up to 3 inches
Soft Rush	<i>Juncus effusus</i>	up to 3 inches
Switchgrass	<i>Panicum virgatum</i>	up to 3 inches
<p><i>Note 1:</i> Inundation tolerance is maximum inches below the normal pool; most plants prefer shallower depths than the maximum indicated.</p>		
<p><i>Note 2:</i> for additional plant options, consult the stormwater planting list at the end of this appendix. Other good sources include the 1994 Maryland Standards and Specifications for Soil Erosion and Sediment Control (MDE, 1994), Design of Stormwater Wetland Systems (Schueler, 1992) and Planting Guide for the Northeastern United States (Environmental Concern, 1993).</p>		

**Zone 3: Shoreline Fringe/High Marsh (*regularly inundated*)**

Zone 3 encompasses the shoreline of a pond or wetland, and extends vertically about one foot in elevation from the normal pool. This zone includes the safety bench of a pond, and may also be periodically inundated if storm events are subject to extended detention. This zone occurs in a wet pond or shallow marsh and can be the most difficult to establish since plants must be able to withstand inundation of water during storms, when wind might blow water into the area, or the occasional drought during the summer. In order to stabilize the soil in this zone, Zone 3 must have a vigorous cover.

- Plants should stabilize the shoreline to minimize erosion caused by wave and wind action or water fluctuation.
- Plant material must be able to withstand occasional inundation of water. Plants will be partially submerged at this time.
- Plant material should, whenever possible, shade the shoreline, especially the southern exposure. This will help to reduce water temperature.
- Plants should enhance pollutant uptake.
- Plants may provide food and cover for waterfowl, songbirds, and wildlife. Large plants could also be selected and located to control overpopulation of waterfowl.
- Plants should be located to reduce human access where there are potential hazards, but should not block the maintenance access.
- Plants should have very low maintenance requirements, because they may be difficult or impossible to reach.
- Plants should be resistant to disease and other problems which require chemical applications (since chemical application is not advised in stormwater ponds).
- Native plants are preferred because they are low maintenance and disease resistant.

Many of the emergent wetlands plants outline in Table A.2 also thrive in Zone 3. Some other species that do well include bentgrass, foxtail, panic grass, and hawthorn. If shading is needed along the shoreline, the following tree species are suggested— river birch, ash, willow, red maple and willow oak.

**Zone 4: Riparian Fringe (*periodically inundated*)**

Zone 4 extends from one to four feet in elevation above the normal pool. Plants in this zone are subject to periodic inundation after storms, and may experience saturated or partly saturated soil. Nearly all of the temporary ED area is included within this zone.

- Plants must be able to withstand periodic inundation of water after storms, as well as occasional drought during the warm summer months.
- Plants should stabilize the ground from erosion caused by run-off.

- Plants should shade the low flow channel to reduce pool warming whenever possible.
- Plants should enhance pollutant uptake.
- Plant material should have very low maintenance, since they may be difficult or impossible to access.
- Plants may provide food and cover for waterfowl, songbirds and wildlife. Plants may also be selected and located to control overpopulation of waterfowl.
- Plants should be located to reduce pedestrian access to the deeper pools.
- Native plants are preferred because they are low maintenance and disease resistant.

Some frequently used plant species in Zone 4 include coneflower, violets, primrose, milkwort, nannyberry, lespedeza, lilies, flatsedge, hollies, horsythia, lovegrass, hawthorn, spiraea, birch, and sugar maple.

**Zone 5: Floodplain Terrace (*infrequently inundated*)**

Zone 5 is periodically inundated by floodwaters that quickly recede in a day or less. Operationally, Zone 5 extends from the maximum two year or  $C_p$  water surface elevation up to the 10 or 100 year maximum water surface elevation. Key landscaping objectives for Zone 5 are to stabilize the steep slopes characteristic of this zone and establish low maintenance natural vegetation.

- Plant material should be able to withstand occasional but brief inundation during storms. In between storms, typical moisture conditions may be moist, slightly wet, or even swing entirely to drought conditions during the dry weather periods.
- Plants should stabilize the basin slopes from erosion.
- Ground cover should be very low maintenance, since they may be difficult to access on steep slopes or if frequency of mowing is limited. A dense tree cover may help reduce maintenance and discourage resident geese.
- Plants may provide food and cover for waterfowl, songbirds, and wildlife.
- Placement of plant material in Zone 5 is often critical, as it often creates a visual focal point and provides structure and shade for a greater variety of plants.

Some commonly planted species in Zone 5 include solomon's seal, nannyberry, many fescues, many viburnums, cherries, chestnut oak, post oak, and phlox.

**Zone 6: Upland Slopes/Pond Buffer (*seldom or never inundated*)**

The last zone extends above the maximum 100 year water surface elevation, and often includes the outer buffer of a pond or wetland. Unlike other zones, this upland area may have sidewalks, bike paths, retaining walls, and maintenance access roads. Care should be taken to locate plants so they will not overgrow these routes or create hiding places that might make the area unsafe.

- Plant selections should be made based on soil condition, light, and function within the landscape because little or no water inundation will occur.
- Ground covers should require infrequent mowing to reduce the cost of maintaining

this landscape.

- Placement of plants in Zone 6 is important since they are often used to create a visual focal point, frame a desirable view, screen undesirable views, serve as a buffer, or provide shade to allow a greater variety of plant materials. Particular attention should be paid to seasonal color and texture of these plantings.

Some frequently used plant species in Zone 6 include eastern cottonwood, american yew, linden, bald cypress, magnolia, and mountain ash.

**Figure A.1 Hydrologic Zones Around Stormwater Facilities – Legend**

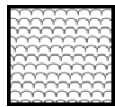

12"-36" depth below normal pool elevation  
Water Lily, Deep Water Duck Potato, Sago Pond Plant, Wild Celery, Redhead Grass

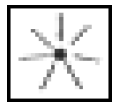

0"-12" depth below normal pool elevation  
Blue Flag Iris, Duck Potato, Flowering Bulrush, Softrush, Sedges, Lobelia, Pond Cypress, various asters



0" to 12" elevation above normal pool elevation  
New England Aster, Marsh Aster, Marsh Marigold (Appalachian Plateau), Tussock Sedge, Spotted Joe Pye Weed, Forget Me Nots, Inkberry, Purple Osier Dogwood, Pin Oak, River Birch, Sycamore, Swamp White Oak (Coastal Plain), Weeping Willow, Dawn Redwood

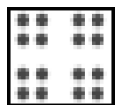

1' to 4' elevation above normal pool elevation  
Purple Cone Flower, Birds Foot Trefoil, Slender Rush, Deer Tongue Grass, Lespedeza, Switch Grass, Serviceberry, Gray Birch, Hackberry, Sweet Pepper Bush (Coastal Plain, Gray stem Dogwood, Red Osier Dogwood, Green Ash,

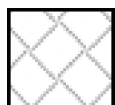

$Q_{p2}$  or  $C_{p_v}$  to  $Q_{p10}$  or  $Q_f$  water surface elevation  
(Many Wildflowers and native grasses) American Holly, Witch Hazel, Ninebark, Red Oak, American Elderberry, American Hemlock, Lowbush Blueberrv. Maple Leaf Viburnum. Nannvberrv. Blackhaw Viburnum



$Q_f$  water surface elevation and above (Floodplain)  
Mostly ornamentals as long as soils drains well. Many natives. All species must be able to tolerate flood plain conditions. Hackberry, Pitch Pine, Sheep Fescue, Wildflowers, many Native Grasses.

Figure A.2 Hydrologic Zones Around Stormwater Facilities

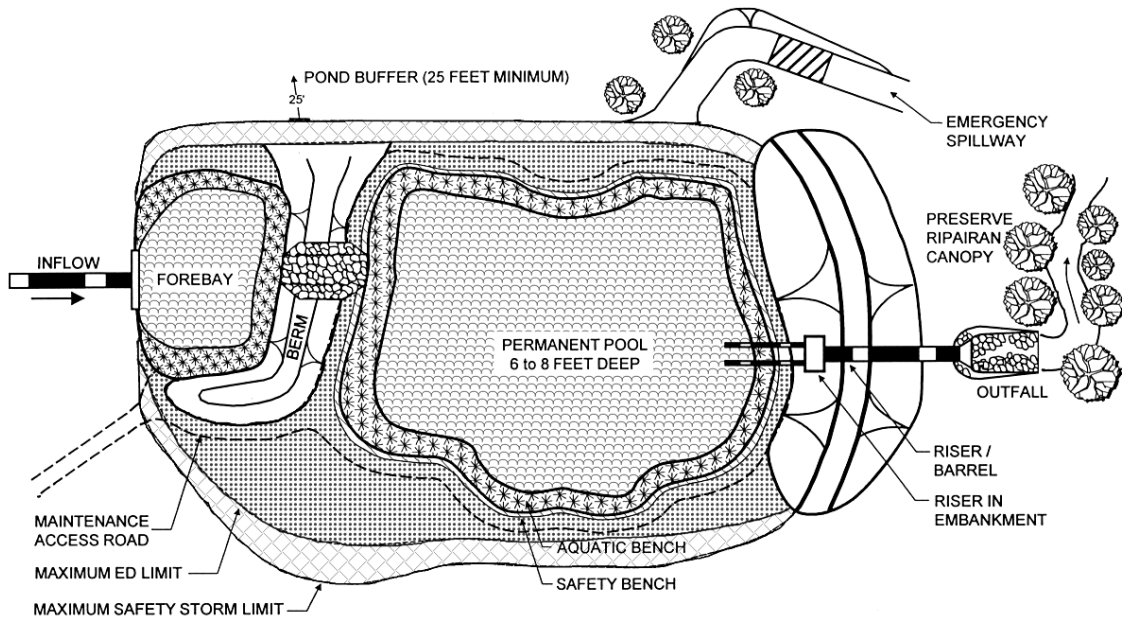

WET ED POND (P-3)

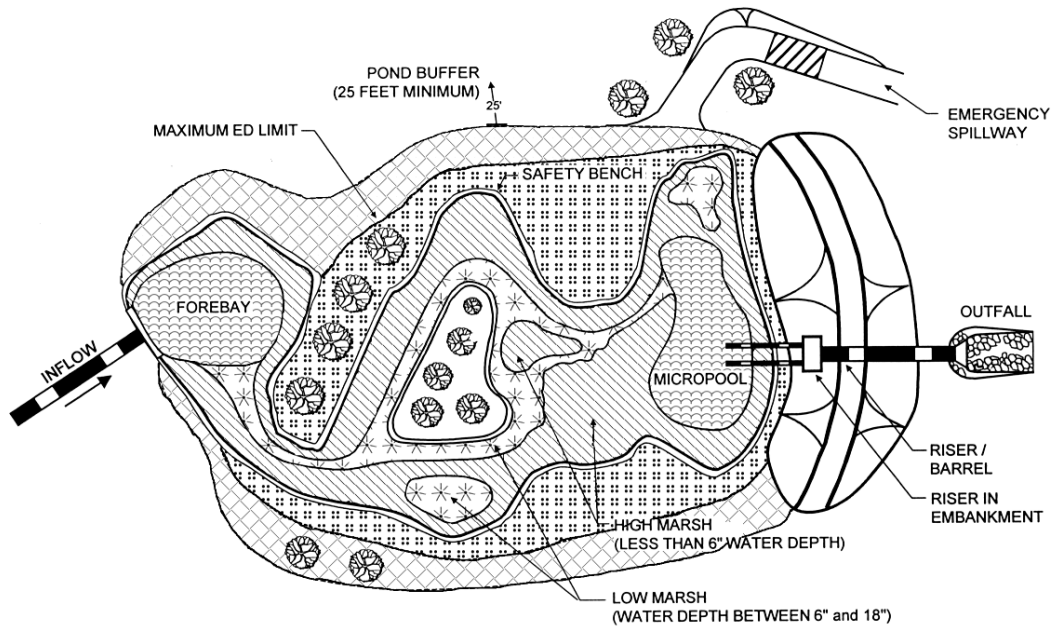

ED SHALLOW WETLAND (W-2)

Figure A.3 Section of Typical Stormwater Management Detention Pond

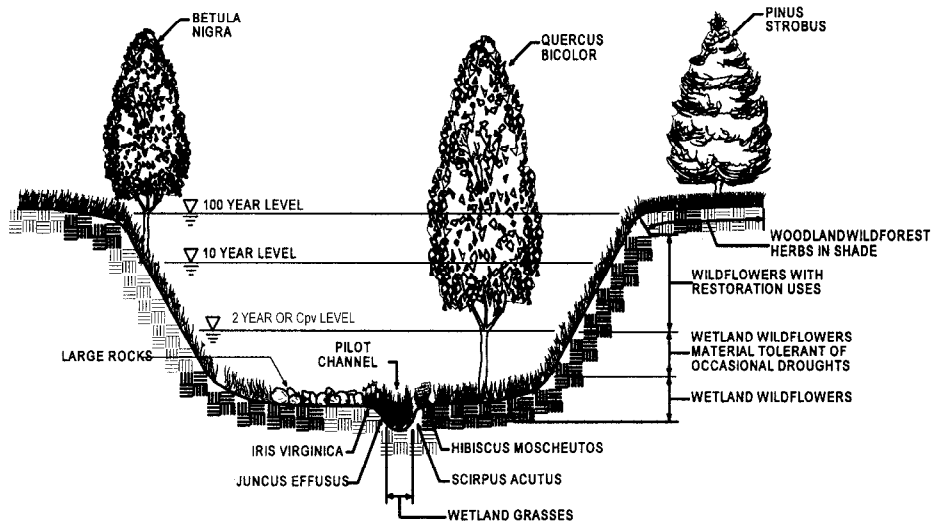
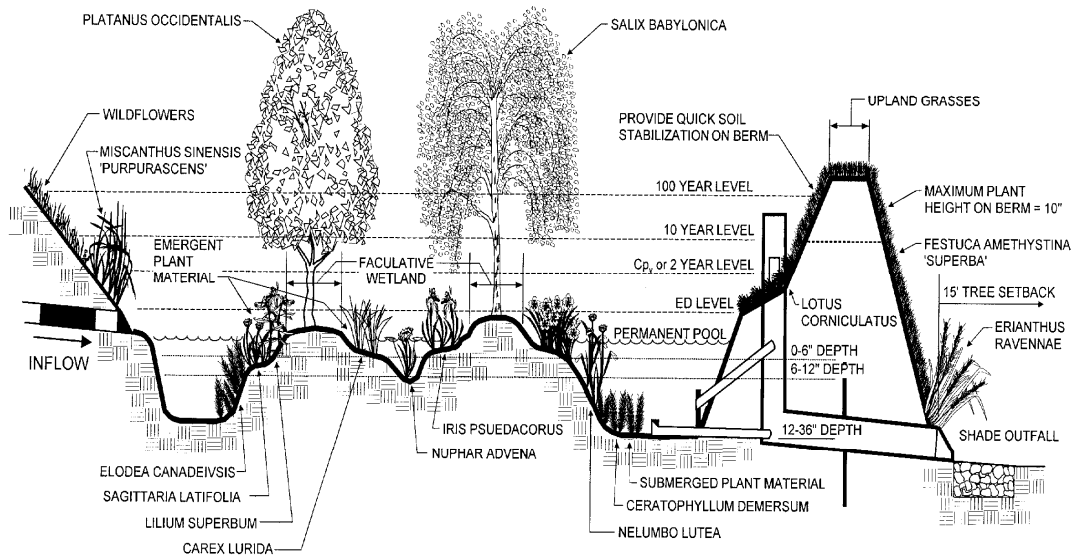

Figure A.4 Section of Typical Shallow Extended Detention Wetland System



## **A.2.2 Infiltration and Filter Systems**

Infiltration and filter systems either take advantage of existing permeable soils or create a permeable medium such as sand for  $WQ_v$  and  $Re_v$ . In some instances where permeability is great, these facilities may be used for  $Q_p$  as well. The most common systems include infiltration trenches, infiltration basins, sand filters, and organic filters.

When properly planted, vegetation will thrive and enhance the functioning of these systems. For example, pre-treatment buffers will trap sediments that often are bound with phosphorous and metals. Vegetation planted in the facility will aid in nutrient uptake and water storage. Additionally, plant roots will provide arteries for stormwater to permeate soil for groundwater recharge. Finally, successful plantings provide aesthetic value and wildlife habitat making these facilities more desirable to the public.

### **Design Constraints:**

- Planting buffer strips of at least 20 feet will cause sediments to settle out before reaching the facility, thereby reducing the possibility of clogging.
- Determine areas that will be saturated with water and water table depth so that appropriate plants may be selected (hydrology will be similar to bioretention facilities, see figure A.5 and Table A.4 for planting material guidance).
- Plants known to send down deep taproots should be avoided in systems where filter fabric is used as part of facility design.
- Test soil conditions to determine if soil amendments are necessary.
- Plants shall be located so that access is possible for structure maintenance.
- Stabilize heavy flow areas with erosion control mats or sod.
- Temporarily divert flows from seeded areas until vegetation is established.
- See Table A.5 for additional design considerations.

## **A.2.3 Bioretention**

### **Soil Bed Characteristics**

The characteristics of the soil for the bioretention facility are perhaps as important as the facility location, size, and treatment volume. The soil must be permeable enough to allow runoff to filter through the media, while having characteristics suitable to promote and sustain a robust vegetative cover crop. In addition, much of the nutrient pollutant uptake (nitrogen and phosphorus) is accomplished through absorption and microbial activity within the soil profile. Therefore, soils must balance their chemical and physical properties to support biotic communities above and below ground.

The planting soil should be a sandy loam, loamy sand, loam (USDA), or a loam/sand mix (should contain a minimum 35 to 60% sand, by volume). The clay content for these soils should be less than 25% by volume [Environmental Quality Resources (EQR), 1996; Engineering Technology Inc. and Biohabitats, Inc. (ETAB), 1993]. Soils should fall within the SM, ML, SC classifications or the Unified Soil Classification System (USCS). A permeability of at least 1.0 feet per day (0.5"/hr) is required (a conservative value of 0.5 feet per day is used for design). The soil should be free of stones, stumps, roots, or other woody material over 1" in diameter. Brush or seeds from noxious weeds (e.g., Johnson Grass, Mugwort, Nutsedge, and Canada Thistle or other noxious weeds as specified under COMAR 15.08.01.05.) should not be present in the soils. Placement of the planting soil should be in 12" to 18" lifts that are loosely compacted (tamped lightly with a backhoe bucket or traversed by dozer tracks). The specific characteristics are presented in Table A.3.

**Table A.3 Planting Soil Characteristics**  
(Adapted from EQR, 1996; ETAB, 1993)

<b>Parameter</b>	<b>Value</b>
pH range	5.2 to 7.00
Organic matter	1.5 to 4.0% (by weight)
Magnesium	35 lbs. per acre, minimum
Phosphorus (phosphate - P <sub>2</sub> O <sub>5</sub> )	75 lbs. per acre, minimum
Potassium (potash - K <sub>2</sub> O)	85 lbs. per acre, minimum
Soluble salts	500 ppm
Clay	10 to 25%
Silt	30 to 55%
Sand	35 to 60%

**Mulch Layer**

The mulch layer plays an important role in the performance of the bioretention system. The mulch layer helps maintain soil moisture and avoids surface sealing which reduces permeability. Mulch helps prevent erosion, and provides a microenvironment suitable for soil biota at the mulch/soil interface. It also serves as a pretreatment layer, trapping the finer sediments which remain suspended after the primary pretreatment.

The mulch layer should be standard landscape style, single or double shredded hardwood mulch or



chips. The mulch layer should be well aged (stockpiled or stored for at least 12 months), uniform in color, and free of other materials, such as weed seeds, soil, roots, etc. The mulch should be applied to a maximum depth of three inches. Grass clippings should not be used as a mulch material.

### **Planting Guidance**

Plant material selection should be based on the goal of simulating a terrestrial forested community of native species. Bioretention simulates an upland-species ecosystem. The community should be dominated by trees, but have a distinct community of understory trees, shrubs and herbaceous materials. By creating a diverse, dense plant cover, a bioretention facility will be able to treat stormwater runoff and withstand urban stresses from insects, disease, drought, temperature, wind, and exposure.

The proper selection and installation of plant materials is key to a successful system. There are essentially three zones within a bioretention facility (Figure A.5). The lowest elevation supports plant species adapted to standing and fluctuating water levels. The middle elevation supports plants that like drier soil conditions, but can still tolerate occasional inundation by water. The outer edge is the highest elevation and generally supports plants adapted to dryer conditions. A sample of appropriate plant materials for bioretention facilities are included in Table A.4. The layout of plant material should be flexible, but should follow the general principals described in Table A.5. The objective is to have a system which resembles a random and natural plant layout, while maintaining optimal conditions for plant establishment and growth. For a more extensive bioretention plan, consult ETA&B, 1993 or Claytor and Schueler, 1997.

**Figure A.5 Planting Zones for a Bioretention Facilities**

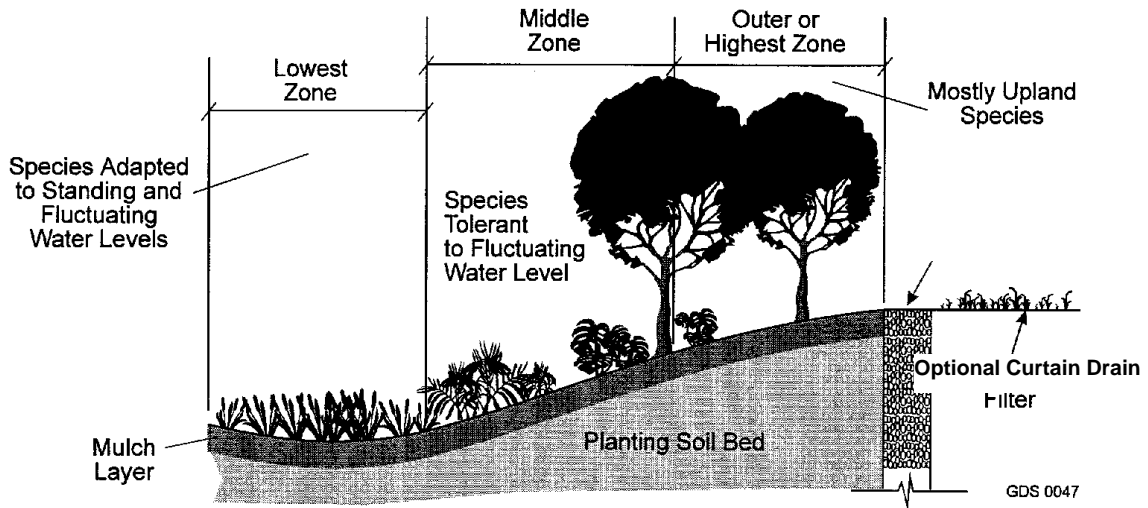

**Table A.4 Commonly Used Species for Bioretention Areas**

<b>Trees</b>	<b>Shrubs</b>	<b>Herbaceous Species</b>
<i>Acer rubrum</i> Red Maple	<i>Aesculus parviflora</i> Bottlebrush Buckeye	<i>Andropogon virginicus</i> Broomsedge
<i>Betula nigra</i> River Birch	<i>Cephalanthus occidentalis</i> Buttonbush	<i>Eupatorium perpurea</i> Joe Pye Weed
<i>Juniperus virginiana</i> Eastern Red Cedar	<i>Hamamelis virginiana</i> Witch Hazel	<i>Scirpus pungens</i> Three Square Bulrush
<i>Chionanthus virginicus</i> Fringe-tree	<i>Vaccinium corymbosum</i> Highbush Blueberry	<i>Iris versicolor</i> Blue Flag
<i>Nyssa sylvatica</i> Black Gum	<i>Ilex glabra</i> Inkberry	<i>Lobelia cardinalis</i> Cardinal Flower
<i>Diospyros virginiana</i> Persimmon	<i>Ilex verticillata</i> Winterberry	<i>Panicum virgatum</i> Switchgrass
<i>Platanus occidentalis</i> Sycamore	<i>Viburnum dentatum</i> Arrowwood	<i>Dichanthelium scoparium</i> Broom Panic Grass
<i>Quercus palustris</i> Pin Oak	<i>Lindera benzoin</i> Spicebush	<i>Rudbeckia laciniata</i> Tall Coneflower
<i>Quercus phellos</i> Willow Oak	<i>Myrica pennsylvanica</i> Bayberry	<i>Scirpus cyperinus</i> Woolgrass
<i>Salix nigra</i> Black willow		<i>Vernonia noveboracensis</i> New York Ironweed
<p>Note 1: For more options on plant selection for bioretention, consult Bioretention Manual (ETAB, 1993) or the Design of Stormwater Filtering Systems (Claytor and Schueler, 1997).</p>		

**Table A.5 Planting Plan Design Considerations**

- Native plant species should be specified over exotic or foreign species.
- Appropriate vegetation should be selected based on the zone of hydric tolerance.
- Species layout should generally be random and natural.
- A canopy should be established with an understory of shrubs and herbaceous materials.
- Woody vegetation should not be specified in the vicinity of inflow locations.
- Trees should be planted primarily along the perimeter of the bioretention area.
- Stressors (e.g., wind, sun, exposure, insect and disease infestation, and drought) should be considered when laying out the planting plan.
- Noxious weeds shall not be specified or used.
- Aesthetics and visual characteristics should be a prime consideration.
- Traffic and safety issues must be considered.
- Existing and proposed utilities must be identified and considered.

### **Plant Material Guidance**

Plant materials should conform to the American Association of Nurserymen’s publication, the American Standard Nursery Stock. The planting plan shall include a sequence of construction; a description of the contractor's responsibilities; a planting schedule and installation specifications; initial maintenance requirements; and a warranty period stipulating requirements for plant survival. Table A.6 presents some typical issues for planting specifications.

**Table A.6 Planting Specification Issues**

Specification Element	Elements
Sequence of Construction	Describe site preparation activities, soil amendments, etc.; address erosion and sediment control procedures; specify step-by-step procedure for plant installation through site clean-up.
Contractor's Responsibilities	Specify the contractor's responsibilities, such as watering, care of plant material during transport, timeliness of installation, repairs due to vandalism, etc.
Planting Schedule and Specifications	Specify the plants to be installed, the type of materials (e.g., balled and burlap, bare root, containerized); time of year of installations, sequence of installation of types of plants; fertilization, stabilization seeding, if required; watering and general care.
Maintenance	Specify inspection periods; mulching frequency (annual mulching is most common); removal and replacement of dead and diseased vegetation; treatment of diseased trees; watering schedule after initial installation (once per day for 14 days is common); repair and replacement of staking and wires.
Warranty	Specify the warranty period, the required survival rate, and expected condition of plant species at the end of the warranty period.

**A.2.4 Open Channels**

Consult Table A.7 for grass species that perform well in the stressful environment of an open channel. For more detailed information, please consult the 1994 Maryland Standards and Specifications for Soil Erosion and Sediment Control. If a BMP is likely to receive excessive amounts of deicing salt, salt tolerant plants should be used.

**A.2.5 Filter Strips and Stream Buffer**

For design and plant selection of filter strips and stream buffers, please consult the USDA Natural Resources Conservation Service Maryland Conservation Practice Standard No. 391 “Riparian Stream Buffers.”

**Table A.7 Common Grass Species for Open Channels**

Common Name	Scientific Name	Notes
Big Bluestem	<i>Andropogon gerardii</i>	Warm, not for Wet Swale
Creeping Bentgrass	<i>Agrostis palustris</i>	Cool,
Red Fescue	<i>Festuca rubra</i>	Cool, not for Wet Swale
Reed Canary grass	<i>Phalaris arundinacea</i>	Cool, Wet Swale
Redtop	<i>Agrostis alba</i>	Cool,
Smooth Brome	<i>Bromus inermis</i>	Cool, not for Wet Swale
Switch grass	<i>Panicum virgatum</i>	Warm
<p><i>Note 1:</i> These grasses are sod-forming and can withstand frequent inundation, and are thus ideal for the swale or grass channel environment. Most are salt-tolerant, as well. Cool refers to cool season grasses that do well in the western part of the State, Warm refers to warm season grasses that work well in the eastern part of the State (see Table A.8).</p> <p><i>Note 2:</i> Where possible, one or more of these grasses should be in the seed mixes. For a more thorough listing of seed mixes, consult the 1994 Maryland Standard and Specifications for Soil Erosion and Sediment Control (MDE, 1994) or the MD NRCS Code 391 Riparian Forest Buffer Standard, Table 2 (Zone 3).</p>		

### A.3 Plant Selection for Stormwater Facilities

#### A.3.1 Hardiness Zones

Hardiness zones are based on historical annual minimum temperatures recorded in an area. A BMP's location in relation to plant hardiness zones is important to consider first because plants differ in their ability to withstand very cold winters. This does not imply that plants are not affected by summer temperatures. Given that Maryland summers can be very hot, heat tolerance is also a characteristic that should be considered in plant selection.

**Table A.8 Average Annual Minimum Temperature**

Zone		USDA Minimum Temperature (°F)
Temperate Zone 1		below -50°
Temperate Zone 2		-50° to -40°
Temperate Zone 3		-40° to -30°
Temperate Zone 4		-30° to -20°
Temperate Zone 5	a	-20° to -15°
	b	-15° to -10°
Temperate Zone 6	a	-10° to -5°
	b	-5° to 0°
Temperate Zone 7	a	0° to 5°
	b	5° to 10°
Temperate Zone 8		10° to 20°

It is best to recommend plants known to thrive in specific hardiness zones. The plant list included at the end of this appendix identifies the hardiness zones for each species listed as a general planting guide. It should be noted, however, that certain site factors can create microclimates or environmental conditions which permit the growth of plants not listed as hardy for that zone. By investigating numerous references and based on personal experience, a designer should be able to confidently recommend plants that will survive in microclimates.

**Figure A.6 USDA Plant Hardiness Zones in Maryland**

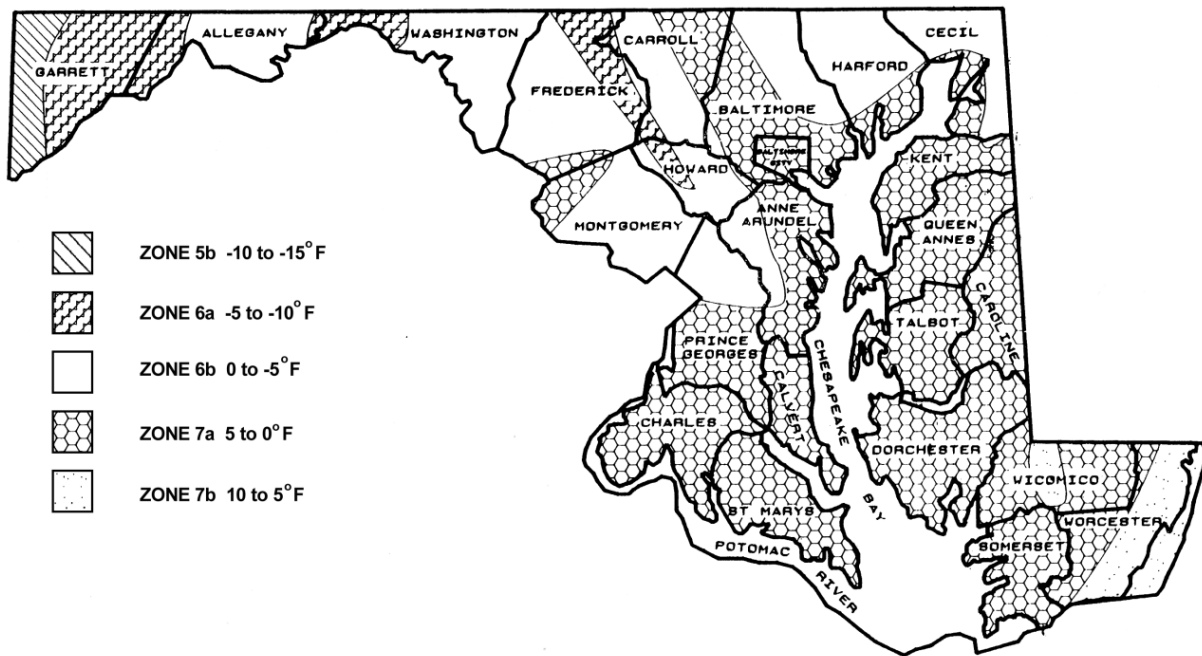

### A.3.2 Physiographic Provinces

There are five physiographic provinces in Maryland that describe distinct geographic regions in the State with similar physical and environmental conditions (Figure A.7). These physiographic provinces include, from west to east, the Appalachian Plateau, Valley and Ridge, Blue Ridge, Piedmont, and Coastal Plain. Each physiographic region is defined by unique geological strata, soil type, drainage patterns, moisture content, temperature and degree of slope which often dictate the predominant vegetation. Because the predominant vegetation has evolved to live in these specific conditions, a successful stormwater management facility planting design can be achieved through mimicking these natural associations. The five physiographic regions are described below with associated vegetation listed as general planting guidance. For more detailed information and plant listings please refer to *Woody Plants of Maryland* (Brown and Brown, 1992).



**Figure A.7** Physiographic Provinces and Forest Types of Maryland

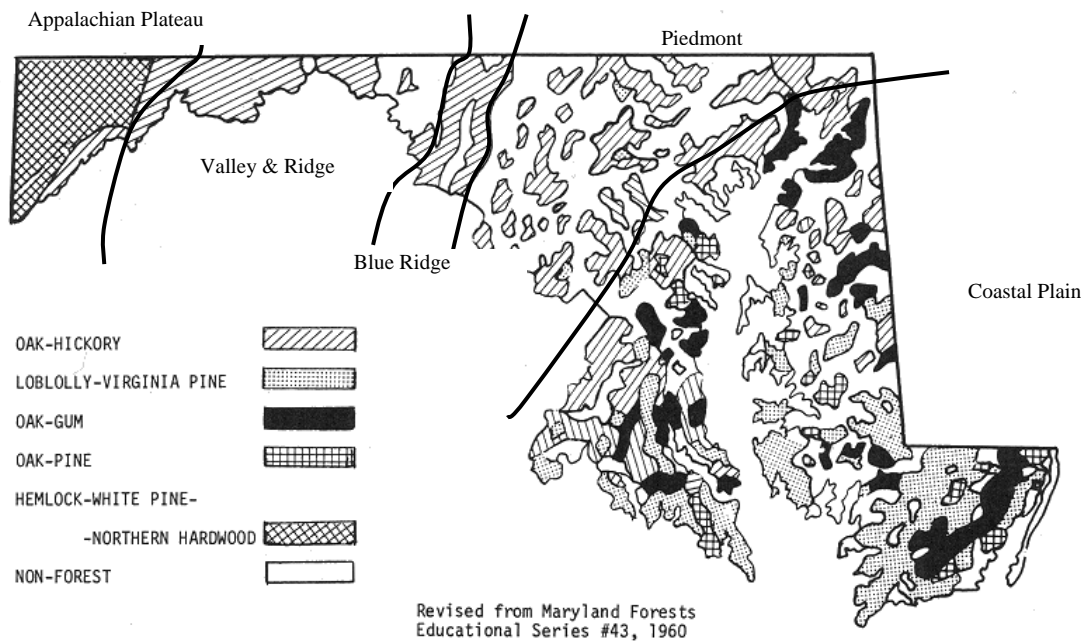

FOREST TYPES OF MARYLAND

**Appalachian Plateau Province**

The Appalachian Plateau Province is where Maryland’s highest elevations occur with Backbone Mountain being the greatest at 3,360 feet above sea level. In the higher elevations of the Appalachian Plateau, the climate becomes similar to that of the northern states and Canada. Slopes in the Appalachian Plateau are often steep and deeply carved by winding streams. This province has mountainous soils composed of clay and clay loams. The predominant forest types in this province are the Northern Hardwood and Oak-Hickory.

Common Species of the Appalachian Plateau Province	
Tree Species	Understory
eastern hemlock, white pine, mountain pine, pitch pine, red spruce, sugar maple, white basswood, american basswood, beech, yellow birch, sweet birch, cucumber tree, tulip tree, white oak, chestnut oak, scarlet oak, red oak, white ash, black walnut, and white walnut	hydrangea, flowering dogwood, pink azaleas, greenbriers, witch hazel, iron wood, hazelnut, blueberries, huckleberries, dewberries, dockmackie, deerberry, great laurel, hobble bush, mountain maple, striped maple, red-berried elder, bush honeysuckle, canadian yew, mountain holly, red raspberry, allegheny menziesia, and dwarf cornel

Within the Appalachian Plateau are bog and swamp areas which support unique vegetation. For stormwater management facilities that will remain wet year-round, many species found in these bog and swamp areas will likely do well. Around the edges of these bogs, red spruce, white pine, hemlock, black gum, red maple, large and small toothed aspen, and pussy willow are common. Interior bog species include tamarack or larch, alders, swamp rose, winter berry, wild raisin, arrowwood, mountain holly, great laurel, smooth service berry, high bush blueberry, swamp dewberries, and cranberries.

**Valley and Ridge, Blue Ridge, and Piedmont Provinces**

The Valley and Ridge Province is where parallel ridges and valleys of the Appalachian Mountains create an alternating pattern. This province has mountainous soils composed of clay and clay loams, as well as sandy or stony loams. Often, the soils are shallow, and shale barrens may be found. The climate is dry. Most of the precipitation from the west is blocked by the Allegheny Mountain range, and precipitation from the east is blocked by the Blue Ridge Mountains.

The Blue Ridge Province is on the eastern edge of the Appalachian Mountains. This province has mountainous soils composed of sandy or stony loams. The climate is similar to that in the Piedmont Province, but somewhat cooler and moister.

The Piedmont Province is an area of rolling uplands with elevations ranging from 100 to 500 feet above sea level. Soils of the Piedmont are derived from granite rock and consist of loams and clays with rock fragments and gravel. The climate is moderate throughout this central Maryland province.

<b>Common Species of the Valley and Ridge, Blue Ridge, and Piedmont Provinces</b>	
<b>Tree Species</b>	<b>Understory</b>
hickory, chestnut oak, scarlet oak, scrub oak, white oak, red oak, black oak, scrub pine, pitch pine, short leaf pine, white pine, hemlocks, beech, black jack oak, shingle oak, fringe tree, and chinquapin	Sweet fern, flowering dogwood, black haw, chinquapin, sassafras, redbud, mountain laurel, blueberry, fringe tree, pink azalea, hydrangea, spicebush, and maple-leaved arrowwood

In the Hagerstown region of the Ridge and Valley Province, limestone outcrops produce alkaline soils which are conducive to red cedar communities. Other common species include oaks, black locust, redbud, fragrant sumac, hop hornbeam, hackberry, and slippery elm. Between Cumberland and Flintstone a series of shale barrens occur. These areas have a low water holding capacity and surfaces can get hot on sunny days. Common species associated with the shale barrens include scrub pine, scrub oak, post oak, yellow oak, fragrant sumac, dwarf sumac, single-flowered hawthorn, dwarf hackberry, New Jersey tea, Allegheny plum and pasture rose.

**Coastal Plain Province**

The Coastal Plain Province is recognized by flat or gently rolling topography and elevations rising from sea level to about 100 feet. Coastal Plain marshes and swampy tidal flats surround the Chesapeake Bay. Sands, sandy loams, and silt loams make up the soils of the Coastal Plain. The climate is mild and sometimes rainy, similar to that found further south.

<b>Common Species of the Coastal Plain Province</b>	
<b>Forest Species</b>	<b>Understory</b>
loblolly pine, virginia pine, pitch pine, pond pine, sweet gum, willow oak, water oak, basket oak, pin oak, post oak, spanish oak, black cottonwood, pale hickory, bitternut hickory, sweet bay, american holly, beech, tulip tree, and river birch	blueberry, huckleberry, greenbier, sand blackberry, beach plum, beach heather, bay berry, sweet pepper bush, azalea, maleberry, stagger bush, fetter bush, inkberry, and alder

Because of low topographic relief and proximity to sea level, extensive swamp areas are common to the Coastal Plain Province. Most notable are the cypress swamps found on both the Eastern and Western Shores. As with the bogs of the Appalachian Province, species common to Coastal Plain swamps will grow well in wet stormwater management facilities because of the similar hydrology. In addition to bald cypress, other common species to these swamps are southern white cedar, black gum, red maple, and swamp bay. Common understory include evergreen laurel-leaved greenbrier, red-berried greenbrier, red choke berry, swamp haw, smooth winterberry, virginia willow, bay berry, inkberry, and swamp rose.

**Floodplain Regions in Maryland**

Floodplains occur across Maryland’s physiographic provinces as low-lying areas adjacent to streams and rivers. Floodplain plant communities are similar across most of the State because of common soil characteristics governed by occasional flooding and high groundwater. Because stormwater management facilities are often located in floodplains, plant associations in these areas can provide valuable information for successful BMP plantings.

<b>Common Species of Floodplain Regions</b>	
<b>Forest Species</b>	<b>Understory</b>
river birch, willows, silver maple, sweet gum, sycamore, box elder, green ash, american elm, swamp white oak, bur oak, honeylocust, and hackberry	shrub willows, ninebark, silkey cornel, buttonbush, spicebush, black alder, winterberry, black elderberry, and alders

### A.3.3 Hydrologic Zones

For planting within a stormwater management facility, it is necessary to determine what hydrologic zones will be created. Hydrologic zones describe the degree to which an area is inundated by water. Plants have differing tolerances to inundation and as an aid to landscape designers, these tolerance levels have been divided into six zones and corresponding plant species have been identified.

Section A.4 includes a native plant list with appropriate hydrologic zones designated for each species. The hydrologic zones which are bracketed [ ] are where the plants tend to occur. There may be other zones listed outside of these brackets. The plants may occur in these zones, but are not typically found in them. Just as plants may, on occasion, be found outside of their hardiness zone, they may also be found outside of their hydrologic zone. They tend to grow where they can compete and survive. Additionally, hydrologic conditions in a stormwater management facility may fluctuate in unpredictable ways; thus the use of plants capable of tolerating wide varieties of hydrologic conditions greatly increases a successful planting. Conversely, plants suited for specific hydrologic conditions may perish when hydrologic conditions fluctuate, expose the soil, and increase the chance for erosion.

**Table A.9** Hydrologic Zones

<b>Zone #</b>	<b>Zone Description</b>	<b>Hydrologic Conditions</b>
Zone 1	Deep Water Pool	1-6 foot deep permanent pool
Zone 2	Shallow Water Bench (low marsh)	6 inches to 1 foot deep
Zone 3	Shoreline Fringe (high marsh)	Regularly inundated
Zone 4	Riparian Fringe	Periodically inundated
Zone 5	Floodplain Terrace	Infrequently inundated
Zone 6	Upland Slopes	Seldom or never inundated

### A.3.4 Other Considerations in Stormwater BMP Landscaping

### **Use or Function**

In selecting plants, consider their desired function in the landscape. Is the plant needed as ground cover, soil stabilizer, or a source of shade? Will the plant be placed to frame a view, create focus, or provide an accent? Does the location require that you provide seasonal interest to neighboring properties? Does the adjacent use provide conflicts or potential problems and require a barrier, screen, or buffer? Nearly every plant and plant location should be provided to serve some function in addition to any aesthetic appeal.

### **Plant Characteristics**

Certain plant characteristics are so obvious, they may actually be overlooked in the plant selection. These are:

- Size
- Shape

For example, tree limbs, after several years, can grow into power lines. A wide growing shrub may block an important line of sight to oncoming vehicular traffic. A small tree, when full grown, could block the view from a second story window. Consider how these characteristics can work for you or against you, today and in the future.

Other plant characteristics must be considered to determine how the plant provides seasonal interest and whether the plant will fit with the landscape today and through the seasons and years to come. Some of these characteristics are:

- Color
- Texture
- Seasonal Interest (e.g., flowers, fruit, leaves, stems/bark)
- Growth Rate

If shade is required in large amounts, quickly, a sycamore might be chosen over an oak. In urban or suburban settings, a plant's seasonal interest may be of greater importance. Residents living next to a stormwater system may desire that the facility be appealing or interesting to look at throughout the year. For example, willows are usually the first trees to grow leaves signaling the coming of spring. Pink and white dogwoods bloom in mid-spring to early summer, while witch hazel has a yellow bloom every fall which can be contrasted with the red fall foliage of a sugar maple. Careful attention to the design and planting of a facility can result in greater public acceptance and increased property value.

### **Availability and Cost**

Often overlooked in plant selection is the availability from wholesalers and the cost of the plant material. There are many plants listed in landscape books that are not readily available from local nurseries. Without knowledge of what is available, time spent researching and finding the one plant that meets all the needs will be wasted. It may require shipping, therefore, making it more costly than the budget may allow. Some planting requirements may require a special effort to find the specific plant that fulfills the needs of the site and the function of the plant in the landscape.

In some cases, it may be cost effective to investigate nursery suppliers for the availability of wetland seed mixtures. Specifications of the seed mix shall include wetland seed types and the relative proportion of each species. Some suppliers provide seed mixtures suitable for specific wetland, upland, or riparian habitat conditions. This option may best be employed in small stormwater facilities such as pocket wetlands and open swales, or to complement woody vegetation plantings in larger facilities.

#### **A.4 Stormwater Plant List**

The pages at the end of this appendix present a list of herbaceous, tree and shrub plants native to Maryland and suitable for planting in stormwater management facilities. The list is intended as a guide for general planting purposes and planning considerations. Knowledgeable landscape designers and nursery suppliers may provide additional information for considering specific conditions for successful plant establishment and accounting for the variable nature of stormwater hydrology.

The planting list is in alphabetical order according to the common name, with the scientific name also provided. Life forms indicate whether a plant species is an “annual,” “perennial,” “grass,” “fern,” “shrub,” or “tree”.

Each plant species has a corresponding hydrologic zone provided to indicate the most suitable planting location for successful establishment. While the most common zones for planting are listed in parenthesis, the listing of additional zones indicates that a plant may survive over a broad range of hydrologic conditions.

The wetland indicator status (from Region 1, Reed, 1988) has been included to show “the estimated probability of a species occurring in wetlands versus nonwetlands” (Reed, 1988). Reed defines the indicator categories as follows:

Obligate wetland (OBL): Plants, which nearly always (more than 99% of the time) occur in wetlands under natural conditions.

Facultative Wetland (FACW): Plants, which usually occur in wetlands (from 67 to 99% of the time), but occasionally found in non wetlands.

Facultative (FAC): Plants, which are equally likely to occur in wetlands and non wetlands and are found in wetlands from 34 to 66% of the time.

Facultative Upland (FACU): Plants, which usually occur in non wetlands (from 67 to 99% of the time), but occasionally found in wetlands (from 1 to 33% of the time).

Upland (UPL): Plants, which almost always (more than 99% of the time) under natural conditions occur in non wetlands.

A given indicator status shown with a “+” or a “-“ means that the species is more (+) or less (-) often found in wetlands than other plants with the same indicator status without the “+” or “-“ designation.

Since the wetland indicator status alone does not provide an indication of the depth or duration of flooding that a plant will tolerate, the “Inundation Tolerance” section is designed to provide further guidance. Where a plant species is capable of surviving in standing water, a “yes” is designated in this column. Additional information is provided for depth of inundation for aquatic vegetation and tolerance for seasonal inundation or saturated soil conditions. Because individual plants often have unique life requirements difficult to convey in a general listing, it will be necessary to research specific information on the plant species proposed in order to ensure successful plant establishment.

Pollution tolerance and salt tolerance information are indicated to identify plantings that would be most appropriate in pollution hot spots.

Hardiness zones are provided for the U.S.D.A. hardiness zones. The herbaceous plant list identifies the range of zones the plant may survive in, while the tree and shrub list shows the coldest zone where the plant may naturally occur.

**Table A.4.1 Stormwater Plant List - Woody Vegetation**

COMMON	SCIENTIFIC	FORM	ZONE	INDICATOR	TOLERANCE			HARDINESS
					INUNDATION	POLLUTION	SALT	
ALDER,BROOK-SIDE	<i>Alnus serrulata</i>	Tree	[1,2],3	OBL	0-3"	<input type="checkbox"/>	<input type="checkbox"/>	
ALDER,SEASIDE	<i>Alnus maritima</i>	Tree	[1,2],3	OBL	YES	<input type="checkbox"/>	<input type="checkbox"/>	
ALDER,SPECKLED	<i>Alnus rugosa</i>	Tree	1[2,3]	FACW+	YES	<input type="checkbox"/>	<input type="checkbox"/>	2
ARROW-WOOD	<i>Viburnum dentatum</i>	Shrub	[3,4],5	FAC	SEASONAL	<input type="checkbox"/>	<input checked="" type="checkbox"/>	2
ASH,BLACK	<i>Fraxinus nigra</i>	Tree	[2,3],4	FACW	SATURATED	<input type="checkbox"/>	<input type="checkbox"/>	2
ASH,GREEN	<i>Fraxinus pennsylvanica</i>	Tree	[2,3],4	FACW	SEASONAL	<input type="checkbox"/>	<input checked="" type="checkbox"/>	2
ASH,WHITE	<i>Fraxinus americana</i>	Tree	[4,5],6	FACU	NO	<input type="checkbox"/>	<input type="checkbox"/>	3
ASPEN,BIG-TOOTH	<i>Populus grandidentata</i>	Tree	[4,5,6]	FACU	NO	<input type="checkbox"/>	<input type="checkbox"/>	3
ASPEN,QUAKING	<i>Populus tremuloides</i>	Tree	[4,5],6	FACU	YES	<input type="checkbox"/>	<input type="checkbox"/>	1
AZALEA,DWARF	<i>Rhododendron atlanticum</i>	Shrub	[2,3,4],5	FAC,FAC+	YES	<input type="checkbox"/>	<input type="checkbox"/>	
AZALEA,EARLY	<i>Rhododendron prinophyllum</i>	Shrub	[2,3,4],5	FAC,FAC+	YES	<input type="checkbox"/>	<input type="checkbox"/>	3
AZALEA,HOARY	<i>Rhododendron canescens</i>	Shrub	[2,3],4	FACW	YES	<input type="checkbox"/>	<input type="checkbox"/>	
AZALEA,PINK	<i>Rhododendron periclymenoides</i>	Shrub	2,[3,4],5	FAC	SEASONAL	<input type="checkbox"/>	<input type="checkbox"/>	3
AZALEA,SMOOTH	<i>Rhododendron arborescens</i>	Shrub	[3,4],5	FAC	YES	<input type="checkbox"/>	<input type="checkbox"/>	4
AZALEA,SWAMP	<i>Rhododendron viscosum</i>	Shrub	[1,2,3],4	FACW+,OBL	SEASONAL	<input type="checkbox"/>	<input type="checkbox"/>	3
BASSWOOD,AMERICAN	<i>Tilia americana</i>	Tree	3,[4,5],6	FACU	NO	<input type="checkbox"/>	<input type="checkbox"/>	2
BAYBERRY,NORTHERN	<i>Myrica pennsylvanica</i>	Shrub	[3,4],5	FAC	SEASONAL	<input type="checkbox"/>	<input checked="" type="checkbox"/>	2
BAYBERRY,SOUTHERN	<i>Myrica cerifera</i>	Shrub	[2,3,4],5	FAC,FAC+	REG.INUNDA	<input type="checkbox"/>	<input type="checkbox"/>	
BEECH,AMERICAN	<i>Fagus grandifolia</i>	Tree	[4,5],6	FACU	NO	<input type="checkbox"/>	<input type="checkbox"/>	3
BIRCH,GRAY	<i>Betula populifolia</i>	Tree	[3,4],5	FAC	SEASONAL	<input type="checkbox"/>	<input type="checkbox"/>	5
BIRCH,RIVER	<i>Betula nigra</i>	Tree	[2,3],4	FACW	SEASONAL	<input type="checkbox"/>	<input type="checkbox"/>	4
BIRCH,YELLOW	<i>Betula alleghaniensis</i>	Tree	[3,4],5	FAC	YES	<input type="checkbox"/>	<input type="checkbox"/>	3
BLACK GUM, SWAMP TUPELO	<i>Nyssa sylvatica</i>	Tree	1,[2,3]	FACW+	SEASONAL	<input type="checkbox"/>	<input type="checkbox"/>	4

Stormwater Plant List - Woody Vegetation



COMMON	SCIENTIFIC	FORM	ZONE	INDICATOR	TOLERANCE			HARDINESS
					INUNDATION	POLLUTION	SALT	
BLACK-HAW	<i>Viburnum prunifolium</i>	Shrub	[3,4,5],6	FACU,FACU+	YES	<input type="checkbox"/>	<input type="checkbox"/>	3
BLACK-HAW,RUSTY	<i>Viburnum rufidulum</i>	Shrub	3,[4,5,6]	UPL,FACU	NO	<input type="checkbox"/>	<input type="checkbox"/>	5
BLADDERNUT, AMERICAN	<i>Staphylea trifolia</i>	Shrub-Tree	[3,4],5	FAC	YES	<input type="checkbox"/>	<input type="checkbox"/>	3
BLUEBERRY,BOG	<i>Vaccinium uliginosum</i>	Shrub	2,3,4,5,6	FACU+,FACW+	YES	<input type="checkbox"/>	<input type="checkbox"/>	
BLUEBERRY,CREEPING	<i>Vaccinium crassifolium</i>	Shrub	[2,3,4],5	FAC,FAC+	YES	<input type="checkbox"/>	<input type="checkbox"/>	
BLUEBERRY,HIGHBUSH	<i>Vaccinium atrococcum</i>	Shrub	[2,3]	FACW	SEASONAL	<input type="checkbox"/>	<input type="checkbox"/>	3
BLUEBERRY,LOWBUSH	<i>Vaccinium angustifolium</i>	Shrub	3,[4,5,6]	FACU-,FACU	NO	<input type="checkbox"/>	<input type="checkbox"/>	2
BLUEBERRY,VELVET-LEAF	<i>Vaccinium myrtilloides</i>	Shrub	1,2,[3,4,5],	FACU,FACW-	YES	<input type="checkbox"/>	<input type="checkbox"/>	2
BOX-ELDER	<i>Acer negundo</i>	Tree	2,[3,4]	FAC+	SEASONAL	<input type="checkbox"/>	<input type="checkbox"/>	2
BUCKTHORN,CAROLINA	<i>Rhamnus caroliniana</i>	Shrub	2,[3,4,5,6]	FACU-,FAC	YES	<input type="checkbox"/>	<input type="checkbox"/>	5-6
BUCKTHORN,LANCE-LEAF	<i>Rhamnus lanceolata</i>	Shrub	6	NI	NO	<input type="checkbox"/>	<input type="checkbox"/>	5
BUFFALO-BERRY,CANADA	<i>Shepherdia canadensis</i>	Shrub	6	NI	NO	<input type="checkbox"/>	<input checked="" type="checkbox"/>	
BURNING-BUSH,EASTERN	<i>Euonymus atropurpureus</i>	Shrub	[2,3,4,5],6	FACU,FAC+	YES	<input type="checkbox"/>	<input type="checkbox"/>	4
BUTTERNUT	<i>Juglans cinerea</i>	Tree	[3,4,5,6]	FACU-,FACU+	YES	<input type="checkbox"/>	<input type="checkbox"/>	3
BUTTONBUSH,COMMON	<i>Cephalanthus occidentalis</i>	Shrub	[1,2],3	OBL	0-3'	<input type="checkbox"/>	<input type="checkbox"/>	
CEDAR,ATLANTIC WHITE	<i>Chamaecyparis thyoides</i>	Tree	[1,2],3	OBL	SATURATE	<input type="checkbox"/>	<input type="checkbox"/>	3
CEDAR,EASTERN RED	<i>Juniperus virginiana</i>	Shrub	4,5,6	FACU	NO	<input checked="" type="checkbox"/>	<input type="checkbox"/>	2
CEDAR,NORTHERN WHITE	<i>Thuja occidentalis</i>	Tree	[2,3],4	FACW	SEASONAL	<input type="checkbox"/>	<input type="checkbox"/>	2
CHERRY,BLACK	<i>Prunus serotina</i>	Tree	[4,5],6	FACU	NO	<input type="checkbox"/>	<input type="checkbox"/>	3
CHERRY,CHOKE	<i>Prunus virginiana</i>	Tree	4,5,6	FACU	YES	<input type="checkbox"/>	<input type="checkbox"/>	5,6
CHERRY,FIRE	<i>Prunus pensylvanica</i>	Tree	4,5,6	FACU	NO	<input type="checkbox"/>	<input type="checkbox"/>	2
COTTON-WOOD,EASTERN	<i>Populus deltoides</i>	Tree	[3,4],5	FAC	SEASONAL	<input checked="" type="checkbox"/>	<input checked="" type="checkbox"/>	2
COTTON-WOOD,SWAMP	<i>Populus heterophylla</i>	Tree	[2,3]	FACW+	YES	<input type="checkbox"/>	<input type="checkbox"/>	
CRANBERRY,MOUNTAIN	<i>Vaccinium vitis-idaea</i>	Shrub	2,[3,4],5	FAC	YES	<input type="checkbox"/>	<input type="checkbox"/>	2
CRANBERRY,SMALL	<i>Vaccinium oxycoccos</i>	Shrub	[1,2],3	OBL	YES	<input type="checkbox"/>	<input type="checkbox"/>	2

### Stormwater Plant List - Woody Vegetation

COMMON	SCIENTIFIC	FORM	ZONE	INDICATOR	TOLERANCE			HARDINESS
					INUNDATION	POLLUTION	SALT	
CRANBERRY,SOUTHERN MOUNTAIN	<i>Vaccinium erythrocarpum</i>	Shrub	2,[3,4],5	FAC	YES	<input type="checkbox"/>	<input type="checkbox"/>	5
CYPRESS,BALD	<i>Taxodium distichum</i>	Tree	[1,2],3	OBL	SATURATED	<input type="checkbox"/>	<input type="checkbox"/>	4
DANGLE-BERRY	<i>Gaylussacia frondosa</i>	Shrub	2,[3,4],5	FAC	YES	<input type="checkbox"/>	<input type="checkbox"/>	
DEERBERRY	<i>Vaccinium stamineum</i>	Shrub	[3,4,5,6]	FACU-,FACU+	YES	<input type="checkbox"/>	<input type="checkbox"/>	5
DOG-HOBBLE,COASTAL	<i>Leucothoe axillaris</i>	Shrub	[1,2,3,4],5	FACW,FACW+	YES	<input type="checkbox"/>	<input type="checkbox"/>	6
DOG-HOBBLE,RED-TWIG	<i>Leucothoe recurva</i>	Shrub	3,[4,5],6	FACU	NO	<input type="checkbox"/>	<input type="checkbox"/>	5
DOGWOOD, GRAY	<i>Cornus racemosa</i>	Shrub	2[3,4]	FAC+	SEASONAL	<input type="checkbox"/>	<input type="checkbox"/>	
DOGWOOD,FLOWERING	<i>Cornus florida</i>	Shrub-Tree	4,5,6	FACU-	NO	<input type="checkbox"/>	<input type="checkbox"/>	4
DOGWOOD,ROUGH-LEAF	<i>Cornus asperifolia</i>	Shrub	1,2,[3,4,5]	FAC-,FACW-	YES	<input type="checkbox"/>	<input type="checkbox"/>	
DOGWOOD,ROUGH-LEAF	<i>Cornus drummondii</i>	Shrub	2,[3,4],5	FAC	YES	<input type="checkbox"/>	<input type="checkbox"/>	4
DOGWOOD,SILKY	<i>Cornus amomum</i>	Shrub	[2,3],4	FACW	SEASONAL	<input type="checkbox"/>	<input type="checkbox"/>	5
ELDER,EUROPEAN RED	<i>Sambucus racemosa</i>	Shrub	[3,4,5],6	FACU,FACU+	YES	<input type="checkbox"/>	<input type="checkbox"/>	4
ELM,SLIPPERY	<i>Ulmus rubra</i>	Tree	[3,4],5	FAC	YES	<input type="checkbox"/>	<input type="checkbox"/>	3
FALSE-WILLOW,EASTERN	<i>Baccharis halimifolia</i>	Shrub	1,[2,3,4],5	FAC,FACW	0-6"	<input type="checkbox"/>	<input type="checkbox"/>	
FARKLEBERRY	<i>Vaccinium arboreum</i>	Shrub	3,[4,5],6	FACU	NO	<input type="checkbox"/>	<input type="checkbox"/>	7
FETTER-BUSH	<i>Leucothoe racemosa</i>	Shrub	1,[2,3,4],5	FACW	SEASONAL	<input type="checkbox"/>	<input type="checkbox"/>	5
FETTER-BUSH	<i>Lyonia lucida</i>	Shrub	1,[2,3,4],5	FACW	YES	<input type="checkbox"/>	<input type="checkbox"/>	
GERMANDER,AMERICAN	<i>Teucrium canadense</i>	Shrub	1,[2,3,4],5	FAC+,FACW	YES	<input type="checkbox"/>	<input type="checkbox"/>	
GROUNDSEL TREE	<i>Baccharis halimifolia</i>	Shrub	[2,3]4	FACW		<input type="checkbox"/>	<input type="checkbox"/>	
GUM,SWEET	<i>Liquidambar styraciflua</i>	Tree	[3,4],5	FAC	YES	<input type="checkbox"/>	<input type="checkbox"/>	4
HACKBERRY,COMMON	<i>Celtis occidentalis</i>	Shrub-Tree	4,5,6	FACU	SEASONAL	<input checked="" type="checkbox"/>	<input type="checkbox"/>	5
HAWTHORN,BEAUTIFUL	<i>Crataegus pulcherrima</i>	Tree	2,[3,4],5	FAC	YES	<input type="checkbox"/>	<input type="checkbox"/>	4
HAWTHORN,COCKSPUR	<i>Crataegus crus-galli</i>	Tree	2,[3,4,5],6	FACU,FAC	YES	<input checked="" type="checkbox"/>	<input type="checkbox"/>	4
HAWTHORN,DOWNY	<i>Crataegus mollis</i>	Tree	1,2,[3,4,5],	FACU,FACW-	YES	<input type="checkbox"/>	<input type="checkbox"/>	4
HAWTHORN,GREEN	<i>Crataegus viridis</i>	Tree	1,[2,3,4],5	FAC,FACW	YES	<input type="checkbox"/>	<input type="checkbox"/>	4

Stormwater Plant List - Woody Vegetation

COMMON	SCIENTIFIC	FORM	ZONE	INDICATOR	TOLERANCE			HARDINESS
					INUNDATION	POLLUTION	SALT	
HAWTHORN,LITTLE-HIP	<i>Crataegus spathulata</i>	Tree	1,[2,3,4],5	FAC,FACW	YES	<input type="checkbox"/>	<input type="checkbox"/>	4
HAWTHORN,PARSLEY	<i>Crataegus marshallii</i>	Tree	[1,2,3,4],5	FACU+,FACW	YES	<input type="checkbox"/>	<input type="checkbox"/>	4
HAWTHORN,WASHINGTON	<i>Crataegus phaenopyrum</i>	Tree	2,[3,4,5]	FAC-,FAC	YES	<input type="checkbox"/>	<input type="checkbox"/>	4
HAZEL-NUT,AMERICAN	<i>Corylus americana</i>	Shrub	3,[4,5,6]	UPL,FACU	NO	<input type="checkbox"/>	<input type="checkbox"/>	4
HAZEL-NUT,BEAKED	<i>Corylus cornuta</i>	Shrub	3,[4,5,6]	UPL,FACU	NO	<input type="checkbox"/>	<input type="checkbox"/>	4
HEATHER	<i>Calluna vulgaris</i>	Shrub	2,[3,4],5	FAC	YES	<input type="checkbox"/>	<input type="checkbox"/>	4
HEMLOCK,EASTERN	<i>Tsuga canadensis</i>	Tree	4,5,6	FACU	NO	<input type="checkbox"/>	<input type="checkbox"/>	3
HICKORY,BIG SHELLBARK	<i>Carya laciniosa</i>	Tree	1,[2,3,4],5	FAC,FACW	YES	<input type="checkbox"/>	<input type="checkbox"/>	5
HICKORY,BITTER-NUT	<i>Carya cordiformis</i>	Tree	4,5,6	FACU+	NO	<input type="checkbox"/>	<input type="checkbox"/>	4
HICKORY,PECAN	<i>Carya illinoensis</i>	Tree	1,[2,3,4,5],	FACU,FACW	YES	<input type="checkbox"/>	<input type="checkbox"/>	5
HICKORY,RED	<i>Carya ovalis</i>	Tree	3,[4,5,6]	UPL,FACU	NO	<input type="checkbox"/>	<input type="checkbox"/>	4
HICKORY,SHAG-BARK	<i>Carya ovata</i>	Tree	[3,4,5,6]	FACU-,FACU+	YES	<input type="checkbox"/>	<input type="checkbox"/>	4
HICKORY,SWEET PIGNUT	<i>Carya glabra</i>	Tree	3,[4,5,6]	FACU-,FACU	NO	<input type="checkbox"/>	<input type="checkbox"/>	4
HOLLY, WINTERBERRY	<i>Ilex laevigata</i>	Shrub	[1,2],3	OBL	YES	<input type="checkbox"/>	<input type="checkbox"/>	4
HOLLY,AMERICAN	<i>Ilex opaca</i>	Shrub	4,5,6	FACU	LIMITED	<input checked="" type="checkbox"/>	<input type="checkbox"/>	5
HOLLY,BAY-GALL	<i>Ilex coriacea</i>	Shrub	1,[2,3,4],5	FACW	YES	<input type="checkbox"/>	<input type="checkbox"/>	
HOLLY,DECIDUOUS	<i>Ilex decidua</i>	Shrub	1,[2,3,4,5]	FACW-,FACW	SEASONAL	<input type="checkbox"/>	<input type="checkbox"/>	
HOLLY,GEORGIA	<i>Ilex longipes</i>	Shrub	1,[2,3,4],5	FAC,FACW	YES	<input type="checkbox"/>	<input type="checkbox"/>	
HOLLY,SARVIS	<i>Ilex amelanchier</i>	Shrub	[1,2],3	OBL	YES	<input type="checkbox"/>	<input type="checkbox"/>	
HOP-HORNBEAM,EASTERN	<i>Ostrya virginiana</i>	Shrub-Tree	[3,4,5,6]	FACU-,FACU+	YES	<input type="checkbox"/>	<input type="checkbox"/>	4
HORNBEAM,AMERICAN	<i>Carpinus caroliniana</i>	Tree	[3,4],5	FAC	SOME	<input type="checkbox"/>	<input type="checkbox"/>	2
HUCKLEBERRY,BLACK	<i>Gaylussacia baccata</i>	Shrub	3,[4,5],6	FACU	NO	<input type="checkbox"/>	<input type="checkbox"/>	2
HUCKLEBERRY,DWARF	<i>Gaylussacia dumosa</i>	Shrub	2,[3,4],5	FAC	YES	<input type="checkbox"/>	<input type="checkbox"/>	2
HYDRANGEA,PANICLE	<i>Hydrangea paniculata</i>	Shrub	2,[3,4],5	FAC	YES	<input type="checkbox"/>	<input type="checkbox"/>	4
HYDRANGEA,WILD	<i>Hydrangea arborescens</i>	Shrub	3,[4,5,6]	UPL,FACU	NO	<input type="checkbox"/>	<input type="checkbox"/>	4

Stormwater Plant List - Woody Vegetation

COMMON	SCIENTIFIC	FORM	ZONE	INDICATOR	TOLERANCE			HARDINESS
					INUNDATION	POLLUTION	SALT	
INK-BERRY	<i>Ilex glabra</i>	Shrub	[2,3],4	FACW-	SEASONAL	<input type="checkbox"/>	<input type="checkbox"/>	3
LAUREL,MOUNTAIN	<i>Kalmia latifolia</i>	Shrub	4,5,6	FACU	NO	<input type="checkbox"/>	<input type="checkbox"/>	4
LOCUST,BLACK	<i>Robinia pseudoacacia</i>	Tree	4,5,6	FACU	YES	<input type="checkbox"/>	<input checked="" type="checkbox"/>	5
MAGNOLIA,UMBRELLA	<i>Magnolia tripetala</i>	Tree	2,[3,4,5],6	FACU,FAC	YES	<input type="checkbox"/>	<input type="checkbox"/>	4
MALEBERRY	<i>Lyonia ligustrina</i>	Shrub	1,[2,3,4],5	FACW	YES	<input type="checkbox"/>	<input type="checkbox"/>	3
MAPLE,MOUNTAIN	<i>Acer spicatum</i>	Tree	4,5,6	FACU	NO	<input type="checkbox"/>	<input type="checkbox"/>	2
MAPLE,RED	<i>Acer rubrum</i>	Tree	[3,4],5	FAC	SEASONAL	<input type="checkbox"/>	<input type="checkbox"/>	3
MAPLE,SILVER	<i>Acer saccharinum</i>	Tree	[2,3],4	FACW	SEASONAL	<input type="checkbox"/>	<input type="checkbox"/>	3
MAPLE,STRIPED	<i>Acer pensylvanicum</i>	Shrub-Tree	3,[4,5,6]	FACU-,FACU	NO	<input type="checkbox"/>	<input type="checkbox"/>	3
MARSH ELDER	<i>Iva frutescens</i>	Shrub	1[2,3]	FACW+		<input type="checkbox"/>	<input checked="" type="checkbox"/>	
MEADOW-SWEET,BROAD-LEAF	<i>Spiraea latifolia</i>	Shrub	[2,3,4]	FAC+,FACW	YES	<input type="checkbox"/>	<input type="checkbox"/>	2
MEADOW-SWEET,NARROW-LEAF	<i>Spiraea alba</i>	Shrub	[1,2,3,4],5	FACW,FACW+	YES	<input type="checkbox"/>	<input type="checkbox"/>	4
MEADOW-SWEET,VIRGINIA	<i>Spiraea virginiana</i>	Shrub	1,[2,3,4,5],	FACU,FACW	YES	<input type="checkbox"/>	<input type="checkbox"/>	5
MEADOW-SWEET,WILLOW-LEAF	<i>Spiraea salicifolia</i>	Shrub	1,[2,3]	FACW+	YES	<input type="checkbox"/>	<input type="checkbox"/>	4
NANNYBERRY	<i>Viburnum lentago</i>	Shrub	[3,4],5	FAC	SEASONAL	<input type="checkbox"/>	<input type="checkbox"/>	2
NINEBARK,EASTERN	<i>Physocarpus opulifolius</i>	Shrub	[2,3],4	FACW-	YES	<input type="checkbox"/>	<input type="checkbox"/>	2
OAK, PIN	<i>Quercus palustris</i>	Tree	[2,3],4	FACW	SEASONAL	<input checked="" type="checkbox"/>	<input type="checkbox"/>	4
OAK, SCARLET	<i>Quercus coccinea</i>	Tree	6		NO	<input type="checkbox"/>	<input type="checkbox"/>	
OAK,BUR	<i>Quercus macrocarpa</i>	Tree	3,[4,5],6	FAC-	YES	<input checked="" type="checkbox"/>	<input type="checkbox"/>	2
OAK,CHERRY-BARK	<i>Quercus falcata var. pagodafolia</i>	Tree	1,[2,3,4],5	FAC+,FACW	YES	<input type="checkbox"/>	<input type="checkbox"/>	5-6
OAK,CHESTNUT	<i>Quercus prinus</i>	Tree	4,5,6	FACU	NO	<input type="checkbox"/>	<input type="checkbox"/>	5,6
OAK,CHINKAPIN	<i>Quercus muhlenbergii</i>	Tree	[3,4],5	FAC	YES	<input type="checkbox"/>	<input type="checkbox"/>	5
OAK,LAUREL	<i>Quercus laurifolia</i>	Tree	1,[2,3,4,5]	FACW-,FACW	YES	<input type="checkbox"/>	<input type="checkbox"/>	
OAK,LIVE	<i>Quercus virginiana</i>	Tree	4,5,6	FACU	YES	<input type="checkbox"/>	<input checked="" type="checkbox"/>	7
OAK,OVERCUP	<i>Quercus lyrata</i>	Tree	[1,2],3	OBL	YES	<input type="checkbox"/>	<input type="checkbox"/>	5

Stormwater Plant List - Woody Vegetation

COMMON	SCIENTIFIC	FORM	ZONE	INDICATOR	TOLERANCE			HARDINESS
					INUNDATION	POLLUTION	SALT	
OAK,POST	<i>Quercus stellata</i>	Tree	3,[4,5,6]	UPL,FACU	NO	<input type="checkbox"/>	<input type="checkbox"/>	5
OAK,RED	<i>Quercus rubra</i>	Tree	6		NO	<input checked="" type="checkbox"/>	<input type="checkbox"/>	
OAK,SHINGLE	<i>Quercus imbricaria</i>	Tree	[3,4],5	FAC	YES	<input checked="" type="checkbox"/>	<input type="checkbox"/>	5
OAK,SHUMARD	<i>Quercus shumardii</i>	Tree	2,[3,4]	FAC+	YES	<input type="checkbox"/>	<input type="checkbox"/>	5
OAK,SWAMP CHESTNUT	<i>Quercus michauxii</i>	Tree	1,[2,3,4,5]	FACW-,FACW	YES	<input type="checkbox"/>	<input type="checkbox"/>	
OAK,SWAMP WHITE	<i>Quercus bicolor</i>	Tree	1,[2,3]	FACW+	SEASONAL	<input type="checkbox"/>	<input type="checkbox"/>	3
OAK,WATER	<i>Quercus nigra</i>	Tree	[3,4],5	FAC	SEASONAL	<input type="checkbox"/>	<input type="checkbox"/>	6
OAK,WHITE	<i>Quercus alba</i>	Tree	[4,5,6]	FACU	YES	<input type="checkbox"/>	<input type="checkbox"/>	4
OAK,WILLOW	<i>Quercus phellos</i>	Tree	2,[3,4]	FAC+	SEASONAL	<input type="checkbox"/>	<input type="checkbox"/>	5
PEPPER-BUSH,SWEET	<i>Clethra alnifolia</i>	Shrub	2,[3,4]	FAC+	SEASONAL	<input type="checkbox"/>	<input checked="" type="checkbox"/>	3
PINE,EASTERN WHITE	<i>Pinus strobus</i>	Tree	4,5,6	FACU	NO	<input checked="" type="checkbox"/>	<input checked="" type="checkbox"/>	3
PINE,JERSEY	<i>Pinus virginiana</i>	Tree	6		NO	<input type="checkbox"/>	<input checked="" type="checkbox"/>	
PINE,LOBLOLLY	<i>Pinus taeda</i>	Tree	3,[4,5],6	FAC-	SEASONAL	<input type="checkbox"/>	<input type="checkbox"/>	
PINE,PITCH	<i>Pinus rigida</i>	Tree	4,5,6	FACU	SEASONAL	<input type="checkbox"/>	<input checked="" type="checkbox"/>	4
PINE,POND	<i>Pinus serotina</i>	Tree	[1,2],3	OBL	YES	<input type="checkbox"/>	<input type="checkbox"/>	
REDBUD,EASTERN	<i>Cercis canadensis</i>	Shrub-Tree	3,[4,5,6]	UPL,FACU	NO	<input type="checkbox"/>	<input type="checkbox"/>	4
RHODODENDRON	<i>Rhododendron canadense</i>	Shrub	1,[2,3,4],5	FACW	YES	<input type="checkbox"/>	<input type="checkbox"/>	2
RHODODENDRON,ROSEBAY	<i>Rhododendron maximum</i>	Shrub	[3,4],5	FAC	YES	<input type="checkbox"/>	<input type="checkbox"/>	3
ROSEMARY,BOG	<i>Andromeda polifolia</i>	Shrub	[1,2],3	OBL	YES	<input type="checkbox"/>	<input type="checkbox"/>	
SAND-MYRTLE	<i>Leiophyllum buxifolium</i>	Shrub	3,4,[5,6]	FACU-	NO	<input type="checkbox"/>	<input type="checkbox"/>	
SASSAFRAS	<i>Sassafras albidum</i>	Tree	3,[4,5,6]	FACU-,FACU	NO	<input type="checkbox"/>	<input type="checkbox"/>	4
SERVICE-BERRY,DOWNY	<i>Amelanchier arborea</i>	Shrub-Tree	2,[3,4,5],6	FAC-	YES	<input type="checkbox"/>	<input type="checkbox"/>	
SHEEP-LAUREL	<i>Kalmia angustifolia</i>	Shrub	3,[4,5],6	FAC	YES	<input type="checkbox"/>	<input type="checkbox"/>	2
SILVER-BERRY,AMERICAN	<i>Elaeagnus commutata</i>	Shrub	[6]	UPL	NO	<input type="checkbox"/>	<input type="checkbox"/>	
SNOWBELL,BIG-LEAF	<i>Styrax grandifolia</i>	Shrub	3,[4,5,6]	FACU-,FACU	NO	<input type="checkbox"/>	<input type="checkbox"/>	5

### Stormwater Plant List - Woody Vegetation

COMMON	SCIENTIFIC	FORM	ZONE	INDICATOR	TOLERANCE			HARDINESS
					INUNDATION	POLLUTION	SALT	
SPICEBUSH,NORTHERN	<i>Lindera benzoin</i>	Shrub	[2,3],4	FACW-	SEASONAL	<input type="checkbox"/>	<input type="checkbox"/>	3-5
STAGGER-BUSH,PIEDMONT	<i>Lyonia mariana</i>	Shrub	2,[3,4,5,6]	FACU-,FAC	YES	<input type="checkbox"/>	<input type="checkbox"/>	5
STEEPLE-BUSH	<i>Spiraea tomentosa</i>	Shrub	1,[2,3,4],5	FACW	YES	<input type="checkbox"/>	<input type="checkbox"/>	4
STRAWBERRY-BUSH,AMERICAN	<i>Euonymus americanus</i>	Shrub	1,[2,3,4,5],	FACU,FACW	YES	<input type="checkbox"/>	<input type="checkbox"/>	5
SUGAR-BERRY	<i>Celtis laevigata</i>	Shrub	1,[2,3,4,5,6]	UPL,FACW	YES	<input type="checkbox"/>	<input type="checkbox"/>	
SWEETSHRUB	<i>Calycanthus fertilis</i>	Shrub	[3,4,5],6	FACU,FACU+	YES	<input type="checkbox"/>	<input type="checkbox"/>	5
SYCAMORE,AMERICAN	<i>Platanus occidentalis</i>	Tree	[2,3],4	FACW-	SATURATED	<input type="checkbox"/>	<input type="checkbox"/>	
TEABERRY	<i>Gaultheria procumbens</i>	Shrub	3,[4,5],6	FACU	NO	<input type="checkbox"/>	<input type="checkbox"/>	3
TREE,TULIP	<i>Liriodendron tulipifera</i>	Tree	2,[3,4,5],6	FACU,FAC	YES	<input type="checkbox"/>	<input type="checkbox"/>	4
VIBURNUM,MAPLE-LEAF	<i>Viburnum acerifolium</i>	Shrub	3,[4,5,6]	UPL,FACU	NO	<input type="checkbox"/>	<input type="checkbox"/>	3
VIBURNUM,POSSUM-HAW	<i>Viburnum nudum</i>	Shrub	[1,2],3	OBL	YES	<input type="checkbox"/>	<input type="checkbox"/>	6
WILLOW,BLACK	<i>Salix nigra</i>	Tree	[2,3]	FACW+	SEASONAL	<input type="checkbox"/>	<input type="checkbox"/>	3
WILLOW,HEART-LEAF	<i>Salix cordata</i>	Shrub	1,[2,3,4],5	FAC,FACW	YES	<input type="checkbox"/>	<input type="checkbox"/>	3
WILLOW,SILKY	<i>Salix sericea</i>	Shrub	[1,2],3	OBL	YES	<input type="checkbox"/>	<input type="checkbox"/>	3
WILLOW,TALL PRAIRIE	<i>Salix humilis</i>	Shrub	3,[4,5],6	FACU	NO	<input type="checkbox"/>	<input type="checkbox"/>	3
WILLOW,VIRGINIA	<i>Itea virginica</i>	Shrub	[1,2],3	OBL	0-6"	<input type="checkbox"/>	<input type="checkbox"/>	5
WINTERBERRY,COMMON	<i>Ilex verticillata</i>	Shrub	1,[2,3]	FACW+	SEASONAL	<input type="checkbox"/>	<input type="checkbox"/>	3
WITCH-ALDER,DWARF	<i>Fothergilla gardenii</i>	Shrub	1,[2,3,4],5	FACW	YES	<input type="checkbox"/>	<input type="checkbox"/>	
WITCH-HAZEL, AMERICAN	<i>Hamamelis virginiana</i>	Shrub-Tree	3,[4,5],6	FAC-	NO	<input checked="" type="checkbox"/>	<input type="checkbox"/>	4
WITCH-HAZEL,AMERICAN	<i>Hamamelis virginiana</i>	Shrub-Tree	2,3,[4,5],6	FACU,FAC-	NO	<input checked="" type="checkbox"/>	<input type="checkbox"/>	4
WITHE-ROD	<i>Viburnum cassinoides</i>	Shrub	1,[2,3,4],5	FACW	YES	<input type="checkbox"/>	<input type="checkbox"/>	3
YAUPON	<i>Ilex vomitoria</i>	Shrub	3,[4,5],6	FAC-	YES	<input type="checkbox"/>	<input checked="" type="checkbox"/>	
YEW,AMERICAN	<i>Taxus canadensis</i>	Shrub	2,[3,4,5],6	FACU,FAC	YES	<input type="checkbox"/>	<input type="checkbox"/>	2

### Stormwater Plant List - Woody Vegetation

## Appendix A.4.2 Stormwater Plant List - Herbaceous Vegetation

COMMON	SCIENTIFIC	FORM	ZONE	INDICATOR	TOLERANCE			HARDINESS
					INUNDATION	POLLUTION	SALT	
ARROW-GRASS,MARSH	<i>Triglochin palustre</i>	Grass	[1,2],3	OBL	YES	<input type="checkbox"/>	<input type="checkbox"/>	
ARROW-HEAD,BROAD-LEAF	<i>Sagittaria latifolia</i>	Perennial	[1,2],3	OBL	0-2'	<input type="checkbox"/>	<input type="checkbox"/>	
ARROW-HEAD,COASTAL	<i>Sagittaria falcata</i>	Perennial	[1,2],3	OBL	YES	<input type="checkbox"/>	<input type="checkbox"/>	
ARROW-HEAD,GRASS-LEAF	<i>Sagittaria graminea</i>	Perennial	[1,2],3	OBL	0-1'	<input type="checkbox"/>	<input type="checkbox"/>	
ARROW-HEAD,NORTHERN	<i>Sagittaria cuneata</i>	Perennial	[1,2],3	OBL	YES	<input type="checkbox"/>	<input type="checkbox"/>	
ARROW-HEAD,SHORT-BEAK	<i>Sagittaria brevirostra</i>	Perennial	[1,2],3	OBL	YES	<input type="checkbox"/>	<input type="checkbox"/>	
ARROW-HEAD,WAPATO DUCK POTATO	<i>Sagittaria latifolia</i>	Perennial	[1,2],3	OBL	0-2'	<input type="checkbox"/>	<input type="checkbox"/>	3-8
ASTER,ANNUAL SALTMARSH	<i>Aster subulatus</i>	Annual	[1,2],4	OBL	YES	<input type="checkbox"/>	<input checked="" type="checkbox"/>	
ASTER,BOG	<i>Aster nemoralis</i>	Perennial	[2,3],4	FACW+	YES	<input type="checkbox"/>	<input type="checkbox"/>	
ASTER,BUSH	<i>Aster dumosus</i>	Perennial	[3,4],5	FAC	NO	<input type="checkbox"/>	<input type="checkbox"/>	
ASTER,CALICO	<i>Aster lateriflorus</i>	Perennial	[2,3,4]	FACW-	SEASONAL	<input type="checkbox"/>	<input type="checkbox"/>	
ASTER,CROOKED-STEM	<i>Aster prenanthoides</i>	Perennial	[3,4],5	FAC	NO	<input type="checkbox"/>	<input type="checkbox"/>	
ASTER,FLAT-TOP WHITE	<i>Aster umbellatus</i>	Perennial	[2,3],4	FACW	YES	<input type="checkbox"/>	<input type="checkbox"/>	
ASTER,NEW ENGLAND	<i>Aster novae-angliae</i>	Perennial	[2,3],4	FACW	YES	<input type="checkbox"/>	<input type="checkbox"/>	
ASTER,NEW YORK	<i>Aster novi-belgii</i>	Perennial	[2,3],4	FACW+	YES	<input type="checkbox"/>	<input type="checkbox"/>	
ASTER,ONTARIO	<i>Aster ontarionis</i>	Perennial	[3,4],5	FAC	NO	<input type="checkbox"/>	<input type="checkbox"/>	
ASTER,PANICLED	<i>Aster simplex</i>	Perennial	[2,3],4	FACW	YES	<input type="checkbox"/>	<input type="checkbox"/>	
ASTER,PERENNIAL SALTMARSH	<i>Aster tenuifolius</i>	Perennial	1,[2,3]	OBL	YES	<input type="checkbox"/>	<input checked="" type="checkbox"/>	
ASTER,SMALL WHITE	<i>Aster vimineus</i>	Perennial	[3,4,5]	FAC	NO	<input type="checkbox"/>	<input type="checkbox"/>	
ASTER,SWAMP	<i>Aster puniceus</i>	Perennial	1,[2,3]	OBL	YES	<input type="checkbox"/>	<input type="checkbox"/>	

Stormwater Plant List - Herbaceous Vegetation

COMMON	SCIENTIFIC	FORM	ZONE	INDICATOR	TOLERANCE			HARDINESS
					INUNDATION	POLLUTION	SALT	
ASTER,TRADESCANT	<i>Aster tradescanti</i>	Perennial	[2,3],4	FACW	YES	<input type="checkbox"/>	<input type="checkbox"/>	
ASTER,WHITE HEATH	<i>Aster ericoides</i>	Perennial	3,[4,5,6]	FACU	NO	<input type="checkbox"/>	<input type="checkbox"/>	
ASTER,WILLOW-LEAF	<i>Aster praealtus</i>	Perennial	[2,3],4	FACW	YES	<input type="checkbox"/>	<input type="checkbox"/>	
BABY-BLUE-EYES,SMALL-FLOWER	<i>Nemophila aphylla</i>	Annual	[2,3],4	FACW	YES	<input type="checkbox"/>	<input type="checkbox"/>	
BEACHGRASS,AMERICAN	<i>Ammophila breviligulata</i>	Grass	4,[5,6]	FACU-	NO	<input type="checkbox"/>	<input type="checkbox"/>	
BEAKRUSH,FASCICULATE	<i>Rhynchospora fascicularis</i>	Grass	[1,2],3	OBL	YES	<input type="checkbox"/>	<input type="checkbox"/>	
BEAKRUSH,GRAY'S	<i>Rhynchospora grayi</i>	Grass	2,3,4,5,6	FAC	NO	<input type="checkbox"/>	<input type="checkbox"/>	
BEAKRUSH,PINELAND	<i>Rhynchospora perplexa</i>	Grass	[2,3],4	FACW+	YES	<input type="checkbox"/>	<input type="checkbox"/>	
BEAKRUSH,TALL	<i>Rhynchospora macrostachya</i>	Grass	[1,2],3	OBL	YES	<input type="checkbox"/>	<input type="checkbox"/>	
BEARDTONGUE	<i>Penstemon digitalis</i>	Perennial	3,4,5	FAC	NO	<input type="checkbox"/>	<input type="checkbox"/>	3-8
BEARDTONGUE,LONG-SEPAL	<i>Penstemon calycosus</i>	Perennial	[4,5,6]	UPL,FACU	NO	<input type="checkbox"/>	<input type="checkbox"/>	
BEARDTONGUE,LOWLAND	<i>Penstemon alluviorum</i>	Perennial	[2,3,4]	FACW	YES	<input type="checkbox"/>	<input type="checkbox"/>	
BEEBALM	<i>Monarda didyma</i>	Perennial	3,4,5	FAC+	SATURATED	<input type="checkbox"/>	<input type="checkbox"/>	4-8
BENTGRASS,BROWN	<i>Agrostis canina</i>	Grass	[4,5,6]	FACU	NO	<input type="checkbox"/>	<input type="checkbox"/>	
BENTGRASS,PERENNIAL	<i>Agrostis perennans</i>	Grass	[4,5],6	FACU	YES	<input type="checkbox"/>	<input type="checkbox"/>	
BENTGRASS,SPREADING	<i>Agrostis stolonifera</i>	Grass	[2,3],4	FACW	YES	<input type="checkbox"/>	<input type="checkbox"/>	
BENTGRASS,WINTER	<i>Agrostis hyemalis</i>	Grass	[3,4],5	FAC	NO	<input type="checkbox"/>	<input type="checkbox"/>	
BERGAMOT,WILD	<i>Monarda fistulosa</i>	Perennial	[4,5,6]	UPL	NO	<input type="checkbox"/>	<input type="checkbox"/>	
BLACK-EYED SUSAN	<i>Rudbeckia hirta (yellow)</i>	Perennial	4,5,6	FACU-	NO	<input type="checkbox"/>	<input type="checkbox"/>	3-7
BLADDERWORT,COMMON	<i>Utricularia macrorhiza</i>	Perennial	[1,2],3	OBL	YES	<input type="checkbox"/>	<input type="checkbox"/>	
BLOODROOT	<i>Sanguinaria canadensis</i>	Perennial	4,[5,6]	UPL,FACU-	NO	<input type="checkbox"/>	<input type="checkbox"/>	
BLUEBELLS,VIRGINIA	<i>Mertensia virginica</i>	Perennial	[2,3],4	FACW	YES	<input type="checkbox"/>	<input type="checkbox"/>	

Stormwater Plant List - Herbaceous Vegetation



COMMON	SCIENTIFIC	FORM	ZONE	INDICATOR	TOLERANCE			HARDINESS
					INUNDATION	POLLUTION	SALT	
BLUE-EYE-GRASS	<i>Sisyrinchium capillare</i>	Grass	[2,3]4	FACW+	YES	<input type="checkbox"/>	<input type="checkbox"/>	
BLUEFLAG,SOUTHERN	<i>Iris shrevei</i>	Perennial	1,[2],3	OBL	YES	<input type="checkbox"/>	<input type="checkbox"/>	
BLUEFLAG,VIRGINIA	<i>Iris virginica</i>	Perennial	1,[2],3	OBL	YES	<input type="checkbox"/>	<input type="checkbox"/>	
BLUEGRASS,BOG	<i>Poa paludigena</i>	Grass	[2,3],4	FACW+	YES	<input type="checkbox"/>	<input type="checkbox"/>	
BLUEGRASS,GROVE	<i>Poa alsodes</i>	Grass	2,[3,4],5	FACW-	SEASONAL	<input type="checkbox"/>	<input type="checkbox"/>	
BLUEGRASS,LOW	<i>Poa alpigena</i>	Grass	2,[3,4],5	FACW-	SEASONAL	<input type="checkbox"/>	<input type="checkbox"/>	
BLUESTEM,BIG	<i>Andropogon gerardii</i>	Grass	[4,5],6	FAC	NO	<input type="checkbox"/>	<input type="checkbox"/>	
BLUESTEM,BUSHY	<i>Andropogon glomeratus</i>	Grass	[2,3],4	FACW+	YES	<input type="checkbox"/>	<input type="checkbox"/>	
BROOM-SEDGE	<i>Andropogon virginicus</i>	Grass	[4,5],6	FACU	NO	<input type="checkbox"/>	<input type="checkbox"/>	
BULRUSH, HARDSTEMMED	<i>Scirpus acutus</i>	Perennial	[1,2],3	OBL	0-3'	<input type="checkbox"/>	<input type="checkbox"/>	8
BULRUSH, SOFTSTEM	<i>Scirpus validus</i>	Perennial	[1,2],3	OBL	0-1'	<input type="checkbox"/>	<input type="checkbox"/>	8
BULRUSH,ALKALI	<i>Scirpus robustus</i>	Grass	1,[2],3	OBL	SALT, EDGE	<input type="checkbox"/>	<input checked="" type="checkbox"/>	
BULRUSH,CLINTON'S	<i>Scirpus clintonii</i>	Grass	[4,5,6]	FACU	NO	<input type="checkbox"/>	<input type="checkbox"/>	
BULRUSH,OLNEY'S	<i>Scirpus americanus</i>	Grass	[1,2],3	OBL	0-6"	<input type="checkbox"/>	<input type="checkbox"/>	
BULRUSH,RIVER	<i>Scirpus fluviatilis</i>	Grass	[1,2],3	OBL	0-1'	<input type="checkbox"/>	<input type="checkbox"/>	
BULRUSH,SPREADING	<i>Scirpus divaricatus</i>	Grass	[1,2],3	OBL	YES	<input type="checkbox"/>	<input type="checkbox"/>	
BULRUSH,THREE-SQUARE	<i>Scirpus pungens</i>	Grass	[2,3],4	FACW+	0-6"	<input type="checkbox"/>	<input type="checkbox"/>	
BURREED,AMERICAN	<i>Sparganium americanum</i>	Grass	[1,2],3	OBL	0-1'	<input type="checkbox"/>	<input type="checkbox"/>	
BURREED,GIANT	<i>Sparganium eurycarpum</i>	Grass	[1,2],3	OBL	YES	<input type="checkbox"/>	<input type="checkbox"/>	
BUSHCLOVER,NARROW-LEAF	<i>Lespedeza angustifolia</i>	Groundcover	4,5,6	FACU	NO	<input type="checkbox"/>	<input type="checkbox"/>	
BUTTER-CUP,ALLEGHENY MOUNTAIN	<i>Ranunculus allegheniensis</i>	Perennial	[3,4],5	FAC	NO	<input type="checkbox"/>	<input type="checkbox"/>	
BUTTER-CUP,POND	<i>Ranunculus subrigidus</i>	Perennial	[1,2],3	OBL	YES	<input type="checkbox"/>	<input type="checkbox"/>	

Stormwater Plant List - Herbaceous Vegetation

COMMON	SCIENTIFIC	FORM	ZONE	INDICATOR	TOLERANCE			HARDINESS
					INUNDATION	POLLUTION	SALT	
BUTTER-CUP,SEASIDE	<i>Ranunculus cymbalaria</i>	Perennial	[1,2],3	OBL	YES	<input type="checkbox"/>	<input type="checkbox"/>	
CAMPION, SNOWY	<i>Silene nivea</i>	Perennial	[3,4],5	FAC	NO	<input type="checkbox"/>	<input type="checkbox"/>	4-8
CARDINAL FLOWER	<i>Lobelia cardinalis</i>	Perennial	1,[2,3],4	FACW+	YES	<input type="checkbox"/>	<input type="checkbox"/>	2-8
CHICORY	<i>Cichorium intybus</i>	Perennial	5,6	UPL	NO	<input type="checkbox"/>	<input type="checkbox"/>	3-8
CLUB,GOLDEN	<i>Orontium aquaticum</i>	Perennial	[1,2],3	OBL	YES	<input type="checkbox"/>	<input type="checkbox"/>	
COLTSFOOT,SWEET	<i>Petasites palmatus</i>	Perennial	1,[2,3],4	FACW+	YES	<input type="checkbox"/>	<input type="checkbox"/>	
COLUMBINE,WILD	<i>Aquilegia canadensis</i>	Perennial	[3,4],5	FAC	NO	<input type="checkbox"/>	<input type="checkbox"/>	
CONEFLOWER,CUT-LEAF	<i>Rudbeckia laciniata</i>	Perennial	[2,3],4	FACW	YES	<input type="checkbox"/>	<input type="checkbox"/>	
CONEFLOWER,ORANGE	<i>Rudbeckia fulgida</i>	Perennial	[3,4],5	FAC	NO	<input type="checkbox"/>	<input type="checkbox"/>	
CONEFLOWER,SWEET	<i>Rudbeckia subtomentosa</i>	Perennial	[3,4],5	FAC	NO	<input type="checkbox"/>	<input type="checkbox"/>	
CORDGRASS,BIG	<i>Spartina cynosuroides</i>	Grass	[1,2],3	OBL	SALT, EDGE	<input type="checkbox"/>	<input checked="" type="checkbox"/>	
CORDGRASS,PRAIRIE	<i>Spartina pectinata</i>	Grass	[1,2],3	OBL	SALT, EDGE	<input type="checkbox"/>	<input checked="" type="checkbox"/>	
CORDGRASS,SALTMARSH	<i>Spartina alterniflora</i>	Grass	[1,2],3	OBL	SALT, EDGE	<input type="checkbox"/>	<input checked="" type="checkbox"/>	
CORDGRASS,SALTMEADOW	<i>Spartina patens</i>	Grass	1,[2,3],4	FACW+	SALT, EDGE	<input type="checkbox"/>	<input checked="" type="checkbox"/>	
CORNFLOWER	<i>Centaurea cyanus</i>	Perennial	5,6	UPL	NO	<input type="checkbox"/>	<input type="checkbox"/>	
CUTGRASS,RICE	<i>Leersia oryzoides</i>	Grass	[1,2],3	OBL	0-6"	<input type="checkbox"/>	<input type="checkbox"/>	
DAISY, OXEYE	<i>Chrysanthemum leucanthemum</i>	Perennial	5,6	UPL	NO	<input type="checkbox"/>	<input type="checkbox"/>	
DRAGON-HEAD,FALSE	<i>Physostegia virginiana</i>	Perennial	2,[3,4],5	FAC+	SATURATED	<input type="checkbox"/>	<input type="checkbox"/>	
DRAGON-HEAD,PURPLE	<i>Physostegia purpurea</i>	Perennial	[2,3],4	FACW	YES	<input type="checkbox"/>	<input type="checkbox"/>	
DRAGON-HEAD,SLENDER	<i>Physostegia intermedia</i>	Perennial	[2,[3,4]	FACW-	SEASONAL	<input type="checkbox"/>	<input type="checkbox"/>	
DRAGON-HEAD,SLENDER-LEAF	<i>Physostegia leptophylla</i>	Perennial	[1,2],3	OBL	YES	<input type="checkbox"/>	<input type="checkbox"/>	
DROPSEED,SEASHORE	<i>Sporobolus virginicus</i>	Grass	1,[2,3],4	FACW+	YES	<input type="checkbox"/>	<input type="checkbox"/>	

### Stormwater Plant List - Herbaceous Vegetation

COMMON	SCIENTIFIC	FORM	ZONE	INDICATOR	TOLERANCE			HARDINESS
					INUNDATION	POLLUTION	SALT	
DUCKWEED	<i>Lemna trinervis</i>	Perennial	[1,2],3	OBL	Fre Float	<input type="checkbox"/>	<input type="checkbox"/>	
DUCKWEED,LEAST	<i>Lemna minima</i>	Perennial	[1,2],3	OBL	Free Float	<input type="checkbox"/>	<input type="checkbox"/>	
DUCKWEED,LESSER	<i>Lemna minor</i>	Perennial	[1,2],3	OBL	Free Float	<input type="checkbox"/>	<input type="checkbox"/>	
DUCKWEED,MINUTE	<i>Lemna perpusilla</i>	Perennial	[1,2],3	OBL	Free Float	<input type="checkbox"/>	<input type="checkbox"/>	
DUCKWEED,PALE	<i>Lemna valdiviana</i>	Perennial	[1,2],3	OBL	Free Float	<input type="checkbox"/>	<input type="checkbox"/>	
DWARF PLAINS COREOPSIS	<i>Coreopsis tinctoria (dwarf)</i>	Annual	3,[4,5],6	FAC-	NO	<input type="checkbox"/>	<input type="checkbox"/>	
EELGRASS	<i>Zostera marina</i>	Perennial	[1,2],3	OBL	2-6'	<input type="checkbox"/>	<input checked="" type="checkbox"/>	3-8
FALSE-HELLEBORE,AMERICAN	<i>Veratrum viride</i>	Perennial	[2,3,4]	FACW+	YES	<input type="checkbox"/>	<input type="checkbox"/>	
FALSE-SOLOMON'S-SEAL,FEATHER	<i>Smilacina racemosa</i>	Perennial	[4,5],6	FACU-	NO	<input type="checkbox"/>	<input type="checkbox"/>	
FERN,CINNAMON	<i>Osmunda cinnamomea</i>	Fern	[2,3],4	FACW	SATURATE	<input type="checkbox"/>	<input type="checkbox"/>	
FERN,NEW YORK	<i>Thelypteris noveboracensis</i>	Fern	[3,4],5	FAC	SATURATE	<input type="checkbox"/>	<input type="checkbox"/>	
FERN,ROYAL	<i>Osmunda regalis</i>	Fern	[1,2],3	OBL	SATURATE	<input type="checkbox"/>	<input type="checkbox"/>	
FERN,SENSITIVE	<i>Onoclea sensibilis</i>	Fern	[2,3],4	FACW	SATURATE	<input type="checkbox"/>	<input type="checkbox"/>	
FESCUE,MEADOW	<i>Festuca pratensis</i>	Grass	[3,4,5,6]	FACU-	NO	<input type="checkbox"/>	<input type="checkbox"/>	
FESCUE,NODDING	<i>Festuca obtusa</i>	Grass	[4,5],6	FACU	NO	<input type="checkbox"/>	<input type="checkbox"/>	
FESCUE,RED	<i>Festuca rubra</i>	Groundcover	[4,5]	FACU	NO	<input type="checkbox"/>	<input type="checkbox"/>	
FLATSEEDGE,MARSH	<i>Cyperus pseudovegetus</i>	Grass	[2,3],4	FACW	YES	<input type="checkbox"/>	<input type="checkbox"/>	
FLATSEEDGE,POORLAND	<i>Cyperus compressus</i>	Grass	[3,4],5	FAC+	SATURATE	<input type="checkbox"/>	<input type="checkbox"/>	
FLATSEEDGE,RUSTY	<i>Cyperus odoratus</i>	Grass	[2,3],4	FACW	YES	<input type="checkbox"/>	<input type="checkbox"/>	
FLATSEEDGE,SHORT-LEAF	<i>Cyperus brevifolius</i>	Grass	[1,2],3	OBL	YES	<input type="checkbox"/>	<input type="checkbox"/>	
FLATSEEDGE,SLENDER	<i>Cyperus filicinus</i>	Grass	2,[3,4,5,6]	UPL,FAC	YES	<input type="checkbox"/>	<input type="checkbox"/>	
FLAX, VIRGINIA	<i>Linum virginianum</i>	Perennial	5,6	FACU	NO	<input type="checkbox"/>	<input type="checkbox"/>	1-8

Stormwater Plant List - Herbaceous Vegetation

COMMON	SCIENTIFIC	FORM	ZONE	INDICATOR	TOLERANCE			HARDINESS
					INUNDATION	POLLUTION	SALT	
FLOATING-HEART, YELLOW	<i>Nymphoides peltata</i>	Perennial	[1,2],3	OBL	YES	<input type="checkbox"/>	<input type="checkbox"/>	
FORGET-ME-NOT, FIELD	<i>Myosotis arvensis</i>	Perennial	[3,4,5,6]	UPL	NO	<input type="checkbox"/>	<input type="checkbox"/>	
FOUR-O'CLOCK, HEART-LEAF	<i>Mirabilis nyctaginea</i>	Perennial	[4,5,6]	FACU	NO	<input type="checkbox"/>	<input type="checkbox"/>	
FOXTAIL, MEADOW	<i>Alopecurus geniculatus</i>	Grass	[1,2],3	OBL	YES	<input type="checkbox"/>	<input type="checkbox"/>	
FOXTAIL, MEADOW	<i>Alopecurus pratensis</i>	Grass	[2,3],4	FACW	YES	<input type="checkbox"/>	<input type="checkbox"/>	
FOXTAIL, MOUSE	<i>Alopecurus myosuroides</i>	Grass	[2,3],4	FACW	YES	<input type="checkbox"/>	<input type="checkbox"/>	
FOXTAIL, SHORT-AWN	<i>Alopecurus aequalis</i>	Grass	[1,2],3	OBL	YES	<input type="checkbox"/>	<input type="checkbox"/>	
FOXTAIL, TUFTED	<i>Alopecurus carolinianus</i>	Grass	[2,3],4	FACW	YES	<input type="checkbox"/>	<input type="checkbox"/>	
GLASSWORT, VIRGINIA	<i>Salicornia virginica</i>	Perennial	[1,2],3	OBL	SALT, EDGE	<input type="checkbox"/>	<input type="checkbox"/>	
GOLDEN-ROD	<i>Solidago austrina</i>	Perennial	[1,2],3	OBL	YES	<input type="checkbox"/>	<input type="checkbox"/>	
GOLDEN-ROD, COAST	<i>Solidago spathulata</i>	Perennial	4,[5,6]	FACU-	NO	<input type="checkbox"/>	<input type="checkbox"/>	
GOLDEN-ROD, SEASIDE	<i>Solidago sempervirens</i>	Perennial	[2,3],4	FACW	YES	<input type="checkbox"/>	<input type="checkbox"/>	
GOLDEN-ROD, STIFF	<i>Solidago rigida</i>	Perennial	1,2,3	OBL	NO	<input type="checkbox"/>	<input type="checkbox"/>	
GRASS, BROOM PANIC	<i>Dichanthelium scoparium</i>	Grass	[2,3],4	FACW	YES	<input type="checkbox"/>	<input type="checkbox"/>	
GRASS, CANADA MANNA	<i>Glyceria canadensis</i>	Grass	[1,2],3	OBL	0-1'	<input type="checkbox"/>	<input type="checkbox"/>	
GRASS, EASTERN MANNA	<i>Glyceria septentrionalis</i>	Grass	[1,2],3	OBL	0-1'	<input type="checkbox"/>	<input type="checkbox"/>	
GRASS, FOWL MANNA	<i>Glyceria striata</i>	Grass	[1,2],3	OBL	SEASONAL	<input type="checkbox"/>	<input type="checkbox"/>	
GRASS, PANIC	<i>Dichanthelium acuminatum</i>	Grass	[2,3],4	FAC	NO	<input type="checkbox"/>	<input type="checkbox"/>	
GRASS, PANIC	<i>Panicum longifolium</i>	Grass	[1,2],3	OBL	YES	<input type="checkbox"/>	<input type="checkbox"/>	
GRASS, ROUGH BARNYARD	<i>Echinochloa muricata</i>	Grass	[2,3],4	FACW+	YES	<input type="checkbox"/>	<input type="checkbox"/>	
GRASS, SALTMARSH ALKALI	<i>Puccinellia fasciculata</i>	Grass	[1,2],3	OBL	YES	<input type="checkbox"/>	<input type="checkbox"/>	
GRASS, SALTMEADOW	<i>Spartina caespitosa</i>	Grass	[1,2],3	OBL	YES	<input type="checkbox"/>	<input type="checkbox"/>	

Stormwater Plant List - Herbaceous Vegetation

COMMON	SCIENTIFIC	FORM	ZONE	INDICATOR	TOLERANCE			HARDINESS
					INUNDATION	POLLUTION	SALT	
HORNWORT,COMMON	<i>Ceratophyllum demersum</i>	Perennial	[1,2],3	OBL	1-5'	<input type="checkbox"/>	<input type="checkbox"/>	
HORSETAIL,ROUGH	<i>Equisetum hyemale</i>	Grass	[2,3],4	FACW	YES	<input type="checkbox"/>	<input type="checkbox"/>	
INDIAN-TOBACCO	<i>Lobelia inflata</i>	Perennial	[4,5,6]	FACU	NO	<input type="checkbox"/>	<input type="checkbox"/>	
IRIS, BLUE WATER	<i>Iris versicolor</i>	Perennial	[1,2],3	OBL	0-6"	<input type="checkbox"/>	<input type="checkbox"/>	2-7
IRIS,BEACH-HEAD	<i>Iris hookeri</i>	Perennial	4,[5,6]	FACU-	NO	<input type="checkbox"/>	<input type="checkbox"/>	
IRIS,BEACH-HEAD	<i>Iris setosa</i>	Perennial	[3,4],5	FAC	NO	<input type="checkbox"/>	<input type="checkbox"/>	
IRIS,COPPER	<i>Iris fulva</i>	Perennial	[1,2],3	OBL	YES	<input type="checkbox"/>	<input type="checkbox"/>	
IRIS,LAMANCE	<i>Iris brevicaulis</i>	Perennial	[1,2],3	OBL	YES	<input type="checkbox"/>	<input type="checkbox"/>	
JACK-IN-THE-PULPIT,SWAMP	<i>Arisaema triphyllum</i>	Perennial	[2,3],4	FACW	SEASONAL	<input type="checkbox"/>	<input type="checkbox"/>	
JACOB'S LADDER	<i>Polemonium reptans</i>	Perennial	[4,5],6	FACU	NO	<input type="checkbox"/>	<input type="checkbox"/>	3-8
JACOB'S-LADDER,BOG	<i>Polemonium van-bruntiae</i>	Perennial	[3,4],5	FAC+	SATURATED	<input type="checkbox"/>	<input type="checkbox"/>	
LILY,CANADA	<i>Lilium canadense</i>	Perennial	2,[3,4]	FAC+	YES	<input type="checkbox"/>	<input type="checkbox"/>	
LILY,CAROLINA	<i>Lilium michauxii</i>	Perennial	[3,4,5]	FAC	NO	<input type="checkbox"/>	<input type="checkbox"/>	
LILY,GRAY'S	<i>Lilium grayi</i>	Perennial	3,[4,5],6	FACU	NO	<input type="checkbox"/>	<input type="checkbox"/>	
LILY,SOUTHERN RED	<i>Lilium catesbaei</i>	Perennial	[2,3,4]	FACW	YES	<input type="checkbox"/>	<input type="checkbox"/>	
LILY,TURK'S-CAP	<i>Lilium superbum</i>	Perennial	[2,3,4]	FACW+	YES	<input type="checkbox"/>	<input type="checkbox"/>	
LIZARDS TAIL	<i>Saururus cemuus</i>	Perennial	2,3,4	OBL	0-1'	<input type="checkbox"/>	<input type="checkbox"/>	2-8
LOBELIA,BOYKIN'S	<i>Lobelia boykinii</i>	Perennial	[1,2],3	OBL	YES	<input type="checkbox"/>	<input type="checkbox"/>	
LOBELIA,BROOK	<i>Lobelia kalmii</i>	Perennial	[1,2],3	OBL	YES	<input type="checkbox"/>	<input type="checkbox"/>	
LOBELIA,DOWNY	<i>Lobelia puberula</i>	Perennial	[2,3,4]	FACW-	SEASONAL	<input type="checkbox"/>	<input type="checkbox"/>	
LOBELIA,ELONGATED	<i>Lobelia elongata</i>	Perennial	[1,2],3	OBL	YES	<input type="checkbox"/>	<input type="checkbox"/>	
LOBELIA,GEORGIA	<i>Lobelia georgiana</i>	Perennial	[2,3,4]	FACW	YES	<input type="checkbox"/>	<input type="checkbox"/>	

Stormwater Plant List - Herbaceous Vegetation

COMMON	SCIENTIFIC	FORM	ZONE	INDICATOR	TOLERANCE			HARDINESS
					INUNDATION	POLLUTION	SALT	
LOBELIA,GREAT BLUE	<i>Lobelia siphilitica</i>	Perennial	[2,3],4	FACW+	YES	<input type="checkbox"/>	<input type="checkbox"/>	
LOBELIA,NUTTALL'S	<i>Lobelia nuttallii</i>	Perennial	[2,3,4]	FACW	YES	<input type="checkbox"/>	<input type="checkbox"/>	
LOBELIA,PALE-SPIKE	<i>Lobelia spicata</i>	Perennial	[3,4,5]	FAC-	NO	<input type="checkbox"/>	<input type="checkbox"/>	
LOBELIA,SOUTHERN	<i>Lobelia amoena</i>	Perennial	[1,2],3	OBL	YES	<input type="checkbox"/>	<input type="checkbox"/>	
LOBELIA,WATER	<i>Lobelia dortmanna</i>	Perennial	[1,2],3	OBL	YES	<input type="checkbox"/>	<input type="checkbox"/>	
LOTUS,AMERICAN	<i>Nelumbo lutea</i>	Perennial	[1,2],3	OBL	1-5'	<input type="checkbox"/>	<input type="checkbox"/>	
LOTUS,SACRED	<i>Nelumbo nucifera</i>	Perennial	[1,2],3	OBL	1-5'	<input type="checkbox"/>	<input type="checkbox"/>	
LOVEGRASS,MEADOW	<i>Eragrostis refracta</i>	Grass	[2,3],4	FACW	YES	<input type="checkbox"/>	<input type="checkbox"/>	
LOVEGRASS,PURPLE	<i>Eragrostis pectinacea</i>	Grass	[4,5],6	FAC	NO	<input type="checkbox"/>	<input type="checkbox"/>	
MALLOW,VIRGINIA SEASHORE	<i>Kosteletzkya virginica</i>	Perennial	[1,2],3	OBL	SALT, EDGE	<input type="checkbox"/>	<input checked="" type="checkbox"/>	
MARSH MARIGOLD	<i>Caltha palustris</i>	Perennial	3,4	OBL	6"SATURATE	<input type="checkbox"/>	<input type="checkbox"/>	3-8
MARSH SMARTWEED	<i>Polygonum hydropiperoides</i>	Perennial	2,3	OBL	0-1'	<input type="checkbox"/>	<input type="checkbox"/>	2-8
MARSH SMARTWEED	<i>Polygonum punctatum</i>	Perennial	2,3	OBL	SATURATE	<input type="checkbox"/>	<input type="checkbox"/>	2-8
MARSH-MALLOW,COMMON	<i>Althaea officinalis</i>	Perennial	[1,2,3]	FACW+	YES	<input type="checkbox"/>	<input type="checkbox"/>	
MEADOW-RUE,PIEDMONT	<i>Thalictrum macrostylum</i>	Perennial	[2,3,4]	FACW	YES	<input type="checkbox"/>	<input type="checkbox"/>	
MILKWORT,MARYLAND	<i>Polygala mariana</i>	Annual	[2,3,4]	FACW	YES	<input type="checkbox"/>	<input type="checkbox"/>	
MONKEY-FLOWER	<i>Mimulus ringens</i>	Perennial	[1,2],3	OBL	YES	<input type="checkbox"/>	<input type="checkbox"/>	3-8
MONKEY-FLOWER,COMMON LARGE	<i>Mimulus guttatus</i>	Annual	[1,2],3	OBL	YES	<input type="checkbox"/>	<input type="checkbox"/>	
MOUNTAIN-MINT,NARROW-LEAF	<i>Pycnanthemum flexuosum</i>	Perennial	[2,3,4]	FACW	YES	<input type="checkbox"/>	<input type="checkbox"/>	
MUHLY,MARSH	<i>Muhlenbergia glomerata</i>	Grass	[2,3],4	FACW	YES	<input type="checkbox"/>	<input type="checkbox"/>	
NIMBLE-WILL	<i>Muhlenbergia schreberi</i>	Grass	[3,4,5]	FAC	NO	<input type="checkbox"/>	<input type="checkbox"/>	
NUTRUSH	<i>Scleria flaccida</i>	Grass	[2,3],4	FACW	YES	<input type="checkbox"/>	<input type="checkbox"/>	

Stormwater Plant List - Herbaceous Vegetation

COMMON	SCIENTIFIC	FORM	ZONE	INDICATOR	TOLERANCE			HARDINESS
					INUNDATION	POLLUTION	SALT	
PANSY, FIELD	<i>Viola bicolor</i>	Annual	[4,5,6]	FACU	NO	<input type="checkbox"/>	<input type="checkbox"/>	
PARTRIDGE-BERRY	<i>Mitchella repens</i>	Groundcover	[4,5],6	FACU	NO	<input type="checkbox"/>	<input type="checkbox"/>	
PENNSYLVANIA SMARTWEED	<i>Polygonum pensylvanicum</i>	Annual	[2,3]	FACW	0-6"	<input type="checkbox"/>	<input type="checkbox"/>	2-8
PENNY-WORT, MANY-FLOWER	<i>Hydrocotyle umbellata</i>	Perennial	[1,2],3	OBL	0-1'	<input type="checkbox"/>	<input type="checkbox"/>	
PHLOX, FALL	<i>Phlox paniculata</i>	Perennial	[4,5],6	FACU	NO	<input type="checkbox"/>	<input type="checkbox"/>	
PHLOX, MEADOW	<i>Phlox maculata</i>	Perennial	[2,3,4]	FACW	YES	<input type="checkbox"/>	<input type="checkbox"/>	
PHLOX, WOODLAND	<i>Phlox divaricata</i>	Perennial	[4,5,6]	FACU	NO	<input type="checkbox"/>	<input type="checkbox"/>	
PICKERELWEED	<i>Pontederia cordata</i>	Perennial	2,3	OBL	0-1'	<input type="checkbox"/>	<input type="checkbox"/>	2-8
PLANTAIN, SEASIDE	<i>Plantago maritima</i>	Perennial	1,2,3,4	FACW	YES	<input type="checkbox"/>	<input type="checkbox"/>	
PLUMEGRASS, SUGARCANE	<i>Erianthus giganteus</i>	Grass	[2,3]	FACW+	YES	<input type="checkbox"/>	<input type="checkbox"/>	
PONDWEED, CLASPING-LEAF	<i>Potamogeton perfoliatus</i>	Perennial	[1,2],3	OBL	1' MIN-6'	<input type="checkbox"/>	<input type="checkbox"/>	
PONDWEED, LONG-LEAF	<i>Potamogeton nodosus</i>	Perennial	[1,2]	OBL	1' MIN-6'	<input type="checkbox"/>	<input type="checkbox"/>	
PONDWEED, SAGO	<i>Potamogeton pectinatus</i>	Perennial	[1,2]	OBL	1' MIN-24'	<input type="checkbox"/>	<input type="checkbox"/>	
PRIMROSE, BIRDSEYE	<i>Primula laurentiana</i>	Perennial	[4],5	FAC	NO	<input type="checkbox"/>	<input type="checkbox"/>	
REED, MEADOWGRASS	<i>Glyceria maxima</i>	Grass	[1,2],3	OBL	YES	<input type="checkbox"/>	<input type="checkbox"/>	
REEDGRASS, BLUE-JOINT	<i>Calamagrostis canadensis</i>	Grass	[1,2],3	FACW+	6" SATURATE	<input type="checkbox"/>	<input type="checkbox"/>	
ROCKCRESS, ALPINE	<i>Arabis alpina</i>	Perennial	[3,4,5]	FAC+	SATURATE	<input type="checkbox"/>	<input type="checkbox"/>	
ROSE-GENTIAN, NARROW-LEAF	<i>Sabatia brachiata</i>	Annual	[4,5,6]	FACU	NO	<input type="checkbox"/>	<input type="checkbox"/>	
RUSH, ARCTIC	<i>Juncus arcticus</i>	Grass	[1,2],3	OBL	YES	<input type="checkbox"/>	<input type="checkbox"/>	
RUSH, GRASS-LEAF	<i>Juncus marginatus</i>	Grass	[2,3],4	FACW	YES	<input type="checkbox"/>	<input type="checkbox"/>	
RUSH, NARROW-PANICLE	<i>Juncus brevicaudatus</i>	Grass	[1,2],3	OBL	YES	<input type="checkbox"/>	<input type="checkbox"/>	
RUSH, NEEDLEGRASS	<i>Juncus roemeranus</i>	Grass	[1,2],3	OBL	SALT, EDGE	<input type="checkbox"/>	<input checked="" type="checkbox"/>	

Stormwater Plant List - Herbaceous Vegetation

COMMON	SCIENTIFIC	FORM	ZONE	INDICATOR	TOLERANCE			HARDINESS
					INUNDATION	POLLUTION	SALT	
RUSH,SALTMEADOW	<i>Juncus gerardii</i>	Grass	[2,3],4	FACW+	YES	<input type="checkbox"/>	<input type="checkbox"/>	
RUSH,SLIM-POD	<i>Juncus diffusissimus</i>	Grass	[2,3],4	FACW	YES	<input type="checkbox"/>	<input type="checkbox"/>	
RUSH,SOFT	<i>Juncus effusus</i>	Grass	[2,3],4	FACW+	0-1'	<input type="checkbox"/>	<input type="checkbox"/>	4-8
RUSH,TURNFLOWER	<i>Juncus biflorus</i>	Grass	[2,3],4	FACW	YES	<input type="checkbox"/>	<input type="checkbox"/>	
RYEGRASS,PERENNIAL	<i>Lolium perenne</i>	Groundcover	[4,5,6]	FACU-	NO	<input type="checkbox"/>	<input type="checkbox"/>	
SALTGRASS,SEASHORE	<i>Distichlis spicata</i>	Grass	[2,3],4	FACW+	SALT, EDGE	<input type="checkbox"/>	<input checked="" type="checkbox"/>	
SAWGRASS,SMOOTH	<i>Cladium mariscoides</i>	Grass	[1,2],3	OBL	YES	<input type="checkbox"/>	<input type="checkbox"/>	
SAXIFRAGE,SWAMP	<i>Saxifraga pensylvanica</i>	Perennial	[1,2],3	OBL	YES	<input type="checkbox"/>	<input type="checkbox"/>	
SAXIFRAGE,VIRGINIA	<i>Saxifraga virginensis</i>	Perennial	[4,5]	FAC-	NO	<input type="checkbox"/>	<input type="checkbox"/>	
SEA-LAVENDER,CAROLINA	<i>Limonium carolinianum</i>	Perennial	[1,2],3	OBL	YES	<input type="checkbox"/>	<input type="checkbox"/>	
SEA-LAVENDER,NORTHERN	<i>Limonium nashii</i>	Perennial	[1,2],3	OBL	YES	<input type="checkbox"/>	<input type="checkbox"/>	
SEA-OATS	<i>Uniola paniculata</i>	Grass	[4,5,6]	FACU-	NO	<input type="checkbox"/>	<input type="checkbox"/>	
SEDGE,BEARDED	<i>Carex comosa</i>	Grass	[1,2],3	OBL	6"SATURATE	<input type="checkbox"/>	<input type="checkbox"/>	
SEDGE,BENT	<i>Carex styloflexa</i>	Grass	2,[3,4]	FACW-	YES	<input type="checkbox"/>	<input type="checkbox"/>	7-8
SEDGE,CAT-TAIL	<i>Carex typhina</i>	Grass	[2,3],4	FACW+	YES	<input type="checkbox"/>	<input type="checkbox"/>	5-8
SEDGE,CRESTED	<i>Carex cristatella</i>	Grass	[1,2],3,4	FACW	YES	<input type="checkbox"/>	<input type="checkbox"/>	
SEDGE,FESCUE	<i>Carex festucacea</i>	Grass	[3,4,5]	FAC	NO	<input type="checkbox"/>	<input type="checkbox"/>	4-6
SEDGE,FOX	<i>Carex vulpinoidea</i>	Grass	[1,2],3	OBL	SAT. 0-6"	<input type="checkbox"/>	<input type="checkbox"/>	
SEDGE,FRINGED	<i>Carex crinita</i>	Grass	[1,2],3	OBL	YES	<input type="checkbox"/>	<input type="checkbox"/>	
SEDGE,GRACEFUL	<i>Carex gracillima</i>	Grass	[4,5],6	FACU	NO	<input type="checkbox"/>	<input type="checkbox"/>	7
SEDGE,HOARY	<i>Carex canescens</i>	Grass	[1,2],3	OBL	YES	<input type="checkbox"/>	<input type="checkbox"/>	
SEDGE,INLAND	<i>Carex interior</i>	Grass	1,[2,3]	OBL	YES	<input type="checkbox"/>	<input type="checkbox"/>	5-8

Stormwater Plant List - Herbaceous Vegetation



COMMON	SCIENTIFIC	FORM	ZONE	INDICATOR	TOLERANCE			HARDINESS
					INUNDATION	POLLUTION	SALT	
SEDGE, LAKEBANK	<i>Carex lacustris</i>	Grass	[1,2],3	OBL	SAT. 0-2'	<input type="checkbox"/>	<input type="checkbox"/>	
SEDGE, LOOSE-FLOWERED	<i>Carex laxiflora</i>	Grass	[4,5,6]	FACU	NO	<input type="checkbox"/>	<input type="checkbox"/>	5-8
SEDGE, RETRORSE	<i>Carex retrorsa</i>	Grass	[2,3],4	FACW+	SAT. 0-6"	<input type="checkbox"/>	<input type="checkbox"/>	
SEDGE, SHALLOW	<i>Carex lurida</i>	Grass	[1,2],3	OBL	YES	<input type="checkbox"/>	<input type="checkbox"/>	5-8
SEDGE, SWAN'S	<i>Carex swanii</i>	Grass	[4,5,6]	FACU	NO	<input type="checkbox"/>	<input type="checkbox"/>	5-8
SEDGE, UPTIGHT	<i>Carex stricta</i>	Grass	[1,2],3	OBL	SAT.0-6"	<input type="checkbox"/>	<input type="checkbox"/>	
SEDGE, WOOLY	<i>Carex lanuginosa</i>	Grass	[1,2],3	OBL	SAT.0-6"	<input type="checkbox"/>	<input type="checkbox"/>	
SEDGE, YELLOW-FRUIT	<i>Carex annectens</i>	Grass	[2,3],4	FACW+	YES	<input type="checkbox"/>	<input type="checkbox"/>	
SEEDBOX	<i>Ludwigia x lacustris</i>	Annual	[1,2],3	OBL	YES	<input type="checkbox"/>	<input type="checkbox"/>	
SENNA, MARYLAND	<i>Cassia marilandica</i>	Groundcover	3,[4,5]	FAC+	SATURATED	<input type="checkbox"/>	<input type="checkbox"/>	
SKULLCAP	<i>Scutellaria churchilliana</i>	Perennial	[2,3],4	FACW	YES	<input type="checkbox"/>	<input type="checkbox"/>	
SOLOMON'S-SEAL, GREAT	<i>Polygonatum commutatum</i>	Perennial	[4,5,6]	FACU	NO	<input type="checkbox"/>	<input type="checkbox"/>	
SOLOMON'S-SEAL, SMALL	<i>Polygonatum biflorum</i>	Perennial	[4,5,6]	FACU	NO	<input type="checkbox"/>	<input type="checkbox"/>	
SPIKERUSH, BLUNT	<i>Eleocharis obtusa</i>	Grass	[1,2],3	OBL	0-6"	<input type="checkbox"/>	<input type="checkbox"/>	
SPIKERUSH, CREEPING	<i>Eleocharis palustris</i>	Grass	[1,2],3	OBL	SEASONAL	<input type="checkbox"/>	<input type="checkbox"/>	
SPIKERUSH, ENGELMANN'S	<i>Eleocharis engelmannii</i>	Grass	[2,3],4	FACW+	YES	<input type="checkbox"/>	<input type="checkbox"/>	
SPIKERUSH, SQUARE-STEM	<i>Eleocharis quadrangulata</i>	Grass	[1,2],3	OBL	0-1'	<input type="checkbox"/>	<input type="checkbox"/>	
SPRING BLUE EYE, MARY	<i>Collinsia verna</i>	Perennial	4,5,6	FAC-	NO	<input type="checkbox"/>	<input type="checkbox"/>	1-8
ST. JOHN'S-WORT, MARSH	<i>Triadenum fraseri</i>	Perennial	[1,2],3	OBL	YES	<input type="checkbox"/>	<input type="checkbox"/>	
STARWORT, MARSH	<i>Stellaria palustris</i>	Perennial	[5],6	FACU	NO	<input type="checkbox"/>	<input type="checkbox"/>	
STONECROP, ROCK	<i>Sedum pulchellum</i>	Perennial	[4,5,6]	FACU	NO	<input type="checkbox"/>	<input type="checkbox"/>	
STONECROP, ROSEROOT	<i>Sedum rosea</i>	Perennial	3,4,5,6	FACU	NO	<input type="checkbox"/>	<input type="checkbox"/>	

Stormwater Plant List - Herbaceous Vegetation

COMMON	SCIENTIFIC	FORM	ZONE	INDICATOR	TOLERANCE			HARDINESS
					INUNDATION	POLLUTION	SALT	
SWAMP MILKWEED	<i>Asclepias incarnata</i>	Perennial	2,3	OBL	SATURATED	<input type="checkbox"/>	<input type="checkbox"/>	3-8
SWAMP ROSE MALLOW	<i>Hibiscus moscheutos</i>	Perennial	2,3	OBL	0-3"	<input type="checkbox"/>	<input type="checkbox"/>	4-8
SWAMP SMARTWEED	<i>Polygonum coccineum</i>	Perennial	2,3,4	OBL	0-3'	<input type="checkbox"/>	<input type="checkbox"/>	2-8
SWAMP-LOOSESTRIFE,HAIRY	<i>Decodon verticillatus</i>	Perennial	[1,2],3	OBL	YES	<input type="checkbox"/>	<input type="checkbox"/>	
SWITCHGRASS	<i>Panicum virgatum</i>	Grass	2,[3,4],5	FAC	SEASONAL	<input type="checkbox"/>	<input type="checkbox"/>	
TREFOIL, BIRD'S-FOOT	<i>Lotus corniculatus</i>	Perennial	4,5,6	FACU-	NO	<input type="checkbox"/>	<input type="checkbox"/>	2-8
TURTLEHEAD,RED	<i>Chelone obliqua</i>	Perennial	[1,2],3	OBL	YES	<input type="checkbox"/>	<input type="checkbox"/>	
TURTLEHEAD,WHITE	<i>Chelone glabra</i>	Perennial	[1,2],3	OBL	YES	<input type="checkbox"/>	<input type="checkbox"/>	
VALERIAN,EDIBLE	<i>Valeriana edulis</i>	Perennial	[1,2],3	OBL	YES	<input type="checkbox"/>	<input type="checkbox"/>	
VERVAIN,BLUE	<i>Verbena hastata</i>	Perennial	2,3,4	FACW+	YES	<input type="checkbox"/>	<input type="checkbox"/>	
VIOLET,APPALACHIAN BLUE	<i>Viola appalachensis</i>	Perennial	[4,5],6	FACU	NO	<input type="checkbox"/>	<input type="checkbox"/>	
VIOLET,COASTAL	<i>Viola brittoniana</i>	Perennial	[3,4],5	FAC	NO	<input type="checkbox"/>	<input type="checkbox"/>	
VIOLET,COMMON BLUE	<i>Viola papilionacea</i>	Perennial	[3,4,5]	FAC	NO	<input type="checkbox"/>	<input type="checkbox"/>	
VIRGINIA WILD RYE	<i>Elymus virginicus</i>	Grass	2,[3,4]	FACW-	YES	<input type="checkbox"/>	<input type="checkbox"/>	
WATER SMARTWEED	<i>Polygonum amphibium</i>	Perennial	2,3	OBL	6"-Sat	<input type="checkbox"/>	<input type="checkbox"/>	2-8
WATER-CRESS,TRUE	<i>Nasturtium officinale</i>	Annual	[1,2],3	OBL	2"-1'	<input type="checkbox"/>	<input type="checkbox"/>	
WATER-LILY,PYGMY	<i>Nymphaea tetragona</i>	Perennial	[1,2],3	OBL	1-3'	<input type="checkbox"/>	<input type="checkbox"/>	
WATER-LILY,WHITE	<i>Nymphaea odorata</i>	Perennial	[1,2],3	OBL	1-3'	<input type="checkbox"/>	<input type="checkbox"/>	
WATER-LILY,WHITE	<i>Nymphaea tuberosa</i>	Perennial	[1,2],3	OBL	1-3'	<input type="checkbox"/>	<input type="checkbox"/>	
WATER-LILY,YELLOW/ SPATTERDOCK	<i>Nuphar advena/luteum</i>	Perennial	[1,2],3	OBL	1-3'	<input type="checkbox"/>	<input type="checkbox"/>	
WHORLED COREOPSIS	<i>Coreopsis verticillata</i>	Perennial	[2,3],4	FACW	YES	<input type="checkbox"/>	<input type="checkbox"/>	3-8
WIDGEON-GRASS	<i>Ruppia maritima</i>	Grass	[1,2],3	OBL	1' MIN	<input type="checkbox"/>	<input checked="" type="checkbox"/>	

Stormwater Plant List - Herbaceous Vegetation

COMMON	SCIENTIFIC	FORM	ZONE	INDICATOR	TOLERANCE			HARDINESS
					INUNDATION	POLLUTION	SALT	
WILD-LILY-OF-THE-VALLEY	<i>Maianthemum canadense</i>	Perennial	[4,5],6	FAC-	NO	<input type="checkbox"/>	<input type="checkbox"/>	
WITCHGRASS,HELLER'S	<i>Dichanthelium oligosanthes</i>	Grass	[4,5,6]	FACU	NO	<input type="checkbox"/>	<input type="checkbox"/>	
WITCHGRASS,NEEDLE-LEAF	<i>Dichanthelium aciculare</i>	Grass	[4,5,6]	FACU	NO	<input type="checkbox"/>	<input type="checkbox"/>	
WOOD-REEDGRASS,SLENDER	<i>Cinna latifolia</i>	Grass	[2,3,4]	FACW	YES	<input type="checkbox"/>	<input type="checkbox"/>	
WOODRUSH,COMMON	<i>Luzula multiflora</i>	Grass	[4,5,6]	FACU	NO	<input type="checkbox"/>	<input type="checkbox"/>	
WOOL-GRASS	<i>Scirpus cyperinus</i>	Grass	[2,3],4	FACW+	SEASONAL	<input type="checkbox"/>	<input type="checkbox"/>	

## Section A.5 References

The following is a list of resources used in compiling these guidelines and the list of plant materials:

Art, Henry W. 1986. A Garden of Wildflowers, 101 Native Species and How to Grow Them. Storey Communications, Inc. Pownal, VT.

Brown, Melvin L. and Brown, Russell G. 1984. Herbaceous Plants of Maryland. Port City Press. Baltimore, MD.

Brown, Melvin L. and Brown, Russell G. 1992. Woody Plants of Maryland. Port City Press. Baltimore, MD.

Clausen, Ruth Rogers and Ekstrom, Nicolas, H. 1989. Perennials for American Gardens. Random House. New York, NY.

Dirr, Michael A. 1990. Manual of Woody Landscape Plants, Their Identification, Ornamental Characteristics, Culture, Propagation, and Uses. 4<sup>th</sup> Edition. Stipes Publishing Company. Champaign, IL.

Engineering Technology Associates Inc. and Biohabitats, Inc. (ETA&B). 1993. Design Manual for Use of Bioretention in Stormwater Management. Prince Georges County Dept. of Environmental Resources. Upper Marlboro, MD.

Greenlee, John. 1992. The Encyclopedia of Ornamental Grasses, How to Grow and Use Over 250 Beautiful and Versatile Plants. Rodale Press. Emmaus, PA.

Hill, Steven R. and Duke, Peggy K. 1985-86. 100 Poisonous Plants of Maryland. Bulletin No. 314. University of Maryland Cooperative Extension Services. Ellicott City, MD.

Longenecker, G. 1983. Woody Plant List for West Virginia. Landscape Architecture Department, Division of Resource Management, West Virginia University. Morgantown, WV.

Maryland Department of the Environment. 1994. Water Management Administration and Maryland Soil Conservation Service. 1994 Maryland Standards and Specifications for Soil Erosion and Sediment Control. Baltimore, MD.

Maryland Natural Heritage Program, Department of Natural Resources. 1994. Invasive and Exotic Plants of Wetlands and Floodplains in Maryland. Maryland Natural Heritage Program, Department of Natural Resources, Tawes State Office Building. Annapolis, MD.

Maryland Natural Heritage Program, Department of Natural Resources. 1994. Rare Species of Submerged Aquatic Vegetation in Maryland. Maryland Natural Heritage Program, Department of Natural Resources, Tawes State Office Building. Annapolis, MD.

Miles, B. 1996. Wildflower Perennials for Your Garden, A Detailed Guide to Years of Bloom from America's Native Heritage. Stackpole Books. Mechanicsburg, PA.

Newcomb, L. 1977. Newcomb's Wildflower Guide. Little Brown and Company. Boston, MA.

Reed, Porter B. Jr. 1998. National List of Plant Species that Occur in Wetlands: Northeast (Region 1), For National Wetlands Inventory. U.S. Fish and Wildlife Service, U.S. Department of the Interior, Washington, D.C.

Schueler, Thomas R. 1987. Controlling Urban Runoff: A Practical Manual for Planning and Designing Urban BMP's. Department of Environmental Programs Metropolitan Washington Council of Governments, Metropolitan Information Center. Washington, D.C.

Schueler, Thomas R. 1996. Design of Stormwater Wetland Systems: Guidelines for Creating Diverse and Effective Stormwater Wetland Systems in the Mid-Atlantic Region. Department of Environmental Programs Metropolitan Washington Council of Governments, Metropolitan Information Center. Washington, D.C.

Schueler, Thomas R. and Claytor, Richard A. 1997. Design of Stormwater Filtering Systems: Appendix B and C. Chesapeake Bay Consortium. Silver Spring, MD.

The Pennsylvania State University, College of Agriculture, Cooperative Extension Service. Weed Identification. File No. IVC9 10M386, U. Ed. 85-439 and File No. IVC9 10M587 U.Ed. 86-356. The Pennsylvania State University, College of Agriculture, Cooperative Extension Service. University Park, PA.

Thunhorst, Gwendolyn A. 1993. Wetland Planting Guide for the Northeastern United States: Plants for Wetland Creation, Restoration, and Enhancement, Environmental Concern, Inc. St. Michael, MD.

Tiner, Ralph W. Jr. 1988. Field Guide to Non-Tidal Wetland Identification. U.S. Fish and Wildlife Service and Maryland Department of Natural Resources and Maryland Geological Survey. Annapolis, MD.

**Appendix**

**B.1**

**NRCS-MD Code No. 378 Pond Standards/Specifications**

USDA  
NATURAL RESOURCES  
CONSERVATION SERVICE  
MARYLAND

CONSERVATION PRACTICE  
STANDARD

**POND**

CODE 378  
(Reported in No.)

**DEFINITION**

A water impoundment made by constructing a dam or an embankment or by excavating a pit or dugout.

In this standard, ponds constructed by the first method are referred to as embankment ponds, and those constructed by the second method are referred to as excavated ponds. Ponds constructed by both excavation and the embankment methods are classified as embankment ponds if the depth of water impounded against the embankment at the principal spillway storm design high water elevation is 3 feet or more (See Table 1).

This 3 feet shall be measured from the low point on the upstream toe of the embankment to the design high water.

**PURPOSE**

To provide water for livestock, fish and wildlife, recreation, fire control, crop and orchard spraying, and other related uses, and to maintain or improve water quality. This standard also applies to stormwater management ponds.

**CONDITIONS WHERE PRACTICE  
APPLIES**

**General** - This practice applies where it is determined that stormwater management, water

supply, or temporary storage is justified and it is feasible and practicable to build a pond which will meet local and state law requirements.

This standard establishes the minimum acceptable quality for the design and construction of ponds if:

1. Failure of the dam will not result in loss of life; in damage to homes, commercial or industrial buildings, main highways, or railroads; or interruption of the use or service of public utilities.
2. The product of the storage times the effective height of the dam is less than 3,000. Storage is the volume, in acre-feet, in the reservoir below the elevation of the crest of the emergency spillway.

The effective height of the dam is the difference in elevation, in feet, between the emergency spillway crest and the lowest point on a profile taken along the centerline of the dam, excluding the cutoff trench. If there is no emergency spillway, the top of the dam becomes the upper limit for determining the storage and the effective height.

3. For dams in rural areas, the effective height of the dam (as defined above) is 35 feet or less and the dam is hazard class "a". For dams in urban areas, the effective height of the dam is 20 feet or less and the dam is hazard class "a".

Ponds exceeding any of the above conditions shall be designed and constructed according to the requirements of Technical Release 60.

**Exemptions** - Soil Conservation District small pond approval is not required for small class "a" structures where the following exists:

1. Ponds or other structures have less than four (4) feet of embankment, or
2. The storage at emergency spillway design high water elevation according to Table 1 does not exceed 40,000 cubic feet, and the

Conservation practice standards are reviewed periodically, and updated if needed. To obtain the current version of this standard, contact the Natural Resources Conservation Service

height of the embankment is 6 feet or less.

The height of the embankment shall be measured from the top of the dam to the lowest point of excavation, excluding the cutoff trench, along the centerline of the dam.

In addition, an embankment pond that meets the criteria below shall be considered an excavated pond and is also exempt from small pond approval.

1. The calculation of  $10H+20=L$ , where H=height from the pond bottom to the top of the dam, is provided, and
2. The projection of L horizontally downstream from the pond bottom is below the existing or proposed ground, and
3. The existing or proposed downstream ground slope within the projection of L is less than 10% at any point.

The review and design of such class "a" structures shall be based on sound engineering judgment assuring a stable outfall for the ten (10) year, 24-hour storm event.

**Site Conditions** - Site Conditions shall be such that runoff from the design storm can be safely passed through (1) a natural or constructed emergency spillway, (2) a combination of a principal spillway and an emergency spillway, or (3) a principal spillway.

**Drainage Area** - The drainage area above the pond must be protected against erosion to the extent that expected sedimentation will not shorten the planned effective life of the structure.

For ponds whose primary purpose is to trap sediment for water quality, adequate storage should be provided to trap the projected sediment delivery from the drainage area for the life of the pond.

If the intent is to maintain a permanent pool, the drainage area should be at least 4 acres for each acre-foot of permanent storage. These recommendations may be reduced if a dependable source of ground water or diverted surface water contributes to the pond. The water quality shall be suitable for its intended use.

**Soils Investigation** - A soils investigation is required on all ponds. As a minimum it shall include information along the centerline of the proposed dam, in the emergency spillway location, and the planned borrow area. The type of equipment used and the extent of the investigation will vary from site to site. All investigations shall be logged using the Unified Soil Classification System.

**Road Embankments** - Where road embankments are being designed to impound a specific volume of water, either as a permanent pool or temporary stormwater storage, special design and evaluation criteria may be required as determined by Appendix B.

## **CONSIDERATIONS**

**Water Quantity** - The following items should be considered for water quantity:

1. Effects upon components of the water budget, especially effects on volumes and rates of runoff, infiltration, evaporation, transpiration, deep percolation, and ground water recharge.
2. Variability of effects caused by seasonal or climatic changes.
3. Effects on the downstream flows or aquifers that could affect other water uses or users.
4. Potential for multiple use.
5. Effects on the volume of downstream flow to prohibit undesirable environmental, social or economic effects.

**Water Quality** - The following items should be considered for water quality:

1. Effects on erosion and the movement of sediment, pathogens, and soluble and sediment attached substances that are carried by runoff.
2. Effects on the visual quality of on-site and downstream water resources.
3. Short-term and construction-related effects of this practice on the quality of downstream water courses.



4. Effects of water level control on the temperatures of downstream waters to prevent undesired effects on aquatic and wildlife communities.
5. Effects on wetlands and water-related wildlife habitats.
6. Effects of water levels on soil nutrient processes such as plant nitrogen use or denitrification.
7. Effects of soil water level control on the soil chemistry, soil water, or downstream water.
8. Potential for earth moving to uncover or redistribute sulfidic bearing soils.

## CRITERIA

### Embankment Ponds

**Structure Hazard Classification** - Documentation of the classification of dams is required. Documentation is to include but is not limited to location and description of dam, configuration of the valley, description of existing development (houses, utilities, highways, railroads, farm or commercial buildings, and other pertinent improvements), potential for future development, and recommended classification. It is also to include results obtained from breach routings, if breach routings are used as part of the classification process. The class ("a", "b", and "c") as contained in this document is related to the potential hazard to life and property that might result from a sudden major breach of the earth embankment. Structure classification and land use for runoff determination must take into consideration the anticipated changes in land use throughout the expected life of the structure. The classification of a dam is the responsibility of the designer, and subject to review and concurrence of the approving authority.

The classification of a dam is determined only by the potential hazard from failure, not by the criteria. Classification factors in the National Engineering Manual, as supplemented, are given below:

Class "a" - Structures located in rural, agricultural or urban areas dedicated to remain in flood tolerant usage where failure may dam-

age non-inhabited buildings, agricultural land, floodplains or county roads.

Class "b" - Structures located in rural, agricultural, or urban areas where failure may damage isolated homes, main highways or minor railroads or cause interruption of use or service of relatively important public utilities.

Class "c" - Structures located where failure may cause loss of life or serious damage to homes, industrial and commercial buildings, important public utilities, main highways, or railroads.

"Rural areas" is defined as those areas in which residents live on farms, in unincorporated settlements, or in incorporated villages or small towns. It is where agriculture, including woodland activities, and extractive industries, including seafood harvesting, provides the primary employment base for residents and where such enterprises are dependent on local residents for labor.

Non-rural areas shall be classified as urban.

**Peak Breach Discharge Criteria** - Breach routings are used to help delineate the area potentially impacted by inundation should a dam fail and can be used to aid dam classification. The breach hydrograph is the outflow hydrograph attributed to the sudden release of water in reservoir storage. This is due to a dam breach during non-storm conditions.

Stream routings made of the breach hydrograph are to be based upon topographic data and hydraulic methodologies mutually consistent in their accuracy and commensurate with the risk being evaluated.

The minimum peak discharge of the breach hydrograph, regardless of the techniques used to analyze the downstream inundation area, is as follows:

$$Q_{\max} = 3.2 H_w^{2.5} \text{ where,}$$

$Q_{\max}$  = the peak breach discharge, cfs.

$H_w$  = depth of water at the dam at the time of failure, feet. This is measured to

the crest of the emergency spillway or to design high water, if no emergency spillway exists. Use “nonstorm” conditions downstream of the dam.

Where breach analysis has indicated that only overtopping of downstream roads will occur, the following guidelines will be used:

<u>Class</u>	<u>Depth of Flow (d) ft.</u>
“a”	$d \leq 1.5$
“b” & “c”	$d > 1.5$

Use and importance of the roadway shall be considered when making a classification.

**Hydrology** - Principal and emergency spillways will be designed within the limitations shown on TABLE 1. The storm duration used shall be 24 hours except where TR-60 is specified. The pond shall be designed to safely pass the base flow along with volume and peak rates of runoff from design storms, specified in Table 1. All storm water management ponds shall be designed using urban criteria. This can be done by using principal and emergency spillways. The following shall be used to determine runoff rates and volumes:

1. NRCS “Engineering Field Handbook, Part 650” or;
2. NRCS, NEH, Section 4, Hydrology” or;
3. NRCS, TR-55, “Urban Hydrology for Small Watersheds” or;
4. NRCS, TR-20, “Computer Program for Project Formulation” or,
5. Computer programs using NRCS hydrology methods with identifiable inputs and outputs as approved by the reviewing agency.

**Earth Embankment**

**Top Width** - The minimum top width of the dam is shown in Table 2. When the embankment top is to be used as a public road, the minimum width is to be 16 feet for one-way and 26 feet for two-way traffic. If the embankment is to be used

for infrequent vehicle crossings, the minimum top width shall be 10 feet. Guardrails or other safety measures are to be used where necessary and are to meet the requirements of the responsible road authority.

**Side Slopes** - The combined upstream and downstream side slopes of the settled embankment shall not be less than five horizontal to one vertical (5:1) with neither slope steeper than 2:1. If the dam is used as a road crossing with a top width greater than 26 feet, then the combined side slopes of the settled embankment shall not be less than 4 horizontal to one vertical (4:1) with neither slope steeper than 2:1. Slopes must be designed to be stable in all cases, even if flatter side slopes are required.

**Earth Cuts** - If cuts in an existing fill or in natural ground are required for the rehabilitation of an existing pond spillway or the construction of a new pond, the slope of the bonding surfaces between the existing material in place and the fill to be placed shall not be steeper than a ratio of two horizontal to one vertical (2:1).

**Foundation Cutoff** - A cutoff trench of relatively impervious material shall be provided under the entire length of the dam and shall be located at or upstream from the centerline of the dam. The cutoff trench shall have a bottom width adequate to accommodate the equipment used for excavation, backfill and compaction operations, with the minimum width being 4 feet, and shall have side slopes no steeper than one horizontal to one vertical. Minimum depth shall be 4 feet.

**Impervious Core** - Any impervious core within the embankment shall be located at or upstream from the centerline of the dam, and shall extend up the abutments to the 10-year water surface elevation. The impervious core shall extend vertically from the cutoff trench up to the 10-year water surface elevation throughout the embankment.

**Seepage Control** - Seepage control is to be included: (1) if pervious layers are not intercepted by the cutoff; (2) if seepage from the abutments may create a wet embankment; (3) if the phreatic line intersects the downstream slope; or (4) if special conditions require drainage to insure a stable dam. The phreatic line shall be drawn on

a 4:1 slope starting on the inside slope at the normal pool elevation. For stormwater management ponds, normal pool shall be considered as the 10-year water surface elevation.

Seepage may be controlled by (1) foundation abutment or embankment drains; (2) reservoir blanketing; or (3) a combination of these measures. Foundation drains may control seepage encountered in the cutoff trench during construction. These drains must be located downstream of the dam centerline and outside the limits of the proposed cutoff trench. All drains must be designed according to the section Principal Spillway, Conduit Piping and Seepage Control.

**Wave Erosion Protection** - Where needed to protect the face of the dam, special wave protection measures such as a bench, rock riprap, sand-gravel, soil cement or special vegetation shall be provided. (Reference NRCS Technical Releases 56 & 69)

**Freeboard** - The top elevation of the settled embankment shall be determined in accordance with minimum criteria established in Table 1

**Allowance for Settlement** - The design height of the dam shall be increased by the amount needed to insure that the design top of fill elevation will be maintained after all settlement has taken place. This increase shall not be less than 5 percent, except where detailed soil testing and lab analyses indicate a lesser amount is adequate.

### **Principal Spillway**

**Capacity** - A conduit, with needed appurtenances, shall be placed under or through the dam, except where a weir type structure is used. The minimum capacity of the principal spillway shall be that required in Table 1.

**Crest Elevation of Inlet** - The crest elevation of the principal spillway shall be no less than 1.0 foot below the crest of the emergency spillway. The crest elevation is the invert elevation of the lowest opening 6 inches or larger in any direction.

The inlet or riser size for the pipe drops shall be such that the flow through the structure goes from weir-flow control to pipe-flow control without going into orifice-flow control in the

riser. The inlets and outlets shall be designed and analyzed to function satisfactorily for the full range of flow and hydraulic head anticipated.

The riser shall be analyzed for flotation assuming all orifices and pipes are plugged. The factor of safety against flotation shall be 1.2 or greater.

**Pipe Conduits** - Pipe conduits under or through the dam shall meet the following requirements:

1. All pipes shall be circular in cross section except for cast-in-place reinforced concrete box culverts.
2. Pipe shall be capable of withstanding the external loading without yielding, buckling, or cracking.
3. Pipe strength shall be not less than those shown on Tables 3, 4 and 5 for corrugated steel, aluminum, and plastic pipes and applicable ASTM's for other materials.
4. Where inlet or outlet flared sections are used, they shall be made from materials compatible with the pipe.
5. All pipe joints shall be made watertight by the use of flanges with gaskets, coupling bands with gaskets, bell and spigot ends with gaskets, or by welding. See Construction Specifications for details.
6. The joints between sections of pipe shall be designed to remain watertight after joint rotation and elongation caused by foundation consolidation.

The capacity of the pipe conduit shall be adequate to discharge long duration, continuous or frequent flows without flow through the emergency spillway. The diameter of the pipe shall be not less than 6 inches.

For dams 20 feet or less in effective height, the following pipe materials are acceptable: cast-iron, ductile iron, steel, corrugated steel or aluminum, concrete with rubber gaskets, plastic, and cast-in-place reinforced concrete box culverts. Plastic pipe that will be exposed to direct sunlight should be made of ultraviolet resistant materials and protected by coating or shielding. Connections of pipe to less flexible pipe or struc-

tures must be designed to avoid stress concentrations that could rupture the pipe.

For dams over 20 feet in effective height, conduits are to be reinforced concrete pipe, cast-in-place reinforced concrete box culverts, corrugated steel, ductile iron, welded steel or aluminum pipe. The maximum height of fill over any principal spillway steel, aluminum, or plastic pipe must not exceed 25 feet.

Concrete pipe shall have a concrete cradle extending up the sides of the pipe at least 50% of its outside diameter with minimum thickness of 6 inches. Where a concrete cradle is not needed for structural reasons, flowable fill may be used as described in the CONSTRUCTION SPECIFICATIONS section of this standard. Gravel bedding is not permitted. Cantilever outlet sections, if used, shall be designed to withstand the cantilever load. Pipe supports shall be provided when needed. Other suitable devices such as plunge basin, stilling basin, impact basin, or rock riprap spreader should be used to provide a safe outlet. Cathodic protection is to be provided for welded steel and corrugated steel pipe where the need and importance of the structure warrant. Cathodic protection should normally be provided for corrugated steel pipe where the saturated soil resistivity is less than 4,000 ohm-cm or the pH is lower than 5. The National Handbook of Conservation Practices, Irrigation Water Conveyance, Steel Pipeline Standard (430-FF), provides criteria for cathodic protection of welded steel pipes.

***Multiple Conduits*** - Where multiple conduits are used, there shall be sufficient space between the conduits and the installed anti-seep collars to allow for backfill material to be placed between the conduits by the earth moving equipment and for easy access by hand operated compaction equipment. This distance between conduits shall be equal to or greater than half the pipe diameter but not less than 2 feet.

***Conduit Piping and Seepage Control*** - Seepage along pipe conduit spillways extending through the embankment shall be controlled by use of (1) anti-seep collars, or (2) filter and drainage diaphragm. Seepage control will not be required on pipes 6 inches in diameter or less.

Anti-seep collars shall be installed around all conduits through earth fills according to the following criteria:

1. Sufficient collars shall be placed to increase the seepage length along the conduit by a minimum of 15 percent of the pipe length located within the saturation zone.
2. The assumed normal saturation zone shall be determined by projecting a line at a slope (4) horizontal to (1) vertical from the point where the normal water elevation meets the upstream slope to a point where this line intersects the invert of the pipe conduit or bottom of the cradle, whichever is lower. For Stormwater Management ponds, the phreatic line starting elevation shall be the 10-year water elevation.
3. Maximum collar spacing shall be 14 times the required projection above the pipe. The minimum collar spacing shall be 5 times the required minimum projection.
4. Anti-seep collars should be placed within the saturated zone. In cases where the spacing limit will not allow this, at least one collar will be in the saturated zone.
5. All anti-seep collars and their connections to the conduit shall be watertight and made of material compatible with the conduit.
6. Collar dimensions shall extend a minimum of 2 feet in all directions around the pipe.
7. Anti-seep collars shall be placed a minimum of two feet from pipe joints except where flanged joints are used.
8. For pipes with concrete cradles, the projection shall be measured from the cradle.

Filter and drainage diaphragms are always recommended, but are required when the following conditions are encountered:

1. The pond requires design according to TR-60.
2. Embankment soils with high piping potential such as Unified Classes GM, SM, and ML.

Filter and drainage diaphragms shall be designed in accordance with procedures from NRCS TR-60, Earth Dams and Reservoirs, Section 6, Principal Spillways, as described below.

The drainage diaphragm shall usually consist of sand, meeting the fine concrete aggregate requirements (ASTM C-33). A design analysis shall be made using Part 633 of the National Engineering Manual, Chapter 26, Gradation Design of Sand and Gravel Filters.

The drainage diaphragm shall be a minimum of 3 ft thick and extend vertically upward and horizontally at least three times the conduit outside diameter or the width of the cradle, whichever is greater except that:

1. The vertical extension need be no higher than the maximum potential reservoir water level, and
2. The horizontal extension need be no further than 5 feet beyond the sides and slopes of any excavation made to install the conduit.
3. The minimum soil cover over any portion of the filter-drainage diaphragm measured normal to the nearest embankment surface shall be at least 2 feet.

It shall extend vertically downward at least 2 ft beneath the conduit outside diameter or bottom of the cradle, whichever is greater. The drainage diaphragm shall be located immediately downstream of the cutoff trench, approximately parallel to the centerline of the dam but no further upstream than the centerline of the dam.

The drainage diaphragm shall outlet at the embankment downstream toe, preferably using a drain backfill envelope continuously along the pipe to where it exits the embankment. Protecting drain fill from surface erosion will be necessary.

It is required that the outlet for the filter diaphragm is sized to safely discharge the design flow. Where a drain backfill envelope is used as the outlet, it is recommended that it be designed so the hydraulic head does not exceed the depth of the drain outlet. The exposed area of the drain outlet must also be protected from external attack such as surface erosion and slope instability due to horizontal seepage pressures. A weighted

toe cover such as riprap can be effective if protected with a properly designed filter between the sand drain material and the riprap cover.

If pipe drain outlets are used, consideration must be given to the structural design of the conduit in resisting external loading and the design life of the pipe must be consistent with the design life of the dam and physical conditions of the site. Also, the pipe must be designed for capacity and size of perforations as outlined in NEH Part 633, Chapter 26 and Soil Mechanics Note 3. If the pipe corrodes, is crushed by exterior loading, or is otherwise damaged, the outlet of the filter diaphragm is lost and a piping failure may occur.

The design quantity (Q) used to size the outlet can be calculated by Darcy's Law,  $Q = kiA$  where:

$k$  = permeability of the embankment or drain outlet material (ft/day)

$i$  = hydraulic gradient where  $i = h/l$

$h$  = head differential (ft)

$l$  = seepage path (ft)

$A$  = area of flow (diaphragm or outlet) (ft<sup>2</sup>)

**Anti-vortex Devices** - Drop inlet spillways are to have adequate anti-vortex devices. Splitter type anti-vortex devices shall be placed in line with the barrel. An anti-vortex device is not required if weir control is maintained in the riser through all flow stages.

**Trash Racks** - All pipe and inlet structures shall have a trash rack. Openings for trash racks shall be no larger than 1/2 of the barrel conduit diameter, but in no case less than 6 inches.

Flush grates for trash racks are not acceptable. Inlet structures that have flow over the top shall have a non-clogging trash rack such as a hood-type inlet extending a minimum of 8 inches below the weir openings, which allows passage of water from underneath the trash rack into the riser.

For inlet structures with solid covered tops, the bottom of the cover slab must be set at an eleva-

tion to prevent orifice flow control before pipe flow control governs.

Low stage releases, where the opening is larger than 6 inches, shall have a non-clogging trash rack with openings no larger than half the low flow dimension.

For all low stage releases 6 inches or smaller in any direction, the emergency spillway design storm shall be routed assuming the release has failed, using storage and discharge only above the elevation of the next opening larger than 6 inches in all directions. This design storm routing shall not overtop the dam.

**Drain Pipe** - A pipe with a suitable valve shall be provided to drain the pool area, where needed for proper pond management. The principal spillway conduit may serve as a pond drain, when so located, to accomplish this function.

**Water Supply Pipes or Utilities** - All pipes through the dam shall have an inside diameter of not less than 1 1/4 inches. Pipes / utilities not parallel to the axis of the dam shall meet all principal spillway requirements (i.e. filter diaphragm, embankment soils, etc.). Pipes / utilities parallel to the axis of the dam shall be constructed with no granular bedding.

### **Earth Emergency Spillways**

Emergency spillways are provided to convey large flood flows safely past earth embankments. An emergency spillway must be provided for each dam, unless the principal spillway is large enough to pass the routed design hydrograph peak discharge and any trash without overtopping the dam. The only design that may be utilized without an emergency spillway is: a principal spillway with a cross-sectional area of 3 square feet or more and an inlet that will not clog, such as a hood-type inlet which allows passage of water from underneath the trash rack into the riser.

**Capacity** - The minimum capacity of emergency spillways shall be that required to pass the peak flow expected from a design storm of the frequency and duration shown in Table 1 less any reduction creditable to conduit discharge and detention storage.

The emergency spillway shall (1) safely pass the storm design peak or (2) the storm runoff shall be routed through the reservoir. The routing shall start with the water surface at the elevation of the crest of the principal spillway, or at the water surface after 10 days drawdown, whichever is higher. The 10-day drawdown shall be computed from the crest of the emergency spillway or from the elevation that would be attained had the entire design storm been impounded, whichever is lower. Emergency spillways are to provide for passage of the design flow at a non-erosive velocity to a point downstream where the dam will not be endangered.

**Component Parts** - Earth spillways are open channels and usually consist of an inlet channel, level section, and an exit channel. The minimum difference in elevation between the crest of the emergency spillway and the settled top of dam shall be 2.0 feet.

**Cross-Section** - Earth spillways shall be trapezoidal and shall be located in undisturbed earth. The side slopes shall be stable for the material in which the spillway is to be constructed, but not steeper than 2:1. The emergency spillway shall have a bottom width of not less than 8 feet.

The inlet channel may be curved to fit existing topography; however, it should be flared to allow unrestricted flow to the level section. The level section should be located as near the centerline of dam as possible. The level section shall be 25 feet in length, and shall be rectangular or square.

Exit channel centerline shall be perpendicular to the level section downstream edge and must be straight for a distance beyond the downstream toe, so that discharges will not reach the earth embankment. The grade of the exit channel shall fall within the range established by discharge requirement and permissible velocities.

The crest of any "token" spillway will be located at or above the 100-year storm elevation in undisturbed earth and have a minimum depth of one foot and bottom width of 8 feet.

**Permissible Velocities** - Earth spillways shall be designed for non-erosive velocities through the control section and to a point downstream where the dam will not be endangered. The maximum permissible velocity for the grass and grass mix-

ture to be used shall be selected from Table 6. Velocities exceeding these values will require use of linings other than vegetation.

**Infiltration / Water Quality Basins** – Ponds, either excavated or embankment, that are designed solely for infiltration or as water quality basins will have an emergency spillway. The capacity of the spillway will be determined by the following procedure:

Pass the routed 100-Year Storm with 1 foot of freeboard to the top of dam elevation. Routing will begin at the emergency spillway crest.

### **Structural Emergency Spillways**

Chutes or drops, when used for principal spillways or principal-emergency or emergency spillways, shall be designed in accordance with the principals set forth in the National Engineering Handbook, Section 5 “Hydraulics”; Section 11 “Drop Spillways”; and Section 14 “Chute Spillways”. The minimum capacity of a structural spillway shall be that required to pass the peak flow expected from a design storm of the frequency and duration shown in Table 1 less any reduction creditable to conduit discharge and detention storage.

### **Visual Resource Design**

The visual design of ponds shall be carefully considered in areas of high public visibility and those associated with recreation. The underlying criterion for all visual design is appropriateness. The shape and form of ponds, excavated material, and plantings are to relate visually to their surroundings and to their functions.

The embankment may be shaped to blend with the natural topography. The edge of the pond should be shaped so that it is generally curvilinear rather than rectangular. Excavated material shall be shaped so that the final form is smooth, flowing, and fitting to the adjacent landscape rather than angular geometric mounds. If feasible, islands may be added for visual interest and to attract wildlife.

### **Trees and Shrubs**

**Non-Roadway Embankments** - Trees and/or shrubs will not be allowed on any embankment,

will not be allowed within the buffer zone (15 feet from the toe of the dam), and will not be allowed within a 25-foot radius around the inlet structure.

**Roadway Embankments** - Trees and/or shrubs will not be allowed on any embankment, except for dry stormwater management structures that will be utilized as a roadway under all the following conditions:

1. Plantings may only be on top of the dam along the roadway and/or sidewalks.
2. The top of the dam shall have a minimum of 50-foot top width.
3. Plantings will not be allowed on the side slopes of the embankment.
4. Plantings will not be allowed within the buffer zone (15 feet from the toe of the dam).
5. Plantings will only be shallow rooted (roots less than 3’ deep) trees or shrubs.
6. The pond is a “dry” structure (normal pool not exceeding 18 inches).
7. A landscape plan showing type and location of planting must be prepared by a Landscape Architect certifying shallow rooted plants (roots less than 3’ deep) under mature conditions.
8. A minimum of 3 feet freeboard above the 100-year water surface elevation must be maintained.
9. The structure is a low hazard (Class “a”) pond.

### **Safety**

Special considerations should be made for safety and access during the design of a pond. Measures to be considered may include fencing, slope benching, access roads, flattened side slopes, etc. When fencing a structure, the fence will be located so it will not interfere with the operation of the emergency spillway.

### **Excavated Ponds**

**General** - Excavated ponds that create a failure potential through a constructed or created embankment will be designed as embankment ponds. Excavated ponds that include a pipe or weir outlet control system for urban stormwater management shall be designed using the principal and emergency spillway hydrologic criteria for Embankment Ponds, Table 1.

**Side Slopes** - Side slopes of excavated ponds shall be such that they will be stable and shall not be steeper than 1 horizontal to 1 vertical. Flatter slopes are to be utilized where safety for children, livestock watering, etc. is a design factor.

**Perimeter Form** - Where the structures are used for recreation or are located in high public view, the perimeter or edge should be shaped to a curvilinear form.

**Inlet Protection** - When the excavated pond is a bypass type and water is being diverted from a stream, the minimum size inlet line shall be a 4-inch diameter pipe. All state laws concerning water use and downstream rights shall be strictly adhered to.

Where surface water enters the pond in a natural or excavated channel, the side slope of the pond shall be protected against erosion.

**Outlet Protection** - An excavated pond with a low embankment (combination excavation / embankment pond) shall be designed to ensure a stable outfall for the 10-year, 24-hour frequency storm.

**Placement of Excavated Material** - The material excavated from the pond shall be placed in one of the following ways so that its weight will not endanger the stability of the pond side slopes and where it will not be washed back into the pond by rainfall:

1. Uniformly spread to a height not exceeding 3 feet with the top graded to a continuous slope away from the pond;
2. Uniformly placed or shaped reasonably well with side slopes no steeper than 2 to 1. The excavated material will be placed at a dis-

tance equal to the depth of the pond, but not less than 12 feet from the edge of the pond;

3. Shaped to a designed form that blends visually with the landscape;
4. Used for low embankment and leveling; or
5. Hauled away.

### **Reservoir Area for Wet Ponds**

For most ponds, the topography of the site shall permit storage of water at a depth and volume that ensures a dependable supply, considering beneficial use, sedimentation, season of use, and evaporation and seepage losses. Soils in the reservoir shall be impervious enough to minimize seepage losses or shall be of a type that sealing is practical.

Excavation and shaping required to permit the reservoir area to suitably serve the planned purpose shall be included in the construction plans.

Reservoirs designed specifically for fish production or wildlife management shall follow design criteria in the standards and specifications for Fish Pond Management (MD-399) and Wildlife Wetland Habitat Management (MD-644), as appropriate.



**TABLE 1****HYDROLOGIC CRITERIA FOR PONDS**

Structure Class	Storage Height Product <sup>1</sup>	Watershed Area (Acres)	Height To Emergency Spwy Crest (Feet)	Normal Surface Area (Acres)	Spillway Capacity <sup>5</sup>				Freeboard <sup>6</sup> Rural & Urban
					Principal <sup>2</sup>		Emergency <sup>3,4</sup>		
					Rural	Urban	Rural	Urban	
"c" & "b"	Any	Any	Any	Any	TR 60	TR 60	TR 60	TR 60	TR 60
"a"	3,000 or more	Any	Any	Any	TR 60	TR 60	TR 60	TR 60	TR 60
"a"	Less than	320 and Larger	>20 - 35	≥12	25 YR	TR 60	100 YR	100 YR	2.0' above E.S. Design Storm
			≤20	≥12	10 YR	25 YR	100 YR	100 YR	
			<15	<12	5 YR	10 YR	50 YR	100 YR	
	to	100	>20 - 35	≥12	10 YR	TR 60	100 YR	100 YR	2.0' above E.S. Design Storm
			≤20	≥12	5 YR	10 YR	50 YR	100 YR	1.0' above E.S. Design Storm
			<15	<12	2 YR	5 YR	25 YR	100 YR	1.0' above E.S. Design Storm
	3,000	Less Than 100	>20 - 35	≥12	5 YR	TR 60	50 YR	100 YR	1.0' above E.S. Design Storm
			≤20	≥12	2 YR	5 YR	25 YR	100 YR	
			<15	<12	10% of 25 YR Peak	5 YR	25 YR	100 YR	

## NOTES

- 1) The storage is defined as the original capacity of the reservoir in acre-feet at the elevation of the crest of the emergency spillway. The effective height is the difference in elevation in feet between the emergency spillway crest and the lowest point on a profile taken along the centerline of the dam, excluding the cutoff trench. If there is no emergency spillway, this height shall be to the top of the dam.
- 2) Principal - minimum storm to be contained below the crest of the emergency spillway including any combination of temporary storage and principal spillway discharge.
- 3) Emergency - minimum storm used to proportion the emergency spillway to meet the limitations for shape, size, velocity and exit channel. This storm can be handled by any combination of principal spillway discharge, emergency spillway discharge and storage.
- 4) For ponds without a separate emergency spillway, the principal spillway functions as the emergency spillway. In this situation, the principal spillway must comply with the emergency spillway hydrologic criteria.
- 5) All ponds, which are being designed to meet local stormwater requirements, will be required to use the urban criteria. Storm duration used shall be 24 hours except where TR-60 is specified.
- 6) For ponds without a functioning open channel emergency spillway, minimum freeboard will be 2 feet.

**TABLE 2**

Total Height Of Embankment (Feet)	Minimum Top Width (Feet)
10 or less	6
11 - 14	8
15 - 19	10
20 - 24	12
25 - 34	14
35 or more	15

**TABLE 3<sup>1,2</sup>**  
**MINIMUM GAGES**

**CORRUGATED STEEL PIPE**  
2 - 2/3 inches x 1/2 inch Corrugations

Fill Height Over Pipe (Feet)	Pipe Diameter in Inches				
	24 & Less	30	36	42	48
1 - 15	16	16	14	10	10
15 - 20	16	12	10	*	*
20 - 25	16	10	*	*	*

**CORRUGATED STEEL PIPE**  
3 inches x 1 inch or 5 inch x 1 inch Corrugations

Fill Height Over Pipe (Feet)	Pipe Diameter (Inches)						
	Flowable Fill						
	36	42	48	54 <sup>3</sup>	60 <sup>3</sup>	66 <sup>3</sup>	72 <sup>3</sup>
1 - 15	16	16	16	14	14	14	14
15 - 20	16	16	12	14	14	14	14
20 - 25	14	14	10	14	14	14	14

\* Not Permitted.

**TABLE 4<sup>1,2</sup>**  
**MINIMUM GAGES**

**CORRUGATED ALUMINUM PIPE**  
2 - 2/3 inches x 1/2 inch Corrugations

Fill Height Over Pipe (Feet)	Pipe Diameter in Inches		
	21 & Less	24	30
1 - 15	16	14	10
15 - 20	12	10	*
20 - 25	10	*	*

**CORRUGATED ALUMINUM PIPE**  
3 inches x 1 inch Corrugations

Fill Height Over Pipe (Feet)	Pipe Diameter in Inches				
	30	36	42	48	54 <sup>3</sup>
1 - 15	16	16	14	10	14
15 - 20	16	12	*	*	*
20 - 25	12	*	*	*	*

\* Not Permitted.

- <sup>1</sup> Coatings for corrugated metal shall be as specified by the MD-378 Construction Specifications.
- <sup>2</sup> Tables 3 and 4 were developed using the modified Spangler equation. Sizes other than those shown above are not permitted.
- <sup>3</sup> Must use flowable backfill as specified by the MD-378 Construction Specifications and the pipe must be bituminous coated.

**TABLE 5****ACCEPTABLE PLASTIC PIPE FOR USE IN  
EARTH DAM<sup>1,2</sup>**

Nominal Pipe Size (inches)	Schedule or Standard Dimension Ratio (SDR)	Maximum Depth of Fill Over <sup>3</sup>
6 - 24	PVC Schedule 40	10
6 - 24	PVC Schedule 80	15
6 - 24	PVC SDR 26	10
6 - 24	Corrugated HDPE	10

<sup>1</sup> See Specifications, Plastic Pipe

<sup>2</sup> All designs based on Technical Release 77, Reference 20. Other diameters and / or fill heights may be used that meet all the requirements of TR-77.

<sup>3</sup> larger fill heights may be permitted when using flow-able fill.

**TABLE 6****Permissible Velocities (Ft/Sec)  
For Emergency Spillways Lined with Vegetation****Slope Of Exit Channel**

<u>Type of Cover</u>	<u>0 - 5%</u>	<u>5 - 10%</u>
Bermudagrass	6	5
Reed Canarygrass	5	4
Tall Fescue	5	4
Kentucky Bluegrass	5	4
Grass-legume mixture	4	3

## **CONSTRUCTION SPECIFICATIONS**

These specifications are appropriate to all ponds within the scope of the Standard for practice MD-378. All references to ASTM and AASHTO specifications apply to the most recent version.

### **Site Preparation**

Areas designated for borrow areas, embankment, and structural works shall be cleared, grubbed and stripped of topsoil. All trees, vegetation, roots and other objectionable material shall be removed. Channel banks and sharp breaks shall be sloped to no steeper than 1:1. All trees shall be cleared and grubbed within 15 feet of the toe of the embankment.

Areas to be covered by the reservoir will be cleared of all trees, brush, logs, fences, rubbish and other objectionable material unless otherwise designated on the plans. Trees, brush, and stumps shall be cut approximately level with the ground surface. For dry stormwater management ponds, a minimum of a 25-foot radius around the inlet structure shall be cleared.

All cleared and grubbed material shall be disposed of outside and below the limits of the dam and reservoir as directed by the owner or his representative. When specified, a sufficient quantity of topsoil will be stockpiled in a suitable location for use on the embankment and other designated areas.

### **Earth Fill**

**Material** - The fill material shall be taken from approved designated borrow areas. It shall be free of roots, stumps, wood, rubbish, stones greater than 6", frozen or other objectionable materials. Fill material for the center of the embankment, and cut off trench shall conform to Unified Soil Classification GC, SC, CH, or CL and must have at least 30% passing the #200 sieve. Consideration may be given to the use of other materials in the embankment if designed by a geotechnical engineer. Such special designs must have construction supervised by a geotechnical engineer.

Materials used in the outer shell of the embankment must have the capability to support vegetation of the quality required to prevent erosion of the embankment.

**Placement** - Areas on which fill is to be placed shall be scarified prior to placement of fill. Fill materials shall be placed in maximum 8 inch thick (before compaction) layers which are to be continuous over the entire length of the fill. The most permeable borrow material shall be placed in the downstream portions of the embankment. The principal spillway must be installed concurrently with fill placement and not excavated into the embankment.

**Compaction** - The movement of the hauling and spreading equipment over the fill shall be controlled so that the entire surface of each lift shall be traversed by not less than one tread track of heavy equipment or compaction shall be achieved by a minimum of four complete passes of a sheepsfoot, rubber tired or vibratory roller. Fill material shall contain sufficient moisture such that the required degree of compaction will be obtained with the equipment used. The fill material shall contain sufficient moisture so that if formed into a ball it will not crumble, yet not be so wet that water can be squeezed out.

When required by the reviewing agency the minimum required density shall not be less than 95% of maximum dry density with a moisture content within  $\pm 2\%$  of the optimum. Each layer of fill shall be compacted as necessary to obtain that density, and is to be certified by the Engineer at the time of construction. All compaction is to be determined by AASHTO Method T-99 (Standard Proctor).

**Cut Off Trench** - The cutoff trench shall be excavated into impervious material along or parallel to the centerline of the embankment as shown on the plans. The bottom width of the trench shall be governed by the equipment used for excavation, with the minimum width being four feet. The depth shall be at least four feet below existing grade or as shown on the plans. The side slopes of the trench shall be 1 to 1 or flatter. The backfill shall be compacted with construction equipment, rollers, or hand tampers to assure

maximum density and minimum permeability.

**Embankment Core** - The core shall be parallel to the centerline of the embankment as shown on the plans. The top width of the core shall be a minimum of four feet. The height shall extend up to at least the 10 year water elevation or as shown on the plans. The side slopes shall be 1 to 1 or flatter. The core shall be compacted with construction equipment, rollers, or hand tampers to assure maximum density and minimum permeability. In addition, the core shall be placed concurrently with the outer shell of the embankment.

### **Structure Backfill**

Backfill adjacent to pipes or structures shall be of the type and quality conforming to that specified for the adjoining fill material. The fill shall be placed in horizontal layers not to exceed four inches in thickness and compacted by hand tampers or other manually directed compaction equipment. The material needs to fill completely all spaces under and adjacent to the pipe. At no time during the backfilling operation shall driven equipment be allowed to operate closer than four feet, measured horizontally, to any part of a structure. Under no circumstances shall equipment be driven over any part of a concrete structure or pipe, unless there is a compacted fill of 24" or greater over the structure or pipe.

Structure backfill may be flowable fill meeting the requirements of Maryland Department of Transportation, State Highway Administration Standard Specifications for Construction and Materials, Section 313 as modified. The mixture shall have a 100-200 psi; 28 day unconfined compressive strength. The flowable fill shall have a minimum pH of 4.0 and a minimum resistivity of 2,000 ohm-cm. Material shall be placed such that a minimum of 6" (measured perpendicular to the outside of the pipe) of flowable fill shall be under (bedding), over and, on the sides of the pipe. It only needs to extend up to the spring line for rigid conduits. Average slump of the fill shall be 7" to assure flowability of the material. Adequate measures shall be taken (sand

bags, etc.) to prevent floating the pipe. When using flowable fill, all metal pipe shall be bituminous coated. Any adjoining soil fill shall be placed in horizontal layers not to exceed four inches in thickness and compacted by hand tampers or other manually directed compaction equipment. The material shall completely fill all voids adjacent to the flowable fill zone. At no time during the backfilling operation shall driven equipment be allowed to operate closer than four feet, measured horizontally, to any part of a structure. Under no circumstances shall equipment be driven over any part of a structure or pipe unless there is a compacted fill of 24" or greater over the structure or pipe. Backfill material outside the structural backfill (flowable fill) zone shall be of the type and quality conforming to that specified for the core of the embankment or other embankment materials.

### **Pipe Conduits**

All pipes shall be circular in cross section.

**Corrugated Metal Pipe** - All of the following criteria shall apply for corrugated metal pipe:

1. Materials - (Polymer Coated steel pipe) - Steel pipes with polymeric coatings shall have a minimum coating thickness of 0.01 inch (10 mil) on both sides of the pipe. This pipe and its appurtenances shall conform to the requirements of AASHTO Specifications M-245 & M-246 with watertight coupling bands or flanges.

Materials - (Aluminum Coated Steel Pipe) - This pipe and its appurtenances shall conform to the requirements of AASHTO Specification M-274 with watertight coupling bands or flanges. Aluminum Coated Steel Pipe, when used with flowable fill or when soil and/or water conditions warrant the need for increased durability, shall be fully bituminous coated per requirements of AASHTO Specification M-190 Type A. Any aluminum coating damaged or otherwise removed shall be replaced with cold applied bituminous coating compound. Aluminum surfaces that are to be in contact with concrete shall be painted

with one coat of zinc chromate primer or two coats of asphalt.

Materials - (Aluminum Pipe) - This pipe and its appurtenances shall conform to the requirements of AASHTO Specification M-196 or M-211 with watertight coupling bands or flanges. Aluminum Pipe, when used with flowable fill or when soil and/or water conditions warrant for increased durability, shall be fully bituminous coated per requirements of AASHTO Specification M-190 Type A. Aluminum surfaces that are to be in contact with concrete shall be painted with one coat of zinc chromate primer or two coats of asphalt. Hot dip galvanized bolts may be used for connections. The pH of the surrounding soils shall be between 4 and 9.

2. Coupling bands, anti-seep collars, end sections, etc., must be composed of the same material and coatings as the pipe. Metals must be insulated from dissimilar materials with use of rubber or plastic insulating materials at least 24 mils in thickness.
3. Connections - All connections with pipes must be completely watertight. The drain pipe or barrel connection to the riser shall be welded all around when the pipe and riser are metal. Anti-seep collars shall be connected to the pipe in such a manner as to be completely watertight. Dimple bands are not considered to be watertight.

All connections shall use a rubber or neoprene gasket when joining pipe sections. The end of each pipe shall be re-rolled an adequate number of corrugations to accommodate the bandwidth. The following type connections are acceptable for pipes less than 24 inches in diameter: flanges on both ends of the pipe with a circular 3/8 inch closed cell neoprene gasket, pre-punched to the flange bolt circle, sandwiched between adjacent flanges; a 12-inch wide standard lap type band with 12-inch wide by 3/8-inch thick closed cell circular neoprene gasket; and a 12-inch wide hugger type band with o-ring gaskets having a minimum diameter

of 1/2 inch greater than the corrugation depth. Pipes 24 inches in diameter and larger shall be connected by a 24 inch long annular corrugated band using a minimum of 4 (four) rods and lugs, 2 on each connecting pipe end. A 24-inch wide by 3/8-inch thick closed cell circular neoprene gasket will be installed with 12 inches on the end of each pipe. Flanged joints with 3/8 inch closed cell gaskets the full width of the flange is also acceptable.

Helically corrugated pipe shall have either continuously welded seams or have lock seams with internal caulking or a neoprene bead.

4. Bedding - The pipe shall be firmly and uniformly bedded throughout its entire length. Where rock or soft, spongy or other unstable soil is encountered, all such material shall be removed and replaced with suitable earth compacted to provide adequate support.
5. Backfilling shall conform to "**Structure Backfill**".
6. Other details (anti-seep collars, valves, etc.) shall be as shown on the drawings.

**Reinforced Concrete Pipe** - All of the following criteria shall apply for reinforced concrete pipe:

1. Materials - Reinforced concrete pipe shall have bell and spigot joints with rubber gaskets and shall equal or exceed ASTM C-361.
2. Bedding - Reinforced concrete pipe conduits shall be laid in a concrete bedding / cradle for their entire length. This bedding / cradle shall consist of high slump concrete placed under the pipe and up the sides of the pipe at least 50% of its outside diameter with a minimum thickness of 6 inches. Where a concrete cradle is not needed for structural reasons, flowable fill may be used as described in the "**Structure Backfill**" section of this standard. Gravel bedding is not permitted.

3. Laying pipe - Bell and spigot pipe shall be placed with the bell end upstream. Joints shall be made in accordance with recommendations of the manufacturer of the material. After the joints are sealed for the entire line, the bedding shall be placed so that all spaces under the pipe are filled. Care shall be exercised to prevent any deviation from the original line and grade of the pipe. The first joint must be located within 4 feet from the riser.
4. Backfilling shall conform to "**Structure Backfill**".
5. Other details (anti-seep collars, valves, etc.) shall be as shown on the drawings.

**Plastic Pipe** - The following criteria shall apply for plastic pipe:

1. Materials - PVC pipe shall be PVC-1120 or PVC-1220 conforming to ASTM D-1785 or ASTM D-2241. Corrugated High Density Polyethylene (HDPE) pipe, couplings and fittings shall conform to the following: 4" – 10" inch pipe shall meet the requirements of AASHTO M252 Type S, and 12" through 24" inch shall meet the requirements of AASHTO M294 Type S.
2. Joints and connections to anti-seep collars shall be completely watertight.
3. Bedding -The pipe shall be firmly and uniformly bedded throughout its entire length. Where rock or soft, spongy or other unstable soil is encountered, all such material shall be removed and replaced with suitable earth compacted to provide adequate support.
4. Backfilling shall conform to "**Structure Backfill**".
5. Other details (anti-seep collars, valves, etc.) shall be as shown on the drawings.

**Drainage Diaphragms** - When a drainage diaphragm is used, a registered professional engineer will supervise the design and construction inspection.

### **Concrete**

Concrete shall meet the requirements of Maryland Department of Transportation, State Highway Administration Standard Specifications for Construction and Materials, Section 414, Mix No. 3.

### **Rock Riprap**

Rock riprap shall meet the requirements of Maryland Department of Transportation, State Highway Administration Standard Specifications for Construction and Materials, Section 311.

Geotextile shall be placed under all riprap and shall meet the requirements of Maryland Department of Transportation, State Highway Administration Standard Specifications for Construction and Materials, Section 921.09, Class C.

### **Care of Water during Construction**

All work on permanent structures shall be carried out in areas free from water. The Contractor shall construct and maintain all temporary dikes, levees, cofferdams, drainage channels, and stream diversions necessary to protect the areas to be occupied by the permanent works. The contractor shall also furnish, install, operate, and maintain all necessary pumping and other equipment required for removal of water from various parts of the work and for maintaining the excavations, foundation, and other parts of the work free from water as required or directed by the engineer for constructing each part of the work. After having served their purpose, all temporary protective works shall be removed or leveled and graded to the extent required to prevent obstruction in any degree whatsoever of the flow of water to the spillway or outlet works and so as not to interfere in any way with the operation or maintenance of the structure. Stream diversions shall be maintained until the full flow can be passed through the permanent works. The removal of water from the required excavation and the foundation shall be accomplished in a manner and to the extent that will maintain stability of the excavated slopes and bottom required excavations and will allow satisfactory per-

formance of all construction operations. During the placing and compacting of material in required excavations, the water level at the locations being refilled shall be maintained below the bottom of the excavation at such locations which may require draining the water sumps from which the water shall be pumped.

### **Stabilization**

All borrow areas shall be graded to provide proper drainage and left in a sightly condition. All exposed surfaces of the embankment, spillway, spoil and borrow areas, and berms shall be stabilized by seeding, liming, fertilizing and mulching in accordance with the Natural Resources Conservation Service Standards and Specifications for Critical Area Planting (MD-342) or as shown on the accompanying drawings.

### **Erosion and Sediment Control**

Construction operations will be carried out in such a manner that erosion will be controlled and water and air pollution minimized. State and local laws concerning pollution abatement will be followed. Construction plans shall detail erosion and sediment control measures.



## **OPERATION AND MAINTENANCE**

An operation and maintenance plan in accordance with Local or State Regulations will be prepared for all ponds. As a minimum, the dam inspection checklist located in Appendix A shall be included as part of the operation and maintenance plan and performed at least annually. Written records of maintenance and major repairs needs to be retained in a file. The issuance of a Maintenance and Repair Permit for any repairs or maintenance that involves the modification of the dam or spillway from its original design and specifications is required. A permit is also required for any repairs or reconstruction that involve a substantial portion of the structure. All indicated repairs are to be made as soon as practical.

## **SUPPORTING DATA AND DOCUMENTATION**

### **Field Data and Survey Notes**

The following is a list of the minimum data needed:

1. Profile along centerline of structure.
2. Profile along centerline of principal spillway.
3. Profile along centerline of emergency spillway.
4. Survey of storage area to develop topography and storage volumes.
5. Soil investigation logs and notes.

### **Design Data**

Record on appropriate engineering paper. The following is a list of the minimum required design data:

1. Determine pond class and list appropriate spillway design criteria, including map.
2. Determine peak runoff from the contributing area for the design storms selected, including topo map.
3. Develop a stage-storage/discharge curve for the site.
4. Determine the pipe spillway by storm routing using the procedure in the SWM Pond Design Manual; Chapter 11, EFH; Chapter 6, TR-55; or TR-20.
5. Design emergency spillway using EFH 11-61.
6. Drawings should show the following as a minimum: profile along centerline of dam; profile along centerline of emergency spillway; cross section through dam at principal spillway; cross section through emergency spillway; plan view; and construction details & notes and soil logs.

7. Compute earth fill (if needed).
8. Special design feature details; watering, fire hydrants, fish management, irrigation, outfall stabilization, etc.; structural details with design loadings, if applicable, should be shown on the drawings.
9. Complete data required on MD-ENG-14.
10. Record seeding plan on drawings or MD-CONS-10.
11. A written Operation and Maintenance Plan.

### **Construction Check Data/As-built**

Record on survey note paper, SCS-ENG-28. Survey data for ponds will be plotted in red. All construction inspection visits shall be recorded on the CPA-6 or appropriate documentation paper. The documentation shall include the date, who performed the inspection, specifics as to what was inspected, all alternatives discussed, and decisions made and by whom. The following is a list of the minimum data needed for As-Built:

1. A profile of the top of the dam.
2. A cross-section of the emergency spillway at the control section.
3. A profile along the centerline of the emergency spillway.
4. A profile along the centerline of the principal spillway extending at least 100 feet downstream of the fill.
5. The elevation of the principal spillway crest.
6. The elevation of the principal spillway conduit invert (inlet and outlet).
7. The diameter, length, thickness and type of material for the riser.
8. The diameter, length, and type of material for the conduit.

9. The size and type of anti-vortex and trash rack device and its elevations in relation to the principal spillway crest.
10. The number, size and location of the anti-seep collars.
11. The diameter and size of any low stage orifices or drain pipes.
12. Show the length, width, and depth of contours of the pool area so that design volume can be verified.
13. Notes and measurements to show that any special design features were met.
14. Statement on seeding and fencing.
15. Notes on site clean up and disposal.
16. Sign and date check notes to include statement that practice meets or exceeds plans and specifications.

**REFERENCES**

1. *AWWA Standards*, American Water Works Association, Denver, Colorado.
2. *ASTM Standards*, American Society for Testing and Materials, Philadelphia, Pennsylvania.
3. *Engineering Field Handbook, Part 650*, USDA, Soil Conservation Service.
4. *Handbook of PVC Pipe Design and Construction*, First Edition, Uni-Bell Plastic Pipe Association, Dallas, Texas, 1980.
5. *Handbook of Steel Drainage and Highway Construction Products*, Third Edition, American Iron and Steel Institute, Washington, D.C., 1983.
6. *Maryland Dam Safety Manual*, Maryland Department of Natural Resources, Water Resources Administration, Annapolis, Maryland, June 1993.
7. *Maryland Technical Guide, Section IV, Standards and Specifications*, USDA, Natural Resources Conservation Service.
8. *National Engineering Handbook, Section 4, Hydrology*, USDA, Natural Resources Conservation Service, March 1985.
9. *National Engineering Handbook, Section 5, Hydraulics*, USDA, Natural Resources Conservation Service, August 1956.
10. *National Engineering Handbook, Section 11, Drop Spillways*, USDA, Natural Resources Conservation Service, April 1968.
11. *National Engineering Handbook, Section 14, Chute Spillways*, USDA, Natural Resources Conservation Service, October 1977.
12. *National Handbook of Conservation Practices*, USDA, Natural Resources Conservation Service.
13. *Standard Specifications for Materials and Methods of Sampling and Testing*, Nineteenth Edition, American Association of State Highway and Transportation Officials, Washington D.C., 1998.
14. *Standard Specifications for Construction and Materials*, Maryland Department of Transportation, State Highway Administration, Baltimore, Maryland, October 1993.
15. Technical Release No. 20, *Computer Programs for Project Formulation Hydrology*, USDA, Natural Resources Conservation Service, 1992.
16. Technical Release No. 55, *Urban Hydrology for Small Watersheds*, USDA, Natural Resources Conservation Service, 1986.
17. Technical Release No. 56, *A Guide for Design and Layout of Vegetative Wave Protection for Earth Dam Embankments*, USDA, Natural Resources Conservation Service, 1974.
18. Technical Release No. 60, *Earth Dams and Reservoirs*, USDA, Natural Resources Conservation Service, 1985.
19. Technical Release 69, *Riprap for Slope Protection Against Wave Action*, USDA, Natural Resources Conservation Service, 1983.

20. Technical Release No. 77, *Design and Installation of Flexible Conduits*, USDA, Natural Resources Conservation Service, 1990.
21. *National Engineering Handbook, Part 633, Chapter 26, Gradation Design of Sand and Gravel Filters*, USDA, Natural Resources Conservation Service, October 1994.

APPENDIX A

**DAM INSPECTION CHECKLIST**

To help the dam owner perform periodic safety inspections of the structure, a checklist is provided. Each item of the checklist should be completed. **Repair** is required when obvious problems are observed. **Monitoring** is recommended if there is potential for a problem to occur in the future. **Investigation** is necessary if the reason for the observed problem is not obvious.

A brief description should be made of any noted irregularities, needed maintenance, or problems. Abbreviations and short descriptions are recommended. Space at the bottom of the form should be used for any items not listed.

DAM _____ OWNER _____ INSPECTED BY _____		DATE _____ WEATHER _____ POOL LEVEL _____		Y / N	MON I T O R	RE P A I R	I N V E S T I G A T E
Item	Comments						
1. CREST							
a. Visual settlement?							
b. Misalignment?							
c. Cracking?							
2. UPSTREAM SLOPE							
a. Erosion?							
b. Ground cover in good condition?							
c. Trees, shrubs, or other woody vegetation?							
d. Longitudinal/Vertical cracks?							
e. Adequate riprap protection?							
f. Stone deterioration?							
g. Settlements, depressions, or bulges?							
3. DOWNSTREAM SLOPE							
a. Erosion?							
b. Ground cover in good condition?							
c. Trees, shrubs, or other woody vegetation?							
d. Longitudinal/Vertical cracks?							
e. Riprap protection adequate?							
f. Settlements, depressions, or bulges?							
g. Soft spots or boggy areas?							
h. Movement at or beyond toe?							
i. Boils at toe?							
4. DRAINAGE-SEEPAGE CONTROL							
a. Internal drains flowing?	Est. Left _____ gpm	Est. Right _____ gpm					
b. Seepage at toe?	Estimated _____ gpm						
c. Does seepage contain fines?							

INSPECTION CHECKLIST - PAGE 2		Y / N	M O N I T O R	R E P A I R	I N V E S T I G A T E
INSPECTED BY _____	DATE _____				
Item	Comments				
<b>5. ABUTMENT CONTACTS</b>					
a. Erosion?					
b. Differential movement?					
c. Cracks?					
d. Seepage?	Estimated _____ gpm				
e. Adequate erosion protection for ditches?					
<b>6. INLET STRUCTURE</b>		Concrete or Metal Pipe (circle one)			
a. Seepage into structure?					
b. Debris or obstructions?					
c. If concrete, do surfaces show:					
1. Spalling?					
2. Cracking?					
3. Erosion?					
4. Scaling?					
5. Exposed reinforcement?					
6. Other?					
d. If metal, do surfaces show:					
1. Corrosion?					
2. Protective Coating deficient?					
3. Misalignment or split seams?					
e. Do the joints show:					
1. Displacement or offset?					
2. Loss of joint material?					
3. Leakage?					
f. Are the trash racks:					
1. Broken or bent?					
2. Corroded or rusted?					
3. Obstructed?					
4. Operational?					
g. Sluice/Drain gates:					
1. Broken or bent?					
2. Corroded or rusted?					
3. Leaking?					
4. Not seated correctly?					
4. Periodically maintained?					
5. Operational?					

INSPECTION CHECKLIST - PAGE 3		Y / N	M O N I T O R	R E P A I R	I N V E S T I G A T E
INSPECTED BY _____	DATE _____				
Item	Comments				
<b>7. PRINCIPAL SPILLWAY PIPE</b>		Concrete or Metal Pipe (circle one)			
a. Seepage into conduit?					
b. Debris present?					
c. Do concrete surfaces show:					
1. Spalling?					
2. Cracking?					
3. Erosion?					
4. Scaling?					
5. Exposed reinforcement?					
6. Other?					
d. Do the joints show:					
1. Displacement or offset?					
2. Loss of joint material?					
3. Leakage?					
<b>8. STILLING BASIN/POOL</b>		Riprap or Concrete (circle one)			
a. If concrete, condition of surfaces?					
b. Deterioration or displacement of joints?					
c. Outlet channel obstructed?					
d. Is released water:					
1. Undercutting the outlet?					
2. Eroding the embankment?					
3. Displacing riprap?					
4. Scouring the plunge pool?					
e. Tailwater elevation and flow condition:					
<b>9. EMERGENCY SPILLWAY</b>					
a. Is the channel:					
1. Eroding or backcutting?					
2. Obstructed?					
b. Trees or shrubs in the channel?					
c. Seepage present?					
d. Soft spots or boggy areas?					
e. Channel slopes eroding or sloughing?					
<b>10. RESERVOIR</b>					
a. High water marks?					
b. Erosion/Slides into pool area?					
c. Sediment accumulation?					
d. Floating debris present?					
e. Adequate riprap protection for ditches?					



APPENDIX B

ROADWAY EMBANKMENT  
DESIGN CRITERIA

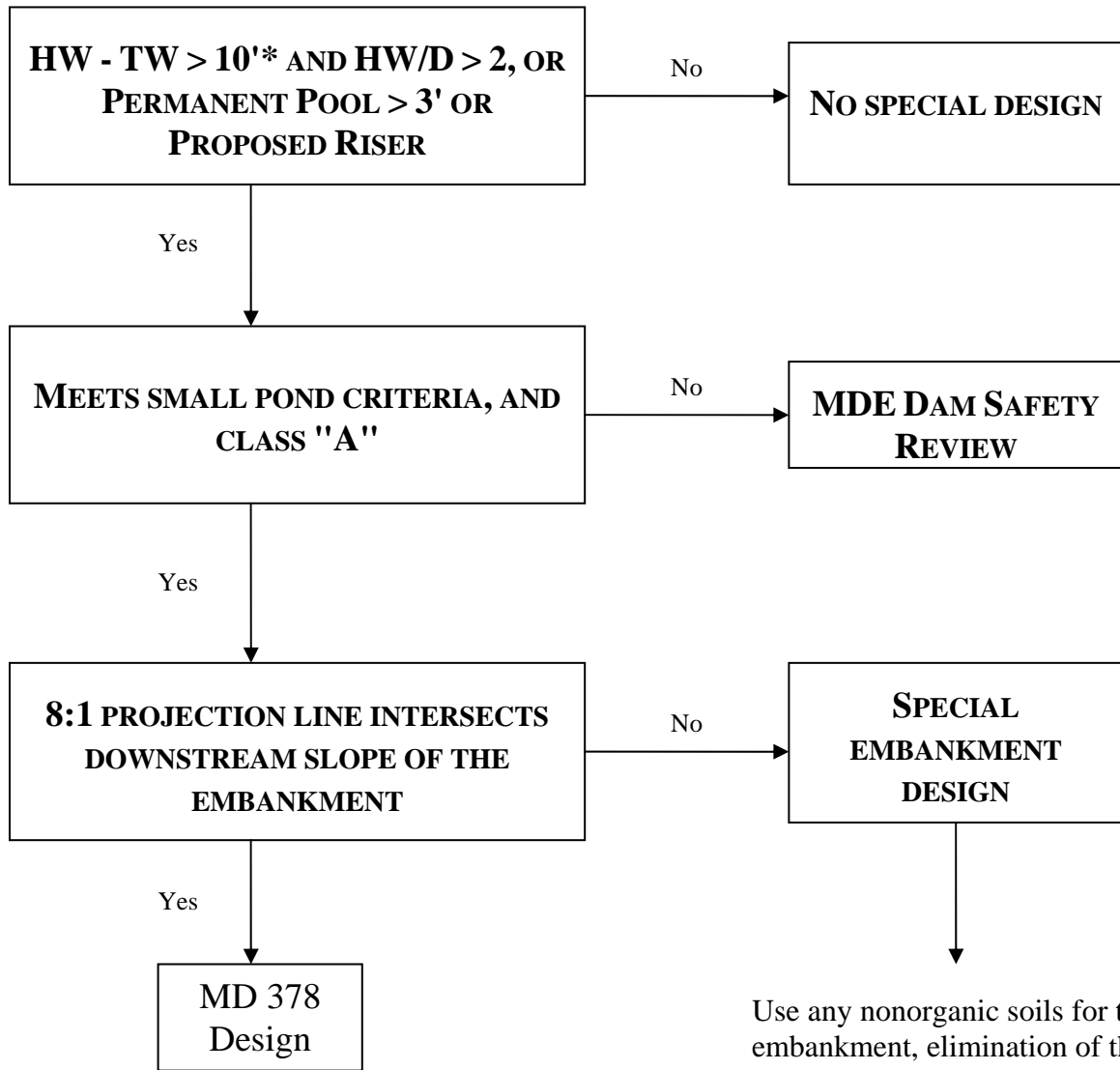

Use any nonorganic soils for the embankment, elimination of the cut-off trench and core based on approval of geotechnical engineer and acceptable to local jurisdictions.

Filter diaphragm is required.

All other MD 378 criteria apply.

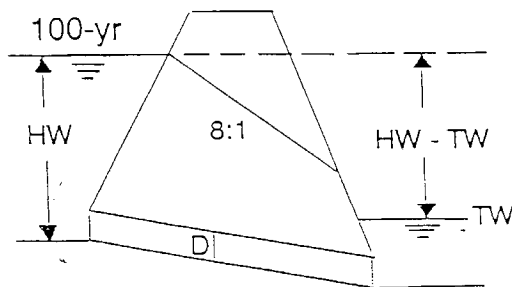

\* Use HW when TW is below the inlet invert elevation.

Appendix

**B.1.1**

**Supplemental Pond and Wetland Specifications (Non-378)**

---

**Supplemental Stormwater Pond and Wetland Specifications (Non-378)**

These notes and specifications are in addition to the MD-378 Specifications. If there is any question as to their applicability, the MD-378 Specifications supercede.

1. It is preferred to use the same material in the embankment as is being installed for the core trench. If this is not possible because the appropriate material is not available, a dam core with a shell may be used. The cross-section of the stormwater facility should show the limits of the dam core (up to the 10-year water surface elevation) as well as the acceptable materials for the shell. The shape of the dam core and the material to be used in the shell should be provided by the geotechnical engineer.
2. If the compaction tests for site improvements is using a Modified Proctor (AASHTO T-180), then to maintain on-site consistency, the Modified Proctor may be used in lieu of a Standard Proctor (AASHTO T-99). The minimum required density using the Modified Proctor test method shall be at least 92% of maximum dry density with a moisture content of  $\pm 2\%$  of the optimum. The minimum required density using the Standard Proctor test method shall be at least 95% of the maximum dry density with a moisture content of  $\pm 2\%$  of the optimum.
3. For all stormwater management facilities, a geotechnical engineer or their representative must be present to verify compaction in accordance with the selected test method. This information needs to be provided in a report to the design engineer, so that certification of the construction of the facility, in accordance with MD-378 specifications, can be made.
4. A 4-inch layer of topsoil shall be placed on all disturbed areas of the dam embankment. Seeding, liming, fertilizing, mulching, etc. shall be in accordance with Maryland Soil Conservation Service MD-342 or the 1994 Maryland Standards and Specifications for Soil Erosion and Sediment Control "Permanent Seeding," Section in Chapter 20. The purpose of the topsoil is to establish a good growth of grass which is not always possible with some of the materials that may be placed for the embankment fill.
5. Geotextile placed beneath rip-rap shall be Class "C" geotextile or better (see Section 24.0, Material Specifications, 1994 Standards and Specifications for Soil Erosion and Sediment Control (MDE, 1994). Some acceptable geotextiles that meet the Class "C" criteria include:

Amoco 4552  
GEOLON N70  
WEBTEC N07

Carthage FX-70S  
Mirafi 180-N

## Appendix B.1.1 Supplemental Specifications (Non-378)

---

This is only a partial listing of available geotextiles based on information provided by the manufacturers to the 1997 Specifier's Guide dated December 1996. It is the responsibility of the engineer to verify the adequacy of the material, as there are changes in the manufacturing process and the type of fabric used, which may affect the continued acceptance.

6. A rule of thumb to determine when an excavated pond may need to be considered an embankment pond is as follows:
  - Provide calculation of  $10H + 20 \text{ feet} = L$ , where H equals height from pond bottom to top of dam. If the projection of L, downstream in a horizontal line from the upstream toe of slope is below existing ground, the pond can be considered an excavated pond. In addition, the existing ground slope, downstream of the toe, must be less than 10%.
7. The design engineer and geotechnical engineer should make the determination that the settlement of the pond will not cause excessive joint extension. For further information on joint extension analysis, see NRCS Publication TR-18.
8. Fill placement **shall not** exceed a maximum 8-inch. Each lift shall be continuous for the entire length of the embankment.
9. The embankment fill **shall not** be placed higher than the centerline of the principal spillway until after the principal spillway has been installed. If the embankment needs to be excavated to install the principal spillway, the side slope shall be no less than 2:1.
10. The side slopes of a cut to repair a dam, install a principal spillway for an excavated pond, or other repair work, shall be no less than 2:1.

Appendix  
**B.1.2**

**MDE Dam Safety Division Small Pond Review Criteria**

## Appendix B.1.2. Small Pond Approval Criteria

---

The following criteria are established for the MDE Dam Safety Division small pond review and approval:

- 1) If any of the following apply, a permit is required from the MDE Dam Safety Division:
  - a) Drainage area of the pond is greater than 640 acres.
  - b) Dam embankment height is greater than 20 feet (top of dam to lowest point on the upstream toe).
  - c) Pond is an intermediate or high hazard structure the failure of which is likely to cause damage to homes, public transportation, loss of life or property (NRCS Class b & c).
- 2) If the pond is in a USE III watershed, a permit is required if the pond will be:
  - a) Capturing a flowing stream (stream with a base flow\*),
  - b) Capturing any spring, or
  - c) A wet pond, or
  - d) Located within 100 feet of a flowing stream, or
  - e) Proposes extended detention for the one year storm longer than 12 hours.
- 3) If the pond is located within the drainage of the Gwynns Falls, Jones Falls, or Herring Run streams situated in or adjacent to Baltimore City, approval is required in accordance with the provisions of the Maryland Environment Article 5-503.
- 4) If the pond is to be constructed across a stream, excluding USE III waters, **SCD** may approve the pond with verification that the 100 year pool based on ultimate development with current zoning does not increase flooding on adjacent properties or is in a floodplain easement. The in-stream closure period must be noted on the plans.
- 5) If the pond is in the floodplain, an MDE Nontidal Wetlands and Waterways Permit may be required. The pond will be evaluated for potential impacts in the floodplain and to nontidal wetlands. However, the pond construction plans may be approved by the **SCD**.

\* “Base Flow” or “Dry Weather Flow” - Stream flows originating from groundwater or spring contributions that are not influenced by storm events. Base flow measurements should not be made within two days of a storm event.

## Appendix B.1.2. Small Pond Approval Criteria

Figure B.1.2.1 Small Pond Review Flow Chart

This flow chart is intended to determine whether MDE or the local SCD will review construction plans. SCD pond approval does not relieve the applicant from obtaining other necessary approvals associated with pond construction such as impacts to nontidal wetlands.

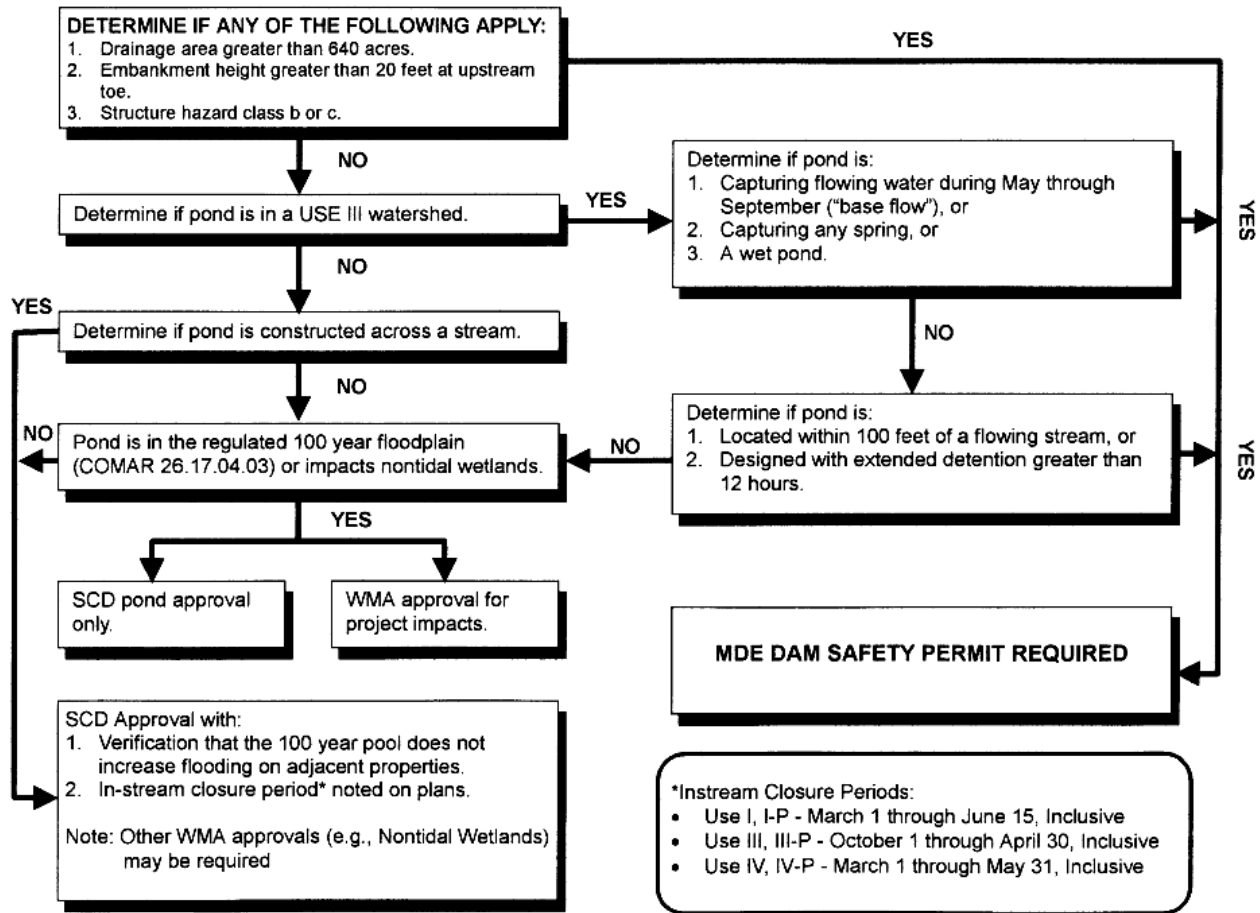

**Appendix**

**B.2**

**Construction Specifications for Infiltration Practices**



### **B.2.A Infiltration Trench General Notes and Specifications**

An infiltration trench may not receive run-off until the entire contributing drainage area to the infiltration trench has received final stabilization.

1. Heavy equipment and traffic shall be restricted from traveling over the proposed location of the infiltration trench to minimize compaction of the soil.
2. Excavate the infiltration trench to the design dimensions. Excavated materials shall be placed away from the trench sides to enhance trench wall stability. Large tree roots must be trimmed flush with the trench sides in order to prevent fabric puncturing or tearing of the filter fabric during subsequent installation procedures. The side walls of the trench shall be roughened where sheared and sealed by heavy equipment.
3. A Class “C” geotextile or better (see Section 24.0, Material Specifications, 1994 Standards and Specifications for Soil Erosion and Sediment Control, MDE, 1994) shall interface between the trench side walls and between the stone reservoir and gravel filter layers. A partial list of non-woven filter fabrics that meet the Class “C” criteria follows. Any alternative filter fabric must be approved by the plan approval authority.

Amoco 4552  
GEOLON N70  
WEBTEC N07

Carthage FX-80S  
Mirafi 180-N

The width of the geotextile must include sufficient material to conform to trench perimeter irregularities and for a 6-inch minimum top overlap. The filter fabric shall be tucked under the sand layer on the bottom of the infiltration trench for a distance of 6 to 12 inches. Stones or other anchoring objects should be placed on the fabric at the edge of the trench to keep the trench open during windy periods. When overlaps are required between rolls, the uphill roll should lap a minimum of 2 feet over the downhill roll in order to provide a shingled effect.

4. If a 6 inch sand filter layer is placed on the bottom of the infiltration trench, the sand for the infiltration trench shall be washed and meet AASHTO-M-43, Size No. 9 or No. 10. Any alternative sand gradation must be approved by the plan approval authority.
5. The stone aggregate should be placed in a maximum loose lift thickness of 12 inches. The gravel (rounded “bank run” gravel is preferred) for the infiltration trench shall be washed and meet one of the following AASHTO-M-43, Size No. 2 or No. 3.
6. Following the stone aggregate placement, the filter fabric shall be folded over the stone aggregate to form a 6-inch minimum longitudinal lap. The desired fill soil or stone aggregate shall be placed over the lap at sufficient intervals to maintain the lap during subsequent backfilling.

## Appendix B.2. Construction Specifications for Infiltration Practices

---

7. Care shall be exercised to prevent natural or fill soils from intermixing with the stone aggregate. All contaminated stone aggregate shall be removed and replaced with uncontaminated stone aggregate.
8. Voids may occur between the fabric and the excavation sides shall be avoided. Removing boulders or other obstacles from the trench walls is one source of such voids. Therefore, natural soils should be placed in these voids at the most convenient time during construction to ensure fabric conformity to the excavation sides.
9. Vertically excavated walls may be difficult to maintain in areas where soil moisture is high or where soft cohesive or cohesionless soils are dominant. These conditions may require laying back of the side slopes to maintain stability.
10. PVC distribution pipes shall be Schedule 40 and meet ASTM-D-1785. All fittings shall meet ASTM-D-2729. Perforations shall be 3/8 inch in diameter. A perforated pipe shall be provided only within the infiltration trench and shall terminate 1 foot short of the infiltration trench wall. The end of the PVC pipe shall be capped. **Note:** PVC pipe with a wall thickness classification of SDR-35 meeting ASTM-D-3034 is an acceptable substitute for the Schedule 40 pipe.
11. The observation well is to consist of 6-inch diameter perforated PVC Schedule 40 pipe (M 278 OR F758, Type PS 28) with a cap set 6 inches above ground level and is to be located near the longitudinal center of the infiltration trench. The pipe shall have a plastic collar with ribs to prevent rotation when removing the cap. The screw top lid shall be a cleanout with a locking mechanism or special bolt to discourage vandalism. The depth to the invert shall be marked on the lid. The pipe shall be placed vertically within the gravel portion of the infiltration trench and a cap provided at the bottom of the pipe. The bottom of the cap shall rest on the infiltration trench bottom.
12. Corrugated metal distribution pipes shall conform to AASHTO-M-36, and shall be aluminized in accordance with AASHTO-M-274. Aluminized pipe in contact with concrete shall be coated with an inert compound capable of preventing the deleterious effect of the aluminum on the concrete. Perforated distribution pipes shall conform to AASHTO-M-36, Class 2 and shall be provided only within the infiltration trench and shall terminate 1 foot short of the infiltration trench wall. An aluminized metal plate shall be welded to the end of the pipe.
13. If a distribution structure with a wet well is used, a 4-inch drain pipe shall be provided at opposite ends of the infiltration trench distribution structure. Two (2) cubic feet of porous backfill meeting AASHTO-M-43, Size No. 57 shall be provided at each drain.

14. If a distribution structure is used, the manhole cover shall be bolted to the frame.

### **B.2.B Infiltration Basins Notes and Specifications**

An infiltration basin may not receive run-off until the entire contributing drainage area to the basin has received final stabilization.

1. The sequence of various phases of basin construction shall be coordinated with the overall project construction schedule. A program should schedule rough excavation of the basin with the rough grading phase of the project to permit use of the material as fill in earthwork areas. The partially excavated basin, however, **cannot** serve as a sedimentation basin.

Specifications for basin construction should state: (1) the earliest point in progress when storm drainage may be directed to the basin, and (2) the means by which this delay in use is to be accomplished. Due to the wide variety of conditions encountered among projects, each should be separately evaluated in order to postpone use as long as is reasonably possible.

2. Initial basin excavation should be carried to within 2 feet of the final elevation of the basin floor. Final excavation to the finished grade should be deferred until all disturbed areas on the watershed have been stabilized or protected. The final phase excavation should remove all accumulated sediment. Relatively light tracked equipment is recommended for this operation to avoid compaction of the basin floor. After the final grading is completed, the basin should provide a well-aerated, highly porous surface texture.
3. Infiltration basins may be lined with a 6- to 12-inch layer of filter material such as coarse sand (AASHTO-M-43, Sizes 9 or 10) to help prevent the buildup of impervious deposits on the soil surface. The filter layer can be replaced or cleaned when it becomes clogged. When a 6-inch layer of coarse organic material is specified for discing (such as hulls, leaves, stems, etc.) or spading into the basin floor to increase the permeability of the soils, the basin floor should be soaked or inundated for a brief period, then allowed to dry subsequent to this operation. This induces the organic material to decay rapidly, loosening the upper soil layer.
4. Establishing dense vegetation on the basin side slopes and floor is recommended. A dense vegetative stand will not only prevent erosion and sloughing, but will also provide a natural means of maintaining relatively high infiltration rates. Erosion protection of inflow points to the basin shall also be provided.
5. Selection of suitable vegetative materials for the side slope and all other areas to be stabilized with vegetation and application of soil amendments (e.g., lime, fertilizer, etc.) shall be done in accordance with the NRCS Standards and Specifications for Critical Area

## Appendix B.2. Construction Specifications for Infiltration Practices

---

Planting (MD-342) or the 1994 Maryland Standards and Specifications for Soil Erosion and Sediment Control.

6. Grasses of the fescue family are recommended for seeding primarily due to their adaptability to dry sandy soils, drought resistance, hardiness, and ability to withstand brief inundations. The use of fescues will also permit long intervals between mowings. This is important due to the relatively steep slopes which make mowing difficult. Mowing twice a year, once in June and again in September, is generally satisfactory. Refertilization with 10-6-4 ratio fertilizer at a rate of 500 lb per acre (11 lb per 1000 sq ft) may be required the second year after seeding.

**Appendix**

**B.3**

**Construction Specifications for  
Sand Filters, Bioretention and Open Channels**

### **B.3.A Sand Filter Specifications**

#### **1. Material Specifications for Sand Filters**

The allowable materials for sand filter construction are detailed in Table B.3.1.

#### **2. Sand Filter Testing Specifications**

Underground sand filters, facilities within sensitive groundwater aquifers, and filters designed to serve urban hot spots are to be tested for water tightness prior to placement of filter media. Entrances and exits should be plugged and the system completely filled with water to demonstrate water tightness. Water tightness means no leakage for a period of 8 hours.

All overflow weirs, multiple orifices and flow distribution slots are to be field-tested to verify adequate distribution of flows.

#### **3. Sand Filter Construction Specifications**

Provide sufficient maintenance access (i.e., 12-foot-wide road with legally recorded easement). Vegetated access slopes are to be a maximum of 10%; gravel slopes to 15%; paved slopes to 25%.

Absolutely no runoff is to enter the filter until all contributing drainage areas have been stabilized.

Surface of filter bed is to be level.

All underground sand filters should be clearly delineated with signs so that they may be located when maintenance is due.

Surface sand filters may be planted with appropriate grasses; see Appendix A.

“Pocket” sand filters (and residential bioretention facilities treating areas larger than an acre) shall be sized with a stone “window” that covers approximately 10% of the filter area. This “window” shall be filled pea gravel (3/4 inch stone).

#### **4. Specifications Pertaining to Underground Sand Filters (F-2)**

Provide manhole and/or grates to all underground and below grade structures. Manholes shall be in compliance with standard specifications for each county but diameters should be 30" minimum (to comply with OSHA confined space requirements). Aluminum and steel louvered doors are also acceptable. Ten inch wide (minimum) manhole steps (12" o.c.) shall be cast in place or drilled and mortared into the wall below each manhole. A 5' minimum height clearance (from the top of the sand layer to the bottom of the upper/surface slab) is required for all permanent underground structures. Lift rings are to be supplied to remove/replace top slabs on pre-fabricated structures. Manhole covers should allow for proper ventilation.

Underground sand filters should be constructed with a gate valve located just above the top of the filter bed for dewatering in the event that clogging occurs.

Underground sand beds shall be protected from trash accumulation by a wide mesh geotextile screen to be placed on the surface of the sand bed; screen is to be rolled up, removed, cleaned and re-installed during maintenance operations.

Table B.3.1 Material Specifications for Sand Filters

Material	Specification/Test Method	Size	Notes
sand	clean AASHTO-M-6 or ASTM-C-33 concrete sand	0.02" to 0.04"	Sand substitutions such as Diabase and Graystone #10 are not acceptable. No calcium carbonated or dolomitic sand substitutions are acceptable. No "rock dust" can be used for sand.
peat	ash content: < 15% pH range: 5.2 to 4.9 loose bulk density 0.12 to 0.15 g/cc	n/a	The material must be reed-sedge hemic peat, shredded, uncompacted, uniform, and clean.
leaf compost		n/a	
underdrain gravel	AASHTO-M-43	0.375" to 0.75"	
geotextile fabric (if required)	ASTM-D-4833 (puncture strength - 125 lb.) ASTM-D-4632 (Tensile Strength - 300 lb.)	<b>0.08"</b> thick equivalent opening size of #80 sieve	Must maintain 125 gpm per sq. ft. flow rate. Note: a 4" pea gravel layer may be substituted for geotextiles meant to "separate" sand filter layers.
impermeable liner (if required)	ASTM-D-4833 (thickness) ASTM-D-412 (tensile strength 1,100 lb., elongation 200%) ASTM-D-624 (Tear resistance - 150 lb./in) ASTM-D-471 (water adsorption: +8 to -2% mass)	30 mil thickness	Liner to be ultraviolet resistant. A geotextile fabric should be used to protect the liner from puncture.
underdrain piping	F 758, Type PS 28 or AASHTO-M-278	4" - 6" rigid schedule 40 PVC or SDR35	3/8" perf. @ 6" on center, 4 holes per row; minimum of 3" of gravel over pipes; not necessary underneath pipes
concrete (cast-in-place)	MSHA Standards and Specs. Section 902, Mix No. 3, $f'_c = 3500$ psi, normal weight, air-entrained; re-inforcing to meet ASTM-615-60	n/a	on-site testing of poured-in-place concrete required: 28 day strength and slump test; all concrete design (cast-in-place or pre-cast) <i>not using previously approved State or local standards</i> requires design drawings sealed and approved by a professional structural engineer licensed in the State of Maryland
concrete (pre-cast)	per pre-cast manufacturer	n/a	SEE ABOVE NOTE
non-rebar steel	ASTM A-36	n/a	structural steel to be hot-dipped galvanized ASTM-A-123



### **B.3.B Specifications for Bioretention**

#### **1. Material Specifications**

The allowable materials to be used in bioretention area are detailed in Table B.3.2.

#### **2. Planting Soil**

The soil shall be a uniform mix, free of stones, stumps, roots or other similar objects larger than two inches. No other materials or substances shall be mixed or dumped within the bioretention area that may be harmful to plant growth, or prove a hindrance to the planting or maintenance operations. The planting soil shall be free of Bermuda grass, Quackgrass, Johnson grass, or other noxious weeds as specified under COMAR 15.08.01.05.

The planting soil shall be tested and shall meet the following criteria:

pH range	5.2 - 7.0
organic matter	1.5 - 4% (by weight)
magnesium	35 lb./ac
phosphorus (phosphate - P <sub>2</sub> O <sub>5</sub> )	75 lb./ac
potassium (potash - K <sub>2</sub> O)	85 lb./ac
soluble salts	not to exceed 500 ppm

All bioretention areas shall have a minimum of one test. Each test shall consist of both the standard soil test for pH, phosphorus, and potassium and additional tests of organic matter, and soluble salts. A textural analysis is required from the site stockpiled topsoil. If topsoil is imported, then a texture analysis shall be performed for each location where the top soil was excavated.

Since different labs calibrate their testing equipment differently, all testing results shall come from the same testing facility.

Should the pH fall out of the acceptable range, it may be modified (higher) with lime or (lower) with iron sulfate plus sulfur.

#### **3. Compaction**

It is very important to minimize compaction of both the base of the bioretention area and the required backfill. When possible, use excavation hoes to remove original soil. If bioretention areas are excavated using a loader, the contractor should use wide track or marsh track equipment, or light equipment with turf type tires. Use of equipment with narrow tracks or narrow tires, rubber tires with large lugs, or high pressure tires will cause excessive compaction resulting in reduced

infiltration rates and is not acceptable. Compaction will significantly contribute to design failure.

Compaction can be alleviated at the base of the bioretention facility by using a primary tilling operation such as a chisel plow, ripper, or subsoiler. These tilling operations are to refracture the soil profile through the 12 inch compaction zone. Substitute methods must be approved by the engineer. Rototillers typically do not till deep enough to reduce the effects of compaction from heavy equipment.

Rototill 2 to 3 inches of sand into the base of the bioretention facility before backfilling the optional sand layer. Pump any ponded water before preparing (rototilling) base.

When backfilling the topsoil over the sand layer, first place 3 to 4 inches of topsoil over the sand, then rototill the sand/topsoil to create a gradation zone. Backfill the remainder of the topsoil to final grade.

When backfilling the bioretention facility, place soil in lifts 12" to 18". Do not use heavy equipment within the bioretention basin. Heavy equipment can be used around the perimeter of the basin to supply soils and sand. Grade bioretention materials with light equipment such as a compact loader or a dozer/loader with marsh tracks.

#### **4. Plant Material**

Recommended plant material for bioretention areas can be found in Appendix A, Section A.2.3.

#### **5. Plant Installation**

Mulch should be placed to a uniform thickness of 2" to 3". Shredded hardwood mulch is the only accepted mulch. Pine mulch and wood chips will float and move to the perimeter of the bioretention area during a storm event and are not acceptable. Shredded mulch must be well aged (6 to 12 months) for acceptance.

Root stock of the plant material shall be kept moist during transport and on-site storage. The plant root ball should be planted so 1/8<sup>th</sup> of the ball is above final grade surface. The diameter of the planting pit shall be at least six inches larger than the diameter of the planting ball. Set and maintain the plant straight during the entire planting process. Thoroughly water ground bed cover after installation.

Trees shall be braced using 2" by 2" stakes only as necessary and for the first growing season only. Stakes are to be equally spaced on the outside of the tree ball.

Grasses and legume seed should be drilled into the soil to a depth of at least one inch. Grass and legume plugs shall be planted following the non-grass ground cover planting specifications.

The topsoil specifications provide enough organic material to adequately supply nutrients from natural cycling. The primary function of the bioretention structure is to improve water quality.

Adding fertilizers defeats, or at a minimum, impedes this goal. Only add fertilizer if wood chips or mulch are used to amend the soil. Rototill urea fertilizer at a rate of 2 pounds per 1000 square feet.

## **6. Underdrains**

Underdrains are to be placed on a 3'-0" wide section of filter cloth. Pipe is placed next, followed by the gravel bedding. The ends of underdrain pipes not terminating in an observation well shall be capped.

The main collector pipe for underdrain systems shall be constructed at a minimum slope of 0.5%. Observation wells and/or clean-out pipes must be provided (one minimum per every 1000 square feet of surface area).

## **7. Miscellaneous**

The bioretention facility may not be constructed until all contributing drainage area has been stabilized.

**Table B.3.2 Materials Specifications for Bioretention**

Material	Specification	Size	Notes
Plantings	see Appendix A, Table A.4	n/a	plantings are site-specific
planting soil [2.5' to 4' deep]	sand 35 - 60% silt 30 - 55% clay 10 - 25%	n/a	USDA soil types loamy sand, sandy loam or loam
mulch	shredded hardwood		aged 6 months, minimum
pea gravel diaphragm and curtain drain	pea gravel: ASTM-D-448  ornamental stone: washed cobbles	pea gravel: No. 6 stone: 2" to 5"	
geotextile	Class "C" - apparent opening size (ASTM-D-4751), grab tensile strength (ASTM-D-4632), puncture resistance (ASTM-D-4833)	n/a	for use as necessary beneath underdrains only
underdrain gravel	AASHTO M-43	0.375" to 0.75"	
underdrain piping	F 758, Type PS 28 or AASHTO M-278	4" to 6" rigid schedule 40 PVC or SDR35	3/8" perf. @ 6" on center, 4 holes per row; minimum of 3" of gravel over pipes; not necessary underneath pipes
poured in place concrete (if required)	MSHA Mix No. 3; $f'_c = 3500$ psi @ 28 days, normal weight, air-entrained; reinforcing to meet ASTM-615-60	n/a	on-site testing of poured-in-place concrete required: 28 day strength and slump test; all concrete design (cast-in-place or pre-cast) <i>not using previously approved State or local standards</i> requires design drawings sealed and approved by a professional structural engineer licensed in the State of Maryland - design to include meeting ACI Code 350.R/89; vertical loading [H-10 or H-20]; allowable horizontal loading (based on soil pressures); and analysis of potential cracking
sand [1' deep]	AASHTO-M-6 or ASTM-C-33	0.02" to 0.04"	Sand substitutions such as Diabase and Graystone #10 are not acceptable. No calcium carbonated or dolomitic sand substitutions are acceptable. No "rock dust" can be used for sand.

### **B.3.C Specifications for Open Channels and Filter Strips**

#### **1. Material Specifications**

The recommended construction materials for open channels and filter strips are detailed in Table B.3.3.

#### **2. Dry Swales**

Permeable soil mixture (20” to 30” deep) should meet the bioretention “planting” soil specifications.

Check dams, if required, shall be placed as specified.

System to have 6” of freeboard, minimum above 2 year water surface elevation.

Side slopes to be 3:1 maximum; (4:1 or flatter is preferred).

No gravel or perforated pipe is to be placed under driveways.

Bottom of facility to be above the seasonally high water table per Table 2 of Appendix D.1.

Seed with flood/drought resistant grasses; see Appendix A, Section 2.4.

Longitudinal slope to be 4%, maximum.

Bottom width to be 8’ maximum to avoid braiding; larger widths may be used if proper berming is supplied. Width to be 2’ minimum.

#### **3. Wet Swales**

Follow above information for dry swales, with the following exceptions: the seasonally high water table may inundate the swale; but not above the design bottom of the channel [NOTE: if the water table is stable within the channel, the  $WQ_v$  storage may start at this point – see Figure 3.19]

Excavate into undisturbed soils; do not use an underdrain system.

#### **4. Filter Strips**

Construct pea gravel diaphragms 12” wide, minimum, and 24” deep minimum.

Pervious berms to be a sand/gravel mix [sand (35-60%), silt (30-55%), and gravel (10-25%)]. Berms to have overflow weirs with 6 inch minimum head.

Slope range to be 2% minimum to 6% maximum.

## **5. Plant Selection**

Recommended grass species for use in establishing permanent ground cover are provided in Section 2.4 of Appendix A.

**Table B.3.3 Open Channel Systems and Filter Strip Materials Specifications**

Material	Specification	Size	Notes
dry swale soil	USCS; ML, SM, SC	n/a	soil with a higher percent organic content is preferred
dry swale sand	ASTM C-33 fine aggregate concrete sand	0.02" to 0.04"	
check dam (pressure treated)	AWPA Standard C6	6" by 6" or 8" by 8"	do not coat with creosote; embed at least 3' into side slopes
check dam (natural wood)	Black Locust, Red Mulberry, Cedars, Catalpa, White Oak, Chestnut Oak, Black Walnut	6" to 12" diameter; notch as necessary	do not use the following, as these species have a predisposition towards rot: Ash, Beech, Birch, Elm, Hackberry, hemlock, Hickories, Maples, Red and Black Oak, Pines, Poplar, Spruce, Sweetgum, Willow
filter strip sand/gravel pervious berm	sand: per dry swale sand gravel; AASHTO M-43	sand: 0.02" to 0.04" gravel: ½" to 1"	mix with approximately 25% loam soil to support grass cover crop; sand (35-60%), silt (30-55%), and gravel (10-25%) see Bioretention planting soil notes for more detail.
pea gravel diaphragm and curtain drain	ASTM D 448	varies (No. 6) or (1/8" to 3/8")	use clean bank-run gravel
underdrain gravel	AASHTO M-43	0.25" to 0.75"	
underdrain	F 758 Type PS 28 or AASHTO M-278	4" to 6" rigid schedule 40 PVC or SDR35	3/8" perf. @ 6" on center, 4 holes per row; minimum of 3" of gravel over pipes; not necessary underneath pipes
geotextile	Class "C" - apparent opening size (ASTM-D-4751), grab tensile strength (ASTM-D-4632), puncture resistance (ASTM-D-4833)	n/a	
rip rap	per county criteria; if none given, use MSHA Standards and Specs Section 905	size per county DOT requirements based on 10-year design flows	

**Appendix**

**B.4**

**Construction Specifications for ESD Practices**





## B.4.A Green Roof Specifications

### 1. Material Specifications

Because there is significant variation in green roof assemblies and methods, providing comprehensive specifications is not feasible. Material specifications for green roofs will vary based on each roofing system and specific information should be obtained from the appropriate manufacturer or retailer. The following information and specifications, which include acceptable materials for generic applications, is not exclusive or limiting.

### 2. Planting Media

Planting media should be a soil-like mixture with an organic content of 15% or less. The grain size distribution is necessary for to attain proper moisture content, permeability, nutrient management and non-capillary porosity, and soil structure. Grain size guidelines vary for single and dual media green roof assemblies.

The planting media shall be tested and meet the following criteria:

- Non-Capillary Pore Space at Field Capacity, 0.333 bar  $\geq 15\%$  (volume)  
(TMECC 03.01, A)
- Moisture Content at Field Capacity  $\geq 12\%$  (volume)  
(TMECC 03.01, A)
- Maximum Media Water Retention (FLL)  $\geq 30\%$  (volume)
- Alkalinity, CaCO<sub>3</sub> equivalents (MSA)  $\leq 2.5\%$
- Total Organic Matter by Wet Combustion (MSA)  $\leq 3-15\%$  (dry wt.)
- pH (RCSTP) 6.5 – 8.0
- Soluble Salts (DTPA saturated media extraction – RCSTP)  $\leq 6$  mmhos/cm
- Cation Exchange Capacity (MSA)  $\geq 10$  meq/100 g
- Saturated Hydraulic Conductivity (FLL):
  - Single Media Assemblies  $\geq 0.05$  in/min
  - Dual Media Assemblies  $\geq 0.30$  in/min
- Mineral Fraction Grain Size Distribution (ASTM D422):

	<u>Single Media</u>	<u>Dual Media</u>
○ Clay Fraction (2 micron)	0	0
○ % Passing #200 Sieve	$\leq 5\%$	5 – 15%
○ % Passing # 60 Sieve	$\leq 10\%$	10 – 25%
○ % Passing #18 Sieve	5 – 50%	20 – 50%
○ % Passing 1/8 inch Sieve	20 – 70%	55 – 90%
○ % Passing 3/8 inch Sieve	75 – 100%	90 – 100%

### 3. Green Roof Layers

Root Barriers – should be thermoplastic membranes with minimum thickness of 30 mils. Membranes certified for use as root barriers are recommended. However, only FLL currently offers a recognized certification test. Many FLL-certified materials are locally available.

Granular Drainage Media – should be a non-carbonate mineral aggregate meeting the following specifications:

- Saturated Hydraulic Conductivity  $\geq 25$  inches/minute
- Total Organic Matter (by wet combustion)  $\leq 1\%$
- Abrasion Resistance (ASTM C131-96)  $\leq 25\%$  loss
- Soundness (ASTM C88 or T103 or T103-91)  $\leq 5\%$  loss
- Porosity (ASTM C29)  $\geq 25\%$
- Alkalinity, CaCO<sub>3</sub> equivalents (MSA)  $\leq 1\%$
- Grain Size Distribution (ASTM C136)
  - Percent Passing #18 Sieve  $\leq 1\%$
  - Percent Passing ¼ inch Sieve  $\leq 30\%$
  - Percent Passing 3/8 inch Sieve  $\leq 80\%$

Separation Fabric – should be a lightweight, non-woven geotextile that is easily penetrated by roots while providing a durable separation between drainage and growth media layers.

Separation fabrics should meet the following:

- Unit Weight (ASTM D3776)  $\leq 4.25$  ounces per square yard
- Grab Tensile Strength (ASTM D4632)  $\leq 90$  lbs.
- Mullen Burst Strength (ASTM D4632)  $\geq 135$  lbs/inch
- Permittivity (ASTM D4491)  $\geq 2$  sec-1

## **B.4.B Specifications for Permeable Pavements & Reinforced Turf**

These specifications include information on acceptable materials for typical applications and are not exclusive or limiting. The designer is responsible for developing detailed specifications for individual projects and specific conditions.

### **1. Pervious Concrete Specifications**

**Design Thickness** - Pervious concrete applications shall be designed so that the thickness of the concrete slab shall support the traffic and vehicle types that will be carried. Applications may be designed using either standard pavement procedures (e.g., AASHTO, ACI 325.9R, ACI 330R) or using structural values derived from flexible pavement design procedures.

**Mix & Installation** – Traditional Portland cements (ASTM C 150, C 1157) may be used in pervious concrete applications. Phosphorus admixtures may also be used. Materials should be tested (e.g., trial batching) prior to construction so that critical properties (e.g., settling time, rate of strength development, porosity, permeability) can be determined.

**Aggregate** – Pervious concrete contains a limited fine aggregate content. Commonly used gradations include ASTM C 33 No. 67 ( $\frac{3}{4}$  in. to No. 4), No. 8 ( $\frac{3}{8}$  in. to No. 16) and No. 89 ( $\frac{3}{8}$  in. to No. 50) sieves. Single-sized aggregate (up to 1 inch) may also be used.

**Water Content** – Water-to-cement ratios between 0.27 and 0.30 are used routinely with proper inclusion of chemical admixtures. Water quality should meet ACI 30a. As a general rule, potable water should be used although recycled concrete production water meeting ASTM C 94 or AASHTO M 157 may also be used.

**Admixtures** – Chemical admixtures (e.g., retarders or hydration-stabilizers) are used to obtain special properties in pervious concrete. Use of admixtures should meet ASTM C 494 (chemical admixtures) and ASTM C 260 (air entraining admixtures) and closely follow manufacturer's recommendations.

**Base Course** – The base course shall be AASHTO No. 3 or 4 course aggregate with an assumed open pore space of 30% ( $n = 0.30$ ).

### **2. Permeable Interlocking Concrete Pavements (PICP)**

**Paver Blocks** – Blocks should be either  $3\frac{1}{8}$  in. or 4 in. thick, and meet ASTM C 936 or CSA A231.2 requirements. Applications should have 20% or more (40% preferred) of the surface area open. Installation should follow manufacturer's instructions, except that infill and base course materials and dimensions specified in this Appendix shall be followed.

**Infill Materials and Leveling Course** – Openings shall be filled with ASTM C-33 graded sand or sandy loam. PICP blocks shall be placed on a one-inch thick leveling course of ASTM C-33 sand.

Base Course - The base course shall be AASHTO No. 3 or 4 course aggregate with an assumed open pore space of 30% ( $n = 0.30$ ).

### **3. Reinforced Turf**

Reinforced Grass Pavement (RGP) – Whether used with grass or gravel, the RGP thickness shall be at least 1¾” thick with a load capacity capable of supporting the traffic and vehicle types that will be carried.

## **B.4.C Specifications for Micro-Bioretenion. Rain Gardens, Landscape Infiltration & Infiltration Berms**

### **1. Material Specifications**

The allowable materials to be used in these practices are detailed in Table B.4.1.

### **2. Filtering Media or Planting Soil**

The soil shall be a uniform mix, free of stones, stumps, roots or other similar objects larger than two inches. No other materials or substances shall be mixed or dumped within the micro-bioretenion practice that may be harmful to plant growth, or prove a hindrance to the planting or maintenance operations. The planting soil shall be free of Bermuda grass, Quackgrass, Johnson grass, or other noxious weeds as specified under COMAR 15.08.01.05.

The planting soil shall be tested and shall meet the following criteria:

- Soil Component - Loamy Sand or Sandy Loam (USDA Soil Textural Classification)
- Organic Content - Minimum 10% by dry weight (ASTM D 2974). In general, this can be met with a mixture of loamy sand (60%-65%) and compost (35% to 40%) or sandy loam (30%), coarse sand (30%), and compost (40%).
- Clay Content - Media shall have a clay content of less than 5%.
- pH Range – Should be between 5.5 - 7.0. Amendments (e.g., lime, iron sulfate plus sulfur) may be mixed into the soil to increase or decrease pH.

There shall be at least one soil test per project. Each test shall consist of both the standard soil test for pH, and additional tests of organic matter, and soluble salts. A textural analysis is required from the site stockpiled topsoil. If topsoil is imported, then a texture analysis shall be performed for each location where the topsoil was excavated.

### **3. Compaction**

It is very important to minimize compaction of both the base of bioretention practices and the required backfill. When possible, use excavation hoes to remove original soil. If practices are

excavated using a loader, the contractor should use wide track or marsh track equipment, or light equipment with turf type tires. Use of equipment with narrow tracks or narrow tires, rubber tires with large lugs, or high-pressure tires will cause excessive compaction resulting in reduced infiltration rates and is not acceptable. Compaction will significantly contribute to design failure.

Compaction can be alleviated at the base of the bioretention facility by using a primary tilling operation such as a chisel plow, ripper, or subsoiler. These tilling operations are to refracture the soil profile through the 12 inch compaction zone. Substitute methods must be approved by the engineer. Rototillers typically do not till deep enough to reduce the effects of compaction from heavy equipment.

Rototill 2 to 3 inches of sand into the base of the bioretention facility before backfilling the optional sand layer. Pump any ponded water before preparing (rototilling) base.

When backfilling the topsoil over the sand layer, first place 3 to 4 inches of topsoil over the sand, then rototill the sand/topsoil to create a gradation zone. Backfill the remainder of the topsoil to final grade.

When backfilling the bioretention facility, place soil in lifts 12" to 18". Do not use heavy equipment within the bioretention basin. Heavy equipment can be used around the perimeter of the basin to supply soils and sand. Grade bioretention materials with light equipment such as a compact loader or a dozer/loader with marsh tracks.

#### **4. Plant Material**

Recommended plant material for micro-bioretention practices can be found in Appendix A, Section A.2.3.

#### **5. Plant Installation**

Compost is a better organic material source, is less likely to float, and should be placed in the invert and other low areas. Mulch should be placed in surrounding to a uniform thickness of 2" to 3". Shredded or chipped hardwood mulch is the only accepted mulch. Pine mulch and wood chips will float and move to the perimeter of the bioretention area during a storm event and are not acceptable. Shredded mulch must be well aged (6 to 12 months) for acceptance.

Rootstock of the plant material shall be kept moist during transport and on-site storage. The plant root ball should be planted so 1/8<sup>th</sup> of the ball is above final grade surface. The diameter of the planting pit shall be at least six inches larger than the diameter of the planting ball. Set and maintain the plant straight during the entire planting process. Thoroughly water ground bed cover after installation.

Trees shall be braced using 2" by 2" stakes only as necessary and for the first growing season only. Stakes are to be equally spaced on the outside of the tree ball.

Grasses and legume seed should be drilled into the soil to a depth of at least one inch. Grass and legume plugs shall be planted following the non-grass ground cover planting specifications.

The topsoil specifications provide enough organic material to adequately supply nutrients from natural cycling. The primary function of the bioretention structure is to improve water quality. Adding fertilizers defeats, or at a minimum, impedes this goal. Only add fertilizer if wood chips or mulch are used to amend the soil. Rototill urea fertilizer at a rate of 2 pounds per 1000 square feet.

## **6. Underdrains**

Underdrains should meet the following criteria:

- Pipe- Should be 4" to 6" diameter, slotted or perforated rigid plastic pipe (ASTMF 758, Type PS 28, or AASHTO-M-278) in a gravel layer. The preferred material is slotted, 4" rigid pipe (e.g., PVC or HDPE).
- Perforations - If perforated pipe is used, perforations should be 3/8" diameter located 6" on center with a minimum of four holes per row. Pipe shall be wrapped with a 1/4" (No. 4 or 4x4) galvanized hardware cloth.
- Gravel – The gravel layer (No. 57 stone preferred) shall be at least 3" thick above and below the underdrain.
- The main collector pipe shall be at a minimum 0.5% slope.
- A rigid, non-perforated observation well must be provided (one per every 1,000 square feet) to provide a clean-out port and monitor performance of the filter.
- A 4" layer of pea gravel (1/8" to 3/8" stone) shall be located between the filter media and underdrain to prevent migration of fines into the underdrain. This layer may be considered part of the filter bed when bed thickness exceeds 24".

The main collector pipe for underdrain systems shall be constructed at a minimum slope of 0.5%. Observation wells and/or clean-out pipes must be provided (one minimum per every 1000 square feet of surface area).

## **7. Miscellaneous**

These practices may not be constructed until all contributing drainage area has been stabilized

<b>Table B.4.1 Materials Specifications for Micro-Bioretention, Rain Gardens &amp; Landscape Infiltration-</b>			
<b>Material</b>	<b>Specification</b>	<b>Size</b>	<b>Notes</b>
Plantings	see Appendix A, Table A.4	n/a	plantings are site-specific
Planting soil [2' to 4' deep]	loamy sand (60 - 65%) & compost (35 - 40%) or sandy loam (30%), coarse sand (30%) & compost (40%)	n/a	USDA soil types loamy sand or sandy loam; clay content < 5%
Organic content	Min. 10% by dry weight (ASTM D 2974)		
Mulch	shredded hardwood		aged 6 months, minimum; no pine or wood chips
Pea gravel diaphragm	pea gravel: ASTM-D-448	NO. 8 OR NO. 9 (1/8" TO 3/8")	
Curtain drain	ornamental stone: washed cobbles	stone: 2" to 5"	
Geotextile		n/a	PE Type 1 nonwoven
Gravel (underdrains and infiltration berms)	AASHTO M-43	NO. 57 OR NO. 6 AGGREGATE (3/8" to 3/4")	
Underdrain piping	F 758, Type PS 28 or AASHTO M-278	4" to 6" rigid schedule 40 PVC or SDR35	Slotted or perforated pipe; 3/8" perf. @ 6" on center, 4 holes per row; minimum of 3" of gravel over pipes; not necessary underneath pipes. Perforated pipe shall be wrapped with 1/4-inch galvanized hardware cloth
Poured in place concrete (if required)	MSHA Mix No. 3; $f'_c = 3500$ psi @ 28 days, normal weight, air-entrained; reinforcing to meet ASTM-615-60	n/a	on-site testing of poured-in-place concrete required: 28 day strength and slump test; all concrete design (cast-in-place or pre-cast) <i>not using previously approved State or local standards</i> requires design drawings sealed and approved by a professional structural engineer licensed in the State of Maryland - design to include meeting ACI Code 350.R/89; vertical loading [H-10 or H-20]; allowable horizontal loading (based on soil pressures); and analysis of potential cracking
Sand	AASHTO-M-6 or ASTM-C-33	0.02" to 0.04"	Sand substitutions such as Diabase and Graystone ( <b>AASHTO</b> ) #10 are not acceptable. No calcium carbonated or dolomitic sand substitutions are acceptable. No "rock dust" can be used for sand.



**Appendix  
C.1**

**Design Example 1 – Shallow Wetland (W-1)**

### **Design Example 1 – Shallow Wetland (W-1)**

The following example demonstrates the process for the design of a shallow wetland (W-1) BMP.

#### **Site Specific Data**

Clevenger Community Center is a recreational center located in Charles County, Maryland. The site area and drainage area to the proposed stormwater management facility is 5.3 acres. The project consists of constructing the community center and parking for a total impervious area of 1.94 acres. Existing ground at the outlet of the facility is 44.5' above mean sea level (MSL). Soil borings indicate that the seasonally high water table is at elevation 41'. The underlying soils are loams. TR-55 calculations for the existing and developed hydrologic conditions are shown in Figures C.1.2 and C.1.3.

#### **Confirm Design Criteria**

The site is within the Eastern Rainfall Zone and located on the Western Shore of the Chesapeake Bay (see Volume I, Chapter 2, Figures 2.1 and 2.4). Additionally, the site is located within a USE I watershed. Therefore, the following criteria apply:

1.  $WQ_v$  treatment is required. In the Eastern Rainfall Zone,  $P = 1''$ .
2.  $Re_v$  treatment is required.
3.  $Cp_v$  treatment is required.
4.  $Q_{p10}$  may be required by the local jurisdiction. For this example,  $Q_{p10}$  will be required.
5.  $Q_f$  may be required by the local jurisdiction. For this example,  $Q_f$  will not be required. However, safe conveyance of the 100-year design storm is required through the proposed stormwater management facility.

#### **Preliminary Design**

##### Step 1. Compute $WQ_v$

Step 1a. Compute Volumetric Runoff Coefficient ( $R_v$ )

$$\begin{aligned} R_v &= 0.05 + (0.009)(I); I = 1.94 \text{ acres} / 5.3 \text{ acres} = 0.366 \text{ or } 36.6\% \\ &= 0.05 + (0.009)(36.6) = 0.379 \end{aligned}$$

Step 1b. Compute  $WQ_v$

$$\begin{aligned} WQ_v &= [(P)(R_v)(A)]!12 \\ &= [(1'')(0.379)(5.3 \text{ ac})]!12 \\ &= \underline{0.167 \text{ ac-ft}} \text{ (7,292 cf.)} \end{aligned}$$

Figure C.1.1 Clevenger Community Center Site Plan

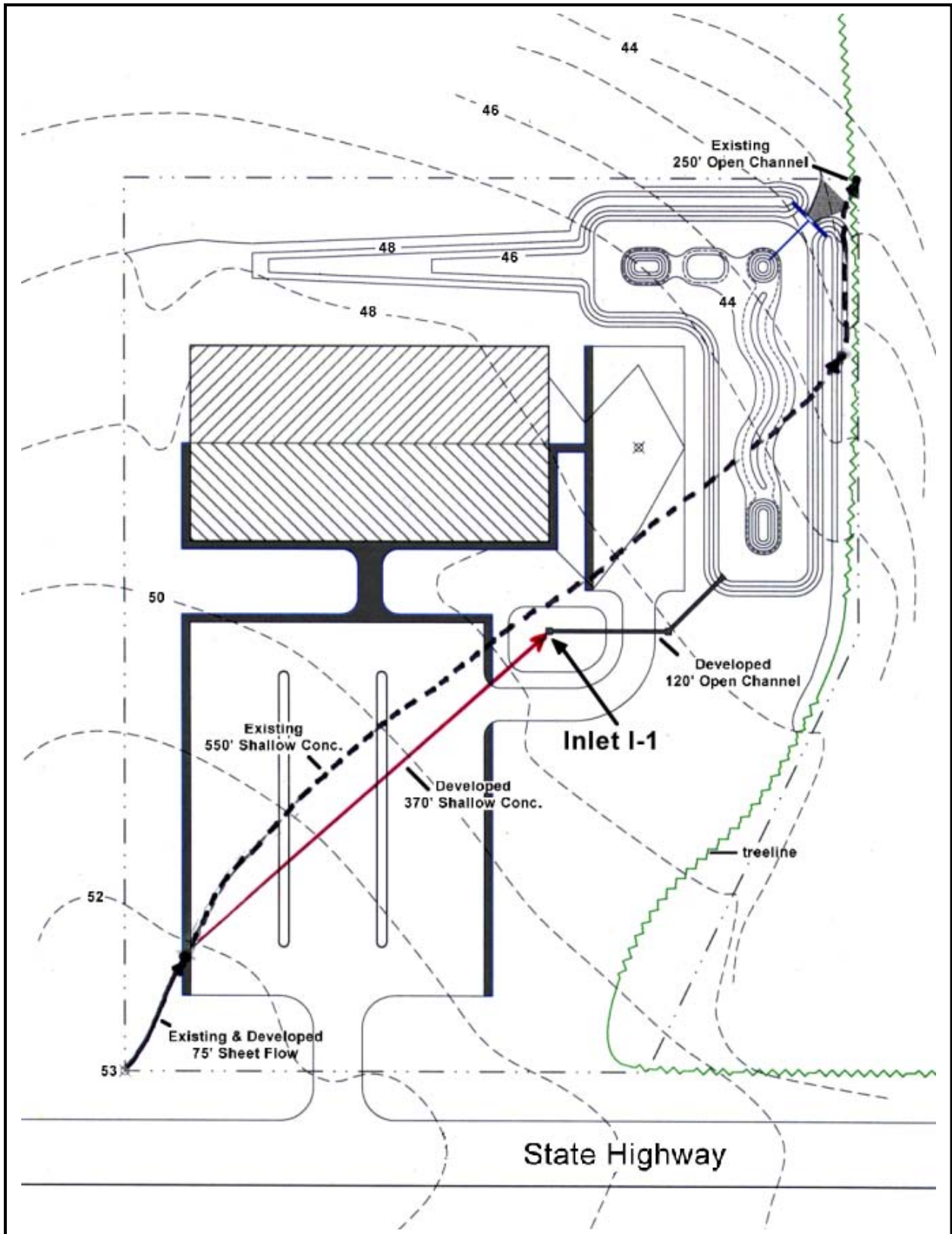

Appendix C.1. Design Example 1 – Shallow Wetland (W-1)

**Figure C.1.2** Clevenger Community Center – Existing Conditions  
(source: TR-55 computer printouts)

```

RUNOFF CURVE NUMBER COMPUTATION                               Version 2.00
Project : CLEVINGER COMMUNITY CENTER                         User: SRC           Date: 06-18-99
County  : CHARLES                                           State: MD           Checked: _____ Date: _____
Subtitle: EXISTING
-----
Hydrologic Soil Group
COVER DESCRIPTION                                           A           B           C           D
Acres (CN)
-----
OTHER AGRICULTURAL LANDS
Meadow -cont. grass (non grazed) ----                -   5.0(58)   -   -
Woods                                           good                -   0.3(55)   -   -
Total Area (by Hydrologic Soil Group)                5.3
-----
TOTAL DRAINAGE AREA: 5.3 Acres           WEIGHTED CURVE NUMBER: 58*
-----
* - Generated for use by GRAPHIC method

TIME OF CONCENTRATION AND TRAVEL TIME                       Version 2.00
-----
Flow Type  2 year  Length  Slope  Surface  n  Area  Wp  Velocity  Time
rain      (ft)    (ft/ft)  code  (sq/ft) (ft) (ft/sec) (hr)
-----
Sheet      3.3     75      0.013  F                                0.221
Shallow Concent'd  550    0.016  U                                0.075
Open Channel      250                                4.0    0.017
                                                    Time of Concentration = 0.31*
--- Sheet Flow Surface Codes ---
A Smooth Surface          F Grass, Dense      --- Shallow Concentrated ---
B Fallow (No Res.)       G Grass, Burmuda   --- Surface Codes      ---
C Cultivated < 20 % Res. H Woods, Light     P Paved
D Cultivated > 20 % Res. I Woods, Dense       U Unpaved
E Grass-Range, Short     J Range, Natural
* - Generated for use by GRAPHIC method

GRAPHICAL PEAK DISCHARGE METHOD                               Version 2.00
Data: Drainage Area      : 5.3 * Acres
Runoff Curve Number     : 58 *
Time of Concentration: 0.31 * Hours
Rainfall Type           : II
Pond and Swamp Area     : NONE
=====
| Storm Number | 1 | 2 | 3 | 4 | 5 | 6 | 7 |
|-----|---|---|---|---|---|---|---|
| Frequency (yrs) | 1 | 2 | 5 | 10 | 25 | 50 | 100 |
| 24-Hr Rainfall (in) | 2.7 | 3.3 | 4.4 | 5.3 | 6 | 6.6 | 7.5 |
| Ia/P Ratio | 0.54 | 0.44 | 0.33 | 0.27 | 0.24 | 0.22 | 0.19 |
| Used | 0.50 | 0.44 | 0.33 | 0.27 | 0.24 | 0.22 | 0.19 |
| Runoff (in) | 0.18 | 0.38 | 0.85 | 1.34 | 1.76 | 2.14 | 2.76 |
| Unit Peak Discharge (cfs/acre/in) | 0.460 | 0.615 | 0.835 | 0.904 | 0.929 | 0.946 | 0.967 |
| Pond and Swamp Factor | 1.00 | 1.00 | 1.00 | 1.00 | 1.00 | 1.00 | 1.00 |
| 0.0% Ponds Used |
|-----|---|---|---|---|---|---|---|
| Peak Discharge (cfs) | 0 | 1 | 4 | 6 | 9 | 11 | 14 |
|-----|---|---|---|---|---|---|---|
* - Value(s) provided from TR-55 system routines

```

Appendix C.1. Design Example 1 – Shallow Wetland (W-1)

**Figure C.1.3** Clevenger Community Center – Developed Conditions  
(source: TR-55 computer printouts)

RUNOFF CURVE NUMBER COMPUTATION				Version 2.00					
Project :	CLEVENGER COMMUNITY CENTER	User:	SRC	Date:	06-18-99				
County :	CHARLES	State:	MD	Checked:	_____	Date:	_____		
Subtitle:	DEVELOPED								
-----									
				Hydrologic Soil Group					
COVER DESCRIPTION	A	B	C	D					
Acres (CN)									
-----									
FULLY DEVELOPED URBAN AREAS (Veg Estab.)									
Open space (Lawns, parks etc.)									
Good condition; grass cover > 75%	-	3.06(61)	-	-					
Impervious Areas									
Paved parking lots, roofs, driveways	-	1.94(98)	-	-					
OTHER AGRICULTURAL LANDS									
Woods	good	-	0.3(55)	-					
Total Area (by Hydrologic Soil Group)	5.3								
-----									
TOTAL DRAINAGE AREA: 5.3 Acres				WEIGHTED CURVE NUMBER: 74*					
-----									
* - Generated for use by GRAPHIC method									
TIME OF CONCENTRATION AND TRAVEL TIME				Version 2.00					
-----									
Flow Type	2 year rain	Length (ft)	Slope (ft/ft)	Surface code	n	Area (sq/ft)	Wp (ft)	Velocity (ft/sec)	Time (hr)
-----									
Sheet	3.3	70	0.013	F					0.209
Shallow Concent'd		310	0.013	P					0.037
Open Channel							5.0		0.007
					Time of Concentration = 0.26*				
--- Sheet Flow Surface Codes ---									
A Smooth Surface	F Grass, Dense			--- Shallow Concentrated ---					
B Fallow (No Res.)	G Grass, Bermuda			--- Surface Codes ---					
C Cultivated < 20 % Res.	H Woods, Light			P Paved					
D Cultivated > 20 % Res.	I Woods, Dense			U Unpaved					
E Grass-Range, Short	J Range, Natural								
* - Generated for use by GRAPHIC method									
GRAPHICAL PEAK DISCHARGE METHOD				Version 2.00					
Data: Drainage Area	: 5.3 * Acres								
Runoff Curve Number	: 74 *								
Time of Concentration:	: 0.26 * Hours								
Rainfall Type	: II								
Pond and Swamp Area	: NONE								
=====									
Storm Number	1	2	3	4	5	6	7		
-----									
Frequency (yrs)	1	2	5	10	25	50	100		
24-Hr Rainfall (in)	2.7	3.3	4.4	5.3	6	6.6	7.5		
Ia/P Ratio	0.26	0.21	0.16	0.13	0.12	0.11	0.09		
Used	0.26	0.21	0.16	0.13	0.12	0.11	0.10		
Runoff (in)	0.72	1.10	1.90	2.61	3.18	3.70	4.48		
Unit Peak Discharge (cfs/acre/in)	0.995	1.033	1.076	1.098	1.110	1.119	1.124		
Pond and Swamp Factor	1.00	1.00	1.00	1.00	1.00	1.00	1.00		
0.0% Ponds Used									
-----									
Peak Discharge (cfs)	4	6	11	15	19	22	27		
=====									
* - Value(s) provided from TR-55 system routines									

Step 2. Compute  $Re_v$

Step 2a. Determine Soil Specific Recharge Factor ( $S$ ) Based on Hydrologic Soil Group

Soils found throughout the site are loams and silt loams therefore  $S = 0.26$

Step 2b. Compute  $Re_v$  Using Percent Volume Method

$$\begin{aligned} Re_v &= [(S)(R_v)(A)]!12 \\ &= [(0.26)(0.379)(5.3)]!12 \\ &= \underline{0.0456 \text{ ac-ft.}} (1,986 \text{ cf}) \end{aligned}$$

Step 2c. Compute  $Re_v$  Using Percent Area Method

$$\begin{aligned} Re_v &= (S)(A_i) \\ &= (0.26)(1.94 \text{ ac.}) \\ &= 0.50 \text{ acres} \end{aligned}$$

The  $Re_v$  requirement may be met by: a) treating 1,986 cf using structural methods, b) treating 0.50 acres using non-structural methods, or c) a combination of both (e.g. 994 cf structurally and 0.25 acres non-structurally).

Step 3. Compute  $Cp_v$

The proposed community center is located within a USE I watershed, therefore an extended detention time ( $T$ ) of 24 hours for the one-year storm event. The time of concentration ( $t_c$ ) and one-year runoff ( $Q_a$ ) are 0.26 hours and 0.72” respectively (see Fig. C.1.3).

Use the MDE Method to Compute Storage Volume (Appendix D.11):

Initial abstraction ( $I_a$ ) for CN of 74 is 0.703: (TR-55) [ $I_a = (200/CN)-2$ ]

$$\begin{aligned} I_a/P &= (0.703)!2.7” = 0.26 \\ t_c &= 0.26 \text{ hours} \end{aligned}$$

$q_u = 625 \text{ csm/in.}$  (Figure D.11.1, Appendix D.11)

$$\begin{aligned} q_i &= q_u A Q_a \quad \text{where } A \text{ is the drainage area in square miles} \\ &= (625 \text{ csm})(0.0083 \text{ square miles})(0.72”) \\ &= 3.7 \text{ cfs; } q_i > 2.0 \text{ cfs } \therefore Cp_v \text{ is required.} \end{aligned}$$

Knowing  $q_u$  and  $T$  (extended detention time), find  $q_o/q_i$  from Figure D.11.2, “Detention Time Versus Discharge Ratios.”

Peak outflow discharge / peak inflow discharge ( $q_o/q_i$ ) = 0.030

## Appendix C.1. Design Example 1 – Shallow Wetland (W-1)

---

With  $q_o/q_i$ , compute  $V_s!V_r$  for a Type II rainfall distribution,

$$V_s!V_r = 0.683 - 1.43(q_o/q_i) + 1.64(q_o/q_i)^2 - 0.804(q_o/q_i)^3 ; \text{ (Appendix D.11)}$$
$$V_s!V_r = 0.64$$

Therefore,  $V_s = [(V_s!V_r)(Q_a)(A)] ! 12$

$$= [(0.64)(0.72'')(5.3 \text{ ac.})] ! 12$$
$$= 0.204 \text{ ac-ft (8,886 cf.)}$$

With  $q_o/q_i$ , compute the  $C_{pv}$  release rate,

$$q_o = (q_o/q_i)(q_i); q_i = 4.0 \text{ cfs}$$
$$= (0.030)(4.0 \text{ cfs})$$
$$= 0.12 \text{ cfs}$$

With  $q_o$ , determine the required orifice area ( $A_o$ ) for extended detention design:

$$A_o = \frac{q_o}{C\sqrt{2gh_o}} = \frac{q_o}{4.81\sqrt{h_o}}$$

“ $h_o$ ” is the maximum storage depth associated with  $V_s$ . For this example, assume  $h_o$  to be no more than 3.0 ft.

$$\therefore A_o = (0.12 \text{ cfs}) ! (4.81\sqrt{3.0 \text{ ft}})$$
$$= (0.12 \text{ cfs}) ! (8.33 \text{ ft})$$
$$= 0.014 \text{ sf.}$$

With  $A_o$ , determine the required orifice diameter ( $d_o$ ):

$$d_o = \sqrt{\frac{4A_o}{\pi}} = \sqrt{\frac{4 \times 0.014 \text{ sf}}{\pi}} = 0.134 \text{ ft} \quad (1.6'') \text{ USE } 1.5''$$

“ $d_o$ 's” of less than 3” are subject to local jurisdictional approval, and are not recommended unless an internal control for orifice protection is used. For this example, use a  $d_o$  of 3”.

### Step 4. Compute $Q_{p10}$ Storage Volume

Per TR-55, Figure 6-1 (Page 6-2 of TR-55) for an inflow ( $Q_{in}$ ) of 15 cfs and an allowable outflow ( $Q_{out}$ ) of 6 cfs, the volume of storage ( $V_s$ ) necessary for control is 0.37 ac-ft, with a developed CN of 74 (see TR-55 Worksheet 6a, Page 6-5 of TR-55). Note that there is 5.3 inches of rainfall during this event with 2.6 inches of runoff.

### Step 5. Compute $Q_f$

For this example, management of  $Q_f$  is not required. However, the 100-year storm event must be

conveyed safely through the stormwater management practice.

**Table C.1.1** Summary of General Storage Requirements for Clevenger Community Center

Step	Requirement	Volume Required (acre-feet)	Notes
1.	$WQ_v$	0.167	
2.	$Re_v$	0.0456 (or 0.50 acres)	volume is included within the $WQ_v$ storage
3.	$Cp_v$	0.204	$Cp_v$ release rate is 0.10 cfs
4.	$Q_{p10}$	0.36	10-year release rate is 6.0 cfs
5.	$Q_f$	N/A	provide safe passage for the 100-year event in final design

## Final Design

### Step 1. BMP Selection Process

While the stormwater management BMP's listed in Chapter 2.7 (Volume I) are equivalent in meeting the established pollutant removal goals, site characteristics are an important consideration in selecting the most appropriate BMP for a specific design. The process outlined in Chapter 4 (Volume I) provides guidance for screening BMP's as part of the selection process.

- ∂ **Watershed Factors: Is the project located in a watershed that has special design objectives or constraints that must be met?** This project is located in a USE I watershed and there are no other special objectives or constraints that must be considered.
- **Terrain Factors: Is the project located in a portion of the State that has particular design constraints imposed by local terrain and or underlying geology?** The project is located in a region of the State that has no constraints imposed by local terrain or underlying geology
- ÷ **Stormwater Treatment Suitability: Can the BMP meet all five stormwater criteria at the site or are a combination of BMPs needed?** For this project, a single BMP will not satisfy all of the required criteria (see Table 4.3 BMP Selection Matrix No. 3). Therefore, one BMP will treat  $WQ_v$ ,  $Cp_v$ , and  $Q_{p10}$  while a separate BMP will treat  $Re_v$ .



## Appendix C.1. Design Example 1 – Shallow Wetland (W-1)

---

- ≠ **Physical Feasibility Factors: Are there any physical constraints at the project site that may restrict or preclude the use of a particular BMP?** Although the soils encountered are infiltratable, the depth to the existing water table is less than 4.0'. Therefore infiltration is not feasible for treating  $WQ_v$ . Additionally, the soils indicate that wet pond designs may require a liner. Sand filters will require substantial pretreatment as the proposed imperviousness is near 37%. The drainage area, 5.3 acres, is marginally low to support either ponds or wetlands. However, the groundwater table may be sufficient to support a shallow wetland.
- ≡ **Community and Environmental Factors: Do the remaining BMPs have any important community or environmental benefits or drawbacks that might influence the selection process?** The projected use of the site as a community center may require that BMPs possess a greater acceptance by the community. Additionally, habitat quality is important if environmental education is provided at the center. Finally, ease of maintenance and costs relative to drainage area are important considerations as the sources of future funding may be limited.
- ≈ **Location and Permitting Factors: What environmental features must be avoided or considered when locating the BMP system at a site to fully comply with local, State and federal regulations?** There are no wetlands, stream buffers, floodplains or forest conservation areas located on the site although the area of existing woods should be preserved if possible.

After considering all factors and the site layout, use a shallow wetland (W-1) for treating  $WQ_v$ .  $Cp_v$  and  $Q_{p10}$  will be treated by providing sufficient storage above the shallow wetland. Finally,  $Re_v$  will be treated prior to the wetland by providing storage around the inlet, I-1.

### Step 2. Shallow Wetland (W-1) Design

Using the information developed in Preliminary Design Steps 1 and 2, design a shallow wetland to treat  $WQ_v$  (see Figure C.1.4).

#### A. Calculate Design Volume

Because  $Re_v$  will be treated prior to the shallow wetland,  $Re_v$  may be subtracted from the  $WQ_v$  for the design of this BMP:

$$\begin{aligned}WQ_{v,9} &= WQ_v - Re_v \\ &= 7,292 \text{ cf.} - 1,986 \text{ cf.} \\ &= 5,306 \text{ cf.}\end{aligned}$$

## Appendix C.1. Design Example 1 – Shallow Wetland (W-1)

---

### B. Calculate Pretreatment (Forebay) Volume

Forebays shall be sized to capture 10% of the design runoff volume (in this case  $WQ_v9$ ) at each inflow point; assume that inflow is divided equally between the two inflow points for this design.

$$\begin{aligned}\text{forebay volume} &= (10\%)(5,306 \text{ cf.} / 2) \\ &= 265.3 \text{ cf. at each inflow point}\end{aligned}$$

$$\text{forebay volume provided} = 800 \text{ cf. and } 700 \text{ cf. respectively}$$

### B. Determine Shallow Wetland Size Criteria

Using the design criteria set forth in Chapter 3 for the design of shallow wetland systems, the configuration shown in Figure C.1.4, and the information in Table C.1.2, design a shallow wetland to treat  $WQ_v9$ . Specific criteria that govern the configuration of the shallow wetland design are as follows.

1. Surface area  $\langle 1.5\% \text{ } \rangle$  drainage area  
 $\langle 1.5\% \text{ } \rangle$  5.3 acres  
 $\langle 0.0795 \text{ acres } \rangle$  (3,463 sf.)

$$\text{Surface area of shallow wetland at elevation } 44.0 = 0.1366 \text{ acres } (5,950 \text{ sf.}) \text{ -OKAY}$$

2. Deepwater (depth  $\langle 4' \rangle$ ) zones  $\langle 25\% \text{ } \rangle$   $WQ_v9$   
 $\langle 25\% \text{ } \rangle$  5,306 cf.  
 $\langle 1,326.5 \text{ cf.} \rangle$

$$\text{Deepwater zones provided} = 1,950 \text{ cf. (forebays and micropool)}$$

3. High marsh (depth  $\langle 6'' \rangle$ ) zones  $\langle 35\% \text{ } \rangle$  total surface area  
 $\langle 35\% \text{ } \rangle$  3,463 sf.  
 $\langle 1,212.1 \text{ sf.} \rangle$

$$\text{High marsh area provided} = 2,160 \text{ sf.}$$

4. Total marsh area (depth  $\langle 18'' \rangle$ ) zones  $\langle 65\% \text{ } \rangle$  total surface area  
 $\langle 65\% \text{ } \rangle$  3,463 sf.  
 $\langle 2,251 \text{ sf.} \rangle$

$$\text{Total marsh area provided} = 4,200 \text{ sf.}$$

5. Check for water balance (see Appendix D.3) for maintenance of wet pool:

- a. Calculate maximum drawdown:

## Appendix C.1. Design Example 1 – Shallow Wetland (W-1)

---

Inflow Runoff Volume =  $P \times E$  where  $P$  = Precipitation &  $E$  = Runoff Efficiency

- for a CN of 74, Volume of runoff (2 year storm) = 1.10"

- for Charles County,  $P$  (2 year rainfall) = 3.3" (0.275')

-  $E = 1.1" / 3.3" = 0.33$

∴ Inflow =  $P \times E = 0.275' \times 0.33 \times 5.3 \text{ acres} = 0.48 \text{ ac-ft}$

Outflow = surface area x evaporation losses

= 0.137 acres x 0.54 ft (see Table D.3.2)

= 0.074 ac-ft

Inflow (0.48 ac-ft) is greater than Outflow (0.074 ac-ft) –OKAY

b. Check for drawdown over an extended period without rainfall:

Using 45 day “worst case” drought conditions

- highest evaporation occurs in July – 0.54 ft per month

- average evaporation per day =  $0.54 / 31 \text{ days} = 0.017 \text{ ft/day}$

- over 45 day interval, evaporation loss =  $45 \times 0.017 \text{ ft/day} = 0.78 \text{ ft}$ .

- assume surface of wetland may drop up to 0.78 ft. over this interval -OKAY

**Table C.1.2 Stage – Storage Data for Stormwater Management Design**

Stage - Storage Data				
Elevation	$\Delta$ Storage	Storage (cubic feet)	Storage (acre-feet)	Storage Above $WQ_v$ (acre-feet)
40.0	0.0	0.0	0.0	
41.0	372.0	372.0	0.0085	
42.0	665.0	1,037.0	0.0238	
43.0	1,428.0	2,465.0	0.0566	
44.0	3,990.0	6,455.0	0.1482	0.0
45.0	11,200.0	17,665.0	0.4055	0.2573
45.5	8,478.0	26,133.0	0.5999	0.4517
46.0	8,987.0	35,120.0	0.8062	0.6581
47.0	19,530.0	54,650.0	1.2546	1.1064
48.0	21,646.0	76,296.0	1.7515	1.6033

**Figure C.1.4 Plan View of Shallow Wetland Design**

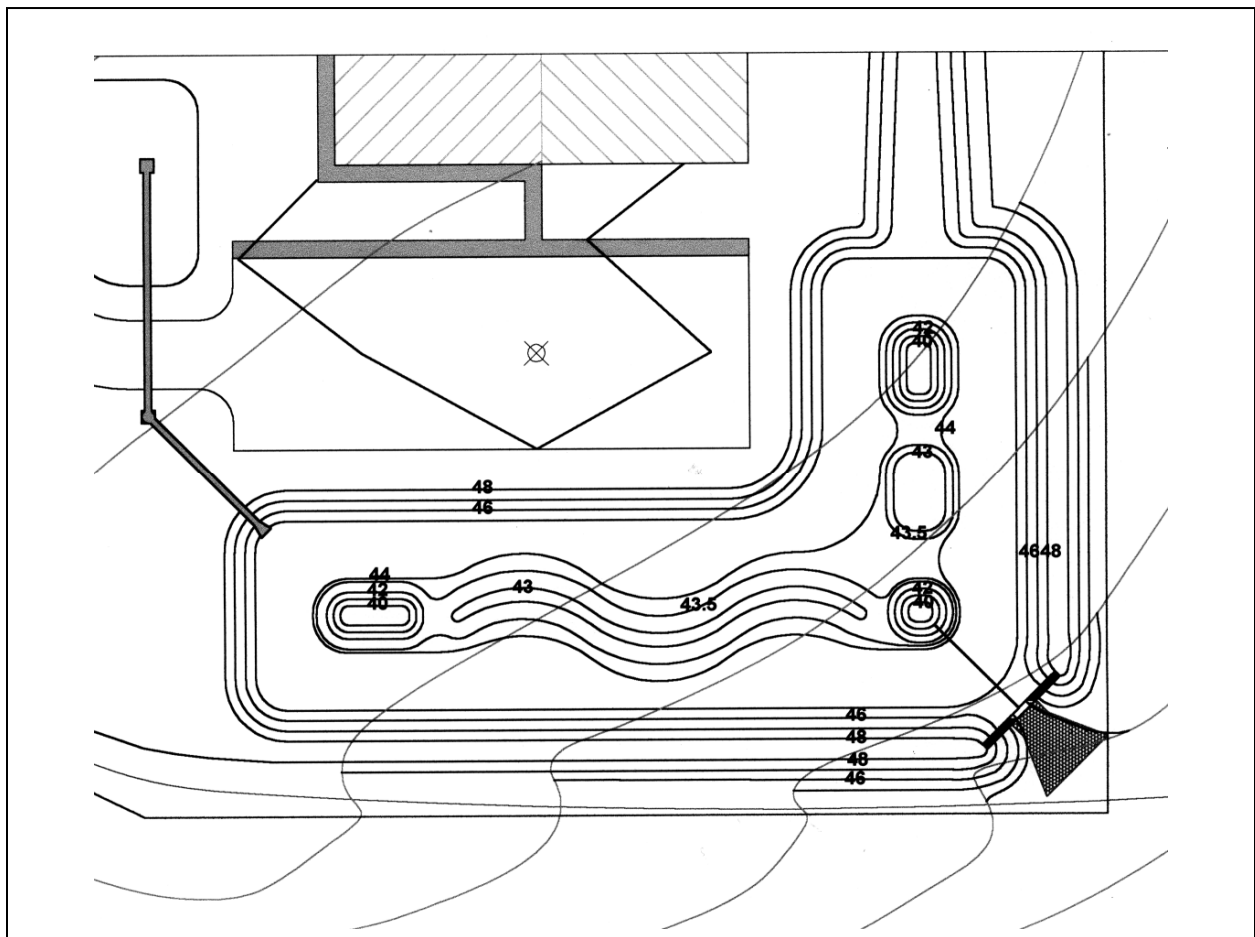

Step 3. Cp<sub>v</sub> Design

Using the information from Preliminary Design Step 3, the stage-storage data from Table C.1.2, and the stage-discharge data for the 3” orifice in Table C.1.3, design an extended-detention basin to treat Cp<sub>v</sub>.

**Table C.1.3 Stage – Discharge Data for Clevenger Community Center**

Stage - Discharge Data							
Elevation	3” Orifice <sup>1</sup> centerline – 44.125’		5.2’ Weir <sup>2</sup> crest @ 45.00’		10.0’ Weir <sup>3</sup> crest @ 45.50’		Total Discharge
	Head (h)	Discharge	Head (h)	Discharge	Head (h)	Discharge	
44.00	0.0	0.00					0.00
44.25	0.1	0.085					0.085
44.50	0.4	0.150					0.150
44.75	0.6	0.194					0.194
45.00	0.9	0.229	0.0	0.0			0.229
45.50	1.4	0.287	0.5	5.70	0.0	0.0	5.70
46.00	1.9	0.335	1.0	16.12	0.5	10.96	27.08
47.00	2.9	0.415	2.0	45.59	1.5	56.95	102.54
48.00	3.9	0.482	3.0	83.76	2.5	122.53	206.29

1. Using orifice equation  $Q = ca\sqrt{2gh}$  where  $c=0.61$ ,  $a=0.05$  sf., and  $g= 32.2$  ft/sec<sup>2</sup>  
 2. Using weir equation  $Q = clh^{3/2}$  where  $c= 3.1$  &  $l=5.2'$   
 3. Using weir equation  $Q = clh^{3/2}$  where  $c= 3.1$  &  $l=10.0'$

From Preliminary Step 3, the storage volume (V<sub>s</sub>) for Cp<sub>v</sub> is 0.204 ac-ft and the required orifice diameter (d<sub>o</sub>) is 3”. Using Table C.1.2 and starting at elevation 44.0, the storage volume of the proposed stormwater management structure is 0.2573 ac-ft at elevation 45.0’. Therefore, Cp<sub>v</sub> treatment will be provided between elevations 44.0’ and 45.0’.

Step 4. Q<sub>p10</sub> Treatment

From Preliminary Step 5, the estimated storage volume (V<sub>s</sub>) for treating Q<sub>p10</sub> is 0.36 ac-ft and the allowable discharge rate is 6.0 cfs. Using Table C.1.2 and starting at elevation 44.0’, the storage volume of the proposed stormwater management structure is 0.4517 ac-ft at elevation 45.5’. Therefore, design a control structure that will produce a discharge rate of 6.0 cfs at storage elevation 45.5’. This will be a conservative design since the volume provided (0.4517 ac-ft) is greater than the 0.36 ac-ft required. Using a weir with crest at elevation 45.0’ and including flow from the 3” orifice, the ten-year discharge (q<sub>10</sub>) may be computed as follows:

$$q_{10} = c_w l h_w^{3/2} + c_o a \sqrt{2gh_o}$$

where:  $q_{10} = 10$  yr. discharge = 6.0 cfs

## Appendix C.1. Design Example 1 – Shallow Wetland (W-1)

---

$c_w$  = weir coefficient = 3.1  
 $l$  = length of weir  
 $h_w$  = head on weir; at elevation 45.5,  $h_w = 0.5'$   
 $c_o$  = orifice coefficient = 0.61  
 $a$  = area of 3" orifice = 0.05  
 $g$  = gravitational acceleration = 32 ft/sec<sup>2</sup>  
 $h_o$  = head on orifice; at elevation 45.5,  $h_o = 1.375$

therefore:  $q_{10} = (3.1)(l)(0.5)^{3/2} + (0.61)(0.05)[(2)(32.2)(1.375)]^{1/2}$   
6.0 cfs = 1.1 $l$  cfs + 0.29 cfs  
by rearranging this equation and solving for  $l$ ;  $l = 5.2'$

use a 5.2' weir with crest at elevation 45.0 –OKAY

### Step 5. $Q_f$ Treatment

From Preliminary Step 5, the 100-year storm event must be conveyed safely through the stormwater management facility. From Figure C.1.3, 100-year discharge rate ( $q_{100}$ ) is 27 cfs and from Figure C.1.4, the top of the proposed stormwater management facility is at elevation 48.0'. Allowing for 2.0' of freeboard, design a control structure that will discharge 27 cfs at elevation 46.0'. Using a weir with crest at elevation 45.5', including flow from the 5.5' weir and assuming that the 3" orifice is clogged,  $q_{100}$  may be computed as follows:

$$q_{100} = cl_{100}h_{100}^{3/2} + cl_{10}h_{10}^{3/2}$$

where:  $q_{100}$  = 100 yr. discharge = 27 cfs.  
 $c$  = weir coefficient = 3.1  
 $l_{100}$  = length of 100 yr. weir  
 $h_{100}$  = head on 100 yr. weir; at elev. 46.0',  $h_{100} = 0.5'$   
 $l_{10}$  = length of 10 yr. weir = 5.2'  
 $h_{10}$  = head on 10 yr. weir; at elev. 46.0',  $h_{10} = 1.0'$

therefore:  $q_{100} = (3.1)(l_{100})(0.5)^{3/2} + (3.1)(5.2')(1.0)^{3/2}$   
27 cfs = 1.1 $l_{100}$  cfs + 16.1 cfs  
by rearranging this equation and solving for  $l_{100}$ ;  $l_{100} = 9.89'$

use a 10.0' weir with crest at elevation 45.5' –OKAY

See Figure C.1.5 for a schematic of the control structure and Figure C.1.6 for a profile through the centerline of the dam and control structure. See Figures C.1.7 and C.1.8 for the TR-20 input and summary tables.

Figure C.1.5 Schematic of Control Structure

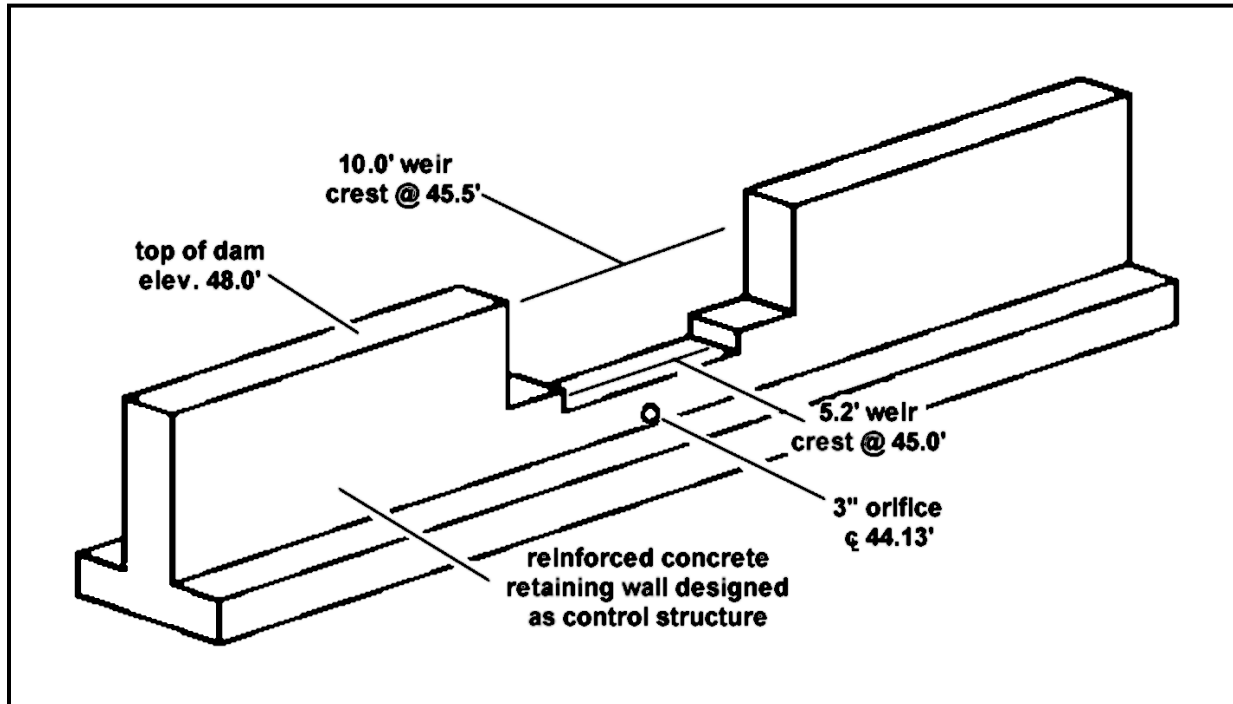

Step 6. Investigate Potential Pond Hazard Classification

Using NRCS-MD Code No. 378 Pond Standards/Specifications (Appendix B.1), review downstream conditions and compute a preliminary Breach Peak Discharge ( $Q_{max}$ ) to determine pond hazard classification.

$$Q_{max} = (3.2)(H_w^{5/2})$$

where:

$Q_{max}$  = Breach Peak Discharge

$H_w$  = depth of water at the dam at time of failure, in feet, and is measured from the design high water to the lowest point in the original cross section at the centerline of the dam;  $H_w = 46.0' - 44.0' = 2.0'$

$$Q_{max} = (3.2)(2.0)^{5/2} = 18.1 \text{ cfs}$$

$Q_{max}$  will not overtop downstream roads or infrastructure, therefore the stormwater management facility may be considered as a Class “a” low hazard structure per the NRCS-MD 378 standards.

Figure C.1.6 Profile of Principle Spillway

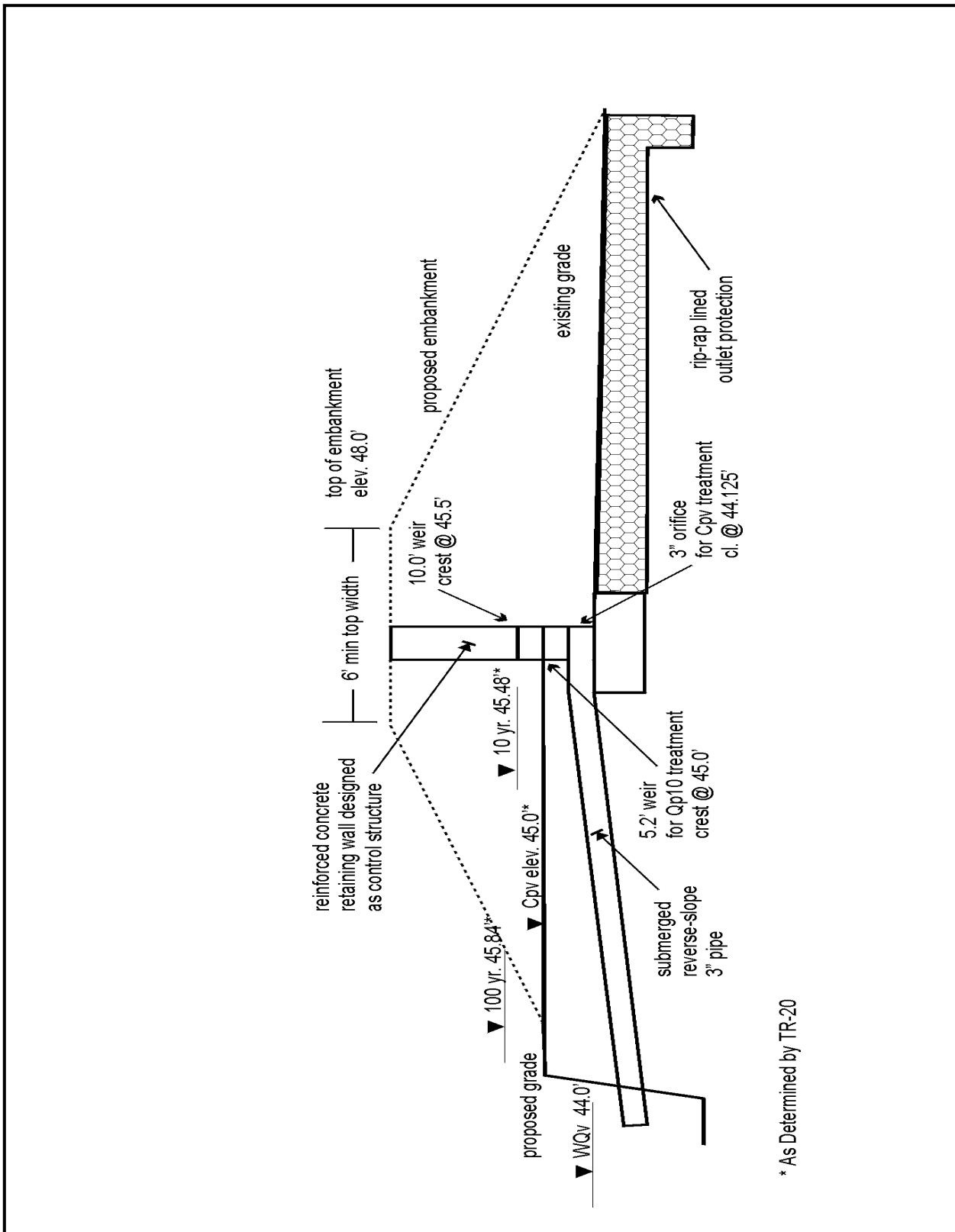



**Figure C.1.7 TR-20 Computer Program Input File**

JOB TR-20	EXAMPLE1	ECON	FULLPRINT	PASS=001	SUMMARY	GRAPHICS
TITLE	DESIGN EXAMPLE 1	CLEVANGER	COMMUNITY	CENTER		
3	STRUCT	01				
8		44.0	0.0	0.0		
8		44.25	0.12	0.060		
8		44.5	0.17	0.128		
8		44.75	0.21	0.180		
8		45.0	0.24	0.2573		
8		45.5	5.70	0.4517		
8		46.0	27.08	0.6581		
8		47.0	102.54	1.1064		
8		48.0	206.29	1.6033		
9	ENDTBL					
6	RUNOFF	1 001	1 .00828	74.	0.26	1 1 1 1 1
6	RESVOR	2 01 1	2 44.0			1 1 1 1 1 1
6	RUNOFF	1 003	3 .00828	58.	0.31	1 1 1 1 1
	ENDATA					
7	INCREM	6	0.10			
7	COMPUT	7 001 003	0.0	2.7	1.0	2 2 01 01
	ENDCMP	1				
7	INCREM	6	0.10			
7	COMPUT	7 001 003	0.0	3.3	1.0	2 2 01 02
	ENDCMP	1				
7	INCREM	6	0.10			
7	COMPUT	7 001 003	0.0	5.3	1.0	2 2 01 10
	ENDCMP	1				
7	INCREM	6	0.10			
7	COMPUT	7 001 003	0.0	7.5	1.0	2 2 01 99
	ENDCMP	1				
	ENDJOB	2				

**Figure C.1.8 TR-20 Computer Program Output Summary Table**

SUMMARY TABLE 1							
-----							
SELECTED RESULTS OF STANDARD AND EXECUTIVE CONTROL IN ORDER PERFORMED.							
A CHARACTER FOLLOWING THE PEAK DISCHARGE TIME AND RATE (CFS) INDICATES:							
F-FLAT TOP HYDROGRAPH    T-TRUNCATED HYDROGRAPH    R-RISING TRUNCATED HYDROGRAPH							
XSECTION/ STRUCTURE ID	STANDARD CONTROL OPERATION	DRAINAGE AREA (SQ MI)	RUNOFF AMOUNT (IN)	PEAK DISCHARGE			
				ELEVATION (FT)	TIME (HR)	RATE (CFS)	RATE (CSM)
-----							
RAINFALL OF		2.70 inches	AND	24.00 hr	DURATION, BEGINS AT	.0 hrs.	
RAINTABLE NUMBER		2,	ARC	2			
MAIN TIME INCREMENT		.100 HOURS					
ALTERNATE		1	STORM	1			
-----							
XSECTION	1	RUNOFF	.01	.72	---	12.07T	4T 400.0
STRUCTURE	1	RESVOR	.01	.71	---	.00	0 .0
XSECTION	3	RUNOFF	.01	.71	---	.00	0 .0
XSECTION	3	RUNOFF	.01	.71	---	.00	0 .0
RAINFALL OF		3.30 inches	AND	24.00 hr	DURATION, BEGINS AT	.0 hrs.	
ALTERNATE		1	STORM	2			
-----							
XSECTION	1	RUNOFF	.01	1.10	---	12.06	7 700.0
STRUCTURE	1	RESVOR	.01	1.09	---	.00	0 .0
XSECTION	3	RUNOFF	.01	.38	---	12.14T	1T 100.0
RAINFALL OF		5.30 inches	AND	24.00 hr	DURATION, BEGINS AT	.0 hrs.	
MAIN TIME INCREMENT		.100 HOURS					
ALTERNATE		1	STORM	10			
-----							
XSECTION	1	RUNOFF	.01	2.60	---	12.05	16 1600.0
STRUCTURE	1	RESVOR	.01	2.59	45.50	12.32	6 600.0
XSECTION	3	RUNOFF	.01	1.34	---	12.10	7 700.0
RAINFALL OF		7.50 inches	AND	24.00 hr	DURATION, BEGINS AT	.0 hrs.	
ALTERNATE		1	STORM	99			
-----							
XSECTION	1	RUNOFF	.01	4.48	---	12.04	28 2800.0
STRUCTURE	1	RESVOR	.01	4.43	45.84	12.18	20 2000.0
XSECTION	3	RUNOFF	.01	2.75	---	12.09	16 1600.0

Step 7.  $Re_v$  Treatment

Using the information developed in Preliminary Step 2, design a structural practice to treat  $Re_v$ . Non-structural practices will not be utilized therefore the entire  $Re_v$  (1,986 cf) must be treated. For this example, design an infiltration area around inlet I-1 (see Figure C.1.9) that will treat the entire  $Re_v$ . Because of its high visibility and the communal nature of the project, this infiltration area will be designed and planted similar to a bioretention area.

The surface area around I-1 that is available for this practice has an area ( $A$ ) of 2,250 sf. Using a porosity ( $n$ ) of 0.30\* for the sand and planting soil mixture, the required depth ( $d$ ) to treat the entire  $Re_v$  is equal to:

$$\begin{aligned} & [(Re_v)/(A)] / n \\ & = [(1,986 \text{ cf.})/(2,250 \text{ sf.})] / 0.30 \\ & = 0.883 / 0.30 \\ & = 2.94 \text{ ft. Use } d = 3.0 \text{ ft.} \end{aligned}$$

\*Note: The porosity of mixed-grained sand varies from 0.30 (dense) to 0.40 (loose). Using the minimum value, 0.30, results in a more conservative design.

Using a depth of 3.0', a surface area of 2,250 sf. and a  $n$  of 0.3, storage for  $Re_v$  treatment is equal to:

$$\begin{aligned} & (A \times d) \times n \\ & = (2,250 \text{ sf.} \times 3.0 \text{ ft.}) \times 0.3 \\ & = 2,025 \text{ cf. -OKAY} \end{aligned}$$

Using the dimensions above, a cross section of the infiltration area is shown in Figure C.1.10.

Step 8. Landscaping

The BMP's for both  $WQ_v$  and  $Re_v$  treatment have specific landscaping requirements for proper implementation. Therefore, landscaping plans developed in accordance with Chapter 3 and using the guidelines provided in Appendix A will be required with submittal of the final design.

Figure C.1.9 Location of Rev Treatment

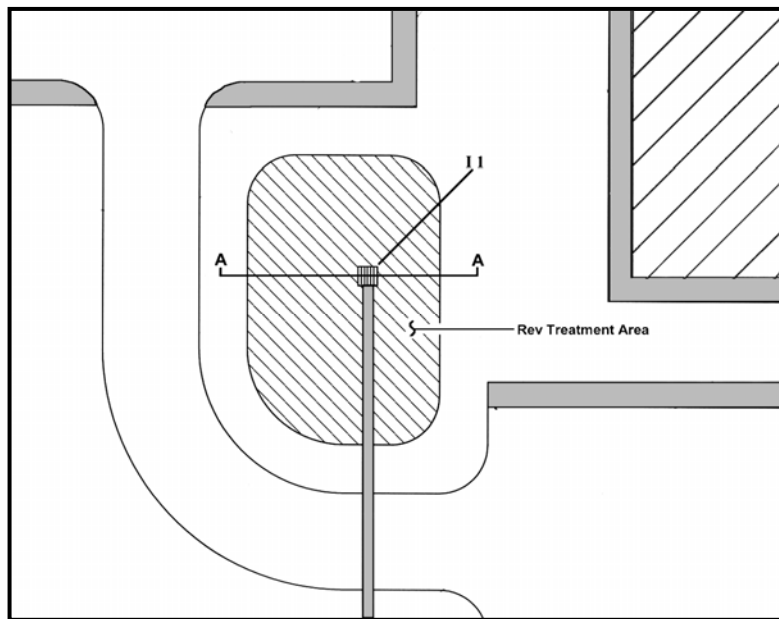
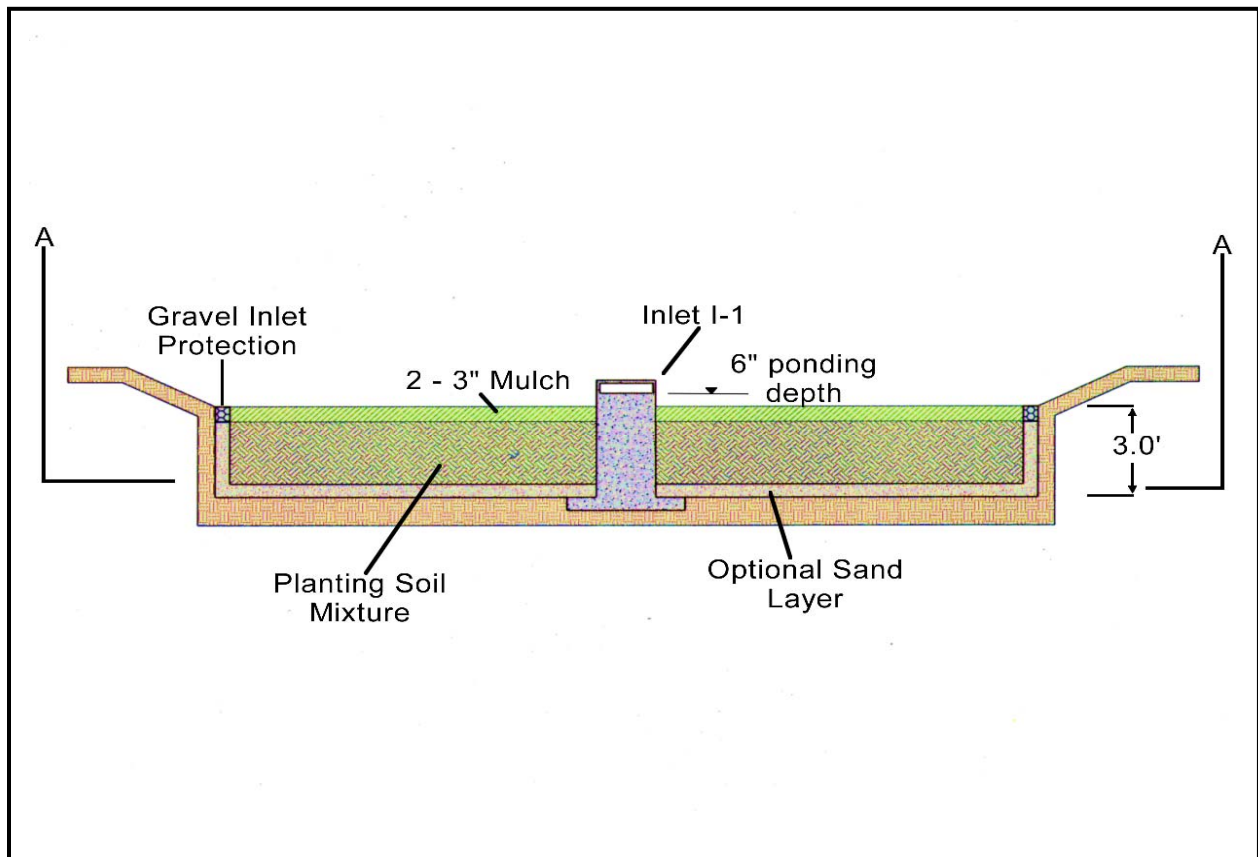

Figure C.1.10 Cross Section "A-A"



**Appendix  
C.2**

**Design Example 2 – Water Quality BMPs**

### Design Example 2 – Water Quality BMPs

The following example demonstrates the design of several different BMPs for  $WQ_v$  and  $Re_v$  treatment including filtering, infiltration, and open channel practices.

Figure C.2.1 Comstock Commercial Center Site Plan

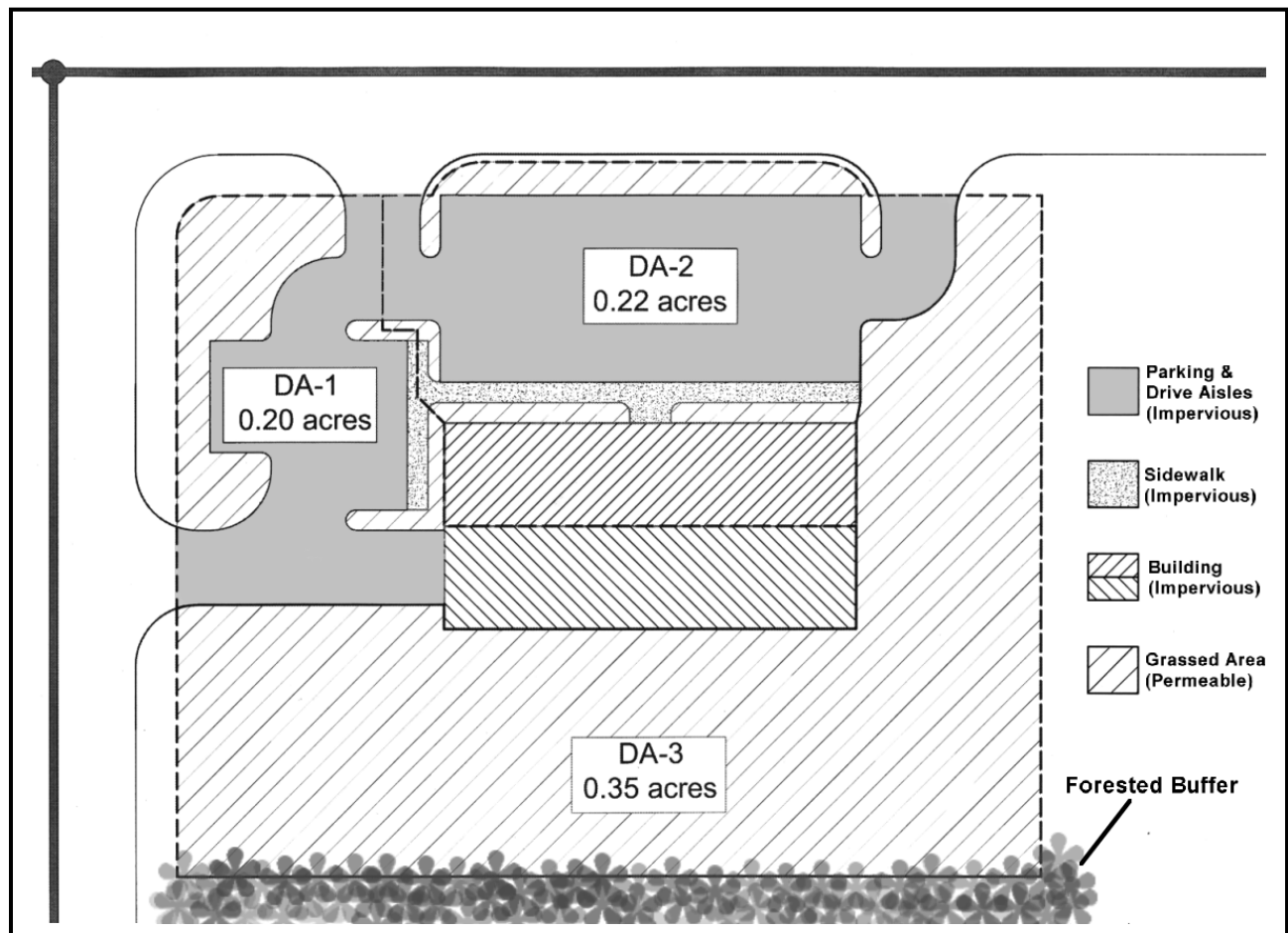

#### Site Specific Data

Comstock Commercial Center is a 0.77 acre retail store located in Howard County, Maryland. The developed area of the site may be divided into two drainage areas of 0.20 and 0.22 acres respectively with a remaining drainage area of 0.35 acres. Total impervious area for the development is 0.36 acres; 0.16 acres in DA-1 and 0.20 acres in DA-2. Existing and proposed topography are not given for this exercise; it may be assumed that these conditions are amenable for each specific design. Likewise, the seasonally high water table will not be a factor in infiltration designs. The underlying soils are loams (HSG B). TR-55 calculations for the developed hydrologic conditions are shown in Figures C.2.2, C.2.3 and C.2.4.

### C.2.1 Design Criteria

The site is within the Eastern Rainfall Zone and located on the Western Shore of the Chesapeake Bay (see Volume I, Chapter 2, Figures 2.1 and 2.4). Additionally, the site is located within a USE I watershed. Therefore, the following criteria apply:

1.  $WQ_v$  treatment is required. In the Eastern Rainfall Zone,  $P = 1''$ .
2.  $Re_v$  treatment is required.
3.  $Cp_v$  treatment is required.
4.  $Q_{p10}$  may be required by the local jurisdiction. For this example,  $Q_{p10}$  will not be required.
5.  $Q_f$  may be required by the local jurisdiction. For this example,  $Q_f$  will not be required. However, safe conveyance of the 100-year design storm is required through the proposed stormwater management facility.

### C.2.2 Preliminary Design

#### Step 1. Compute $WQ_v$

##### Step 1a. Compute Volumetric Runoff Coefficient ( $R_v$ )

$$\begin{aligned} R_v &= 0.05 + (0.009)(I); I = (0.36 \text{ acres} / 0.77 \text{ acres}) = 0.468 \text{ or } 46.8\% \\ &= 0.05 + (0.009)(46.8) = 0.471 \end{aligned}$$

##### Step 1b. Compute $WQ_v$

$$\begin{aligned} WQ_v &= [(P)(R_v)(A)]!12 \\ &= [(1'')(0.471)(0.77 \text{ ac})]!12 \\ &= \underline{0.0302 \text{ ac-ft}} (1,316.5 \text{ cf.}) \end{aligned}$$

Appendix C.2. Design Example 2 – Water Quality BMPs

**Figure C.2.2** Comstock Commercial Center – Developed Conditions  
(source: TR-55 computer printouts)

RUNOFF CURVE NUMBER COMPUTATION				Version 2.10			
Project :	COMSTOCK COMMERCIAL	User:	SRC	Date:	09-17-1999		
County :	HOWARD	State:	MD	Checked:	_____	Date:	_____
Subtitle:	DEVELOPED CONDITIONS						
-----							
COVER DESCRIPTION	Hydrologic Soil Group						
	A	B	C	D			
-----							
FULLY DEVELOPED URBAN AREAS (Veg Estab.)							
Open space (Lawns,parks etc.)							
Good condition; grass cover > 75%	-	0.41(61)	-	-			
Impervious Areas							
Paved parking lots, roofs, driveways	-	0.36(98)	-	-			
-----							
Total Area (by Hydrologic Soil Group)	.77						
-----							
TOTAL DRAINAGE AREA: .77 Acres				WEIGHTED CURVE NUMBER: 78*			
GRAPHICAL PEAK DISCHARGE METHOD				Version 2.10			
-----							
Project :	COMSTOCK COMMERCIAL CENTER	User:	SRC	Date:	12-07-1999		
County :	HOWARD	State:	MD	Checked:	_____	Date:	_____
Subtitle:	DEVELOPED CONDITIONS						
Data: Drainage Area	:	.77	Acres				
Runoff Curve Number	:	78					
Time of Concentration:	0.10	Hours (MINIMUM VALUE)					
Rainfall Type	:	II					
Pond and Swamp Area	:	NONE					
=====							
Storm Number	1	2	3	4	5	6	7
-----	-----	-----	-----	-----	-----	-----	-----
Frequency (yrs)	1	2	5	10	25	50	100
24-Hr Rainfall (in)	2.6	3.2	4.2	5.1	5.6	6.3	7.2
Ia/P Ratio	0.22	0.18	0.13	0.11	0.10	0.09	0.08
Used	0.22	0.18	0.13	0.11	0.10	0.10	0.10
Runoff (in)	0.85	1.27	2.05	2.80	3.23	3.85	4.66
Unit Peak Discharge	1.511	1.534	1.558	1.572	1.578	1.578	1.578
(cfs/acre/in)							
Pond and Swamp Factor	1.00	1.00	1.00	1.00	1.00	1.00	1.00
0.0% Ponds Used							
-----	-----	-----	-----	-----	-----	-----	-----
Peak Discharge (cfs)	1	2	2	3	4	5	6
=====							
* - Value(s) provided from TR-55 system routines							



Appendix C.2. Design Example 2 – Water Quality BMPs

**Figure C.2.3** Comstock Commercial Center – Drainage Area (DA) 1  
(source: TR-55 computer printouts)

RUNOFF CURVE NUMBER COMPUTATION		Version 2.10					
Project : COMSTOCK COMMERCIAL	User: SRC	Date: 09-27-1999					
County : HOWARD	State: MD	Checked: _____	Date: _____				
Subtitle: DRAINAGE AREA DA-1							
COVER DESCRIPTION		A	B	C	D		
		Hydrologic Soil Group					
		Acres (CN)					
-----							
FULLY DEVELOPED URBAN AREAS (Veg Estab.)							
Open space (Lawns,parks etc.)							
Good condition; grass cover > 75%		-	.04 (61)	-	-		
Impervious Areas							
Paved parking lots, roofs, driveways		-	0.16(98)	-	-		
Total Area (by Hydrologic Soil Group)			.20				
			====				
-----							
TOTAL DRAINAGE AREA: .20 Acres		WEIGHTED CURVE NUMBER: 91*					
-----							
* - Generated for use by GRAPHIC method							
GRAPHICAL PEAK DISCHARGE METHOD		Version 2.10					
Project : COMSTOCK COMMERCIAL CENTER		User: SRC		Date: 12-07-1999			
County : HOWARD		State: MD		Checked: _____			
Date: _____							
Subtitle: DEVELOPED CONDITIONS DA-1							
Data: Drainage Area : .2 Acres							
Runoff Curve Number : 91							
Time of Concentration: 0.10 Hours							
Rainfall Type : II							
Pond and Swamp Area : NONE							
=====							
Storm Number	1	2	3	4	5	6	7
Frequency (yrs)	1	2	5	10	25	50	100
24-Hr Rainfall (in)	2.6	3.2	4.2	5.1	5.6	6.3	7.2
Ia/P Ratio	0.08	0.06	0.05	0.04	0.04	0.03	0.03
Used	0.10	0.10	0.10	0.10	0.10	0.10	0.10
Runoff (in)	1.70	2.26	3.21	4.08	4.57	5.25	6.14
Unit Peak Discharge (cfs/acre/in)	1.578	1.578	1.578	1.578	1.578	1.578	1.578
Pond and Swamp Factor	1.00	1.00	1.00	1.00	1.00	1.00	1.00
0.0% Ponds Used							
Peak Discharge (cfs)	1	1	1	1	1	2	2
=====							

Appendix C.2. Design Example 2 – Water Quality BMPs

**Figure C.2.4** Comstock Commercial Center – Drainage Area (DA) 2  
(source: TR-55 computer printouts)

RUNOFF CURVE NUMBER COMPUTATION				Version 2.10			
Project :	COMSTOCK COMMERCIAL CENTER	User:	SRC	Date:	09-21-1999		
County :	HOWARD	State:	MD	Checked:	_____	Date:	_____
Subtitle:	DRAINAGE AREA DA-2 DEVELOPED						
-----							
COVER DESCRIPTION	Hydrologic Soil Group						
	A	B	C	D			
-----							
FULLY DEVELOPED URBAN AREAS (Veg Estab.)							
Open space (Lawns,parks etc.)							
Good condition; grass cover > 75%	-	0.02(61)	-	-			
Impervious Areas							
Paved parking lots, roofs, driveways	-	0.20(98)	-	-			
Total Area (by Hydrologic Soil Group)		.22					
		====					
-----							
TOTAL DRAINAGE AREA: .22 Acres				WEIGHTED CURVE NUMBER: 95*			
-----							
* - Generated for use by GRAPHIC method							
GRAPHICAL PEAK DISCHARGE METHOD				Version 2.10			
Data: Drainage Area	:	.22 *	Acres				
Runoff Curve Number	:	95 *					
Time of Concentration:	0.10	Hours	(MINIMUM VALUE)				
Rainfall Type	:	II					
Pond and Swamp Area	:	NONE					
=====							
Storm Number	1	2	3	4	5	6	7
Frequency (yrs)	1	2	5	10	25	50	100
24-Hr Rainfall (in)	2.6	3.2	4.2	5.1	5.6	6.3	7.2
Ia/P Ratio	0.04	0.03	0.03	0.02	0.02	0.02	0.01
Used	0.10	0.10	0.10	0.10	0.10	0.10	0.10
Runoff (in)	2.06	2.64	3.63	4.52	5.01	5.71	6.60
Unit Peak Discharge (cfs/acre/in)	1.578	1.578	1.578	1.578	1.578	1.578	1.578
Pond and Swamp Factor	1.00	1.00	1.00	1.00	1.00	1.00	1.00
0.0% Ponds Used							
Peak Discharge (cfs)	1	1	1	2	2	2	2
=====							
* - Value(s) provided from TR-55 system routines							

Step 2. Compute  $Re_v$

Step 2a. Determine Soil Specific Recharge Factor ( $S$ ) Based on Hydrologic Soil Group

Soils found throughout the site are loams (HSG B) therefore  $S = 0.26$

Step 2b. Compute  $Re_v$  Using Percent Volume Method

$$\begin{aligned} Re_v &= [(S)(R_v)(A)]!12 \\ &= [(0.26)(0.471)(0.77)]!12 \\ &= \underline{0.0078 \text{ ac-ft.}} \text{ (342.3 cf)} \end{aligned}$$

Step 2c. Compute  $Re_v$  Using Percent Area Method

$$\begin{aligned} Re_v &= (S)(A_i) \\ &= (0.26)(0.36 \text{ ac.}) \\ &= 0.094 \text{ acres (4,095 sf.)} \end{aligned}$$

The  $Re_v$  requirement may be met by: a) treating 342.3 cubic feet using structural methods, b) treating 4,095 square feet using non-structural methods, or c) a combination of both.

Step 3. Compute  $Cp_v$

The proposed community center is located within a USE I watershed, therefore use an extended detention time ( $T$ ) of 24 hours for the one-year storm event. The time of concentration ( $t_c$ ) and one-year runoff ( $Q_a$ ) are 0.10 hours and 0.85” respectively.

Use the MDE Method to Compute Storage Volume (Appendix D.11):

Initial abstraction ( $I_a$ ) for CN of 78 is 0.564: (TR-55) [ $I_a = (200/CN)-2$ ]

$$\begin{aligned} I_a/P &= (0.564)!2.6'' = 0.22 \\ t_c &= 0.10 \text{ hours} \end{aligned}$$

$q_u = 975 \text{ csm/in.}$  (Figure D.11.1, Appendix D.11)

$$\begin{aligned} q_i &= q_u A Q_a \quad \text{where } A \text{ is the drainage area in square miles} \\ &= (975 \text{ csm})(0.0012 \text{ square miles})(0.85'') \\ &= 1.0 \text{ cfs; } q_i < 2.0 \text{ cfs } \therefore Cp_v \text{ is not required.} \end{aligned}$$

Step 4. Compute Requirements for Sub-Drainage Areas DA-1, DA-2 and DA-3

DA-1:  $R_v = 0.05 + (0.009)(I); I = 0.16 \text{ acres} / 0.20 \text{ acres} = 0.80 \text{ or } 80\%$   
 $= 0.05 + (0.009)(80.0) = 0.77$

$$\begin{aligned} WQ_v &= [(P)(R_v)(A)]/12 \\ &= [(1'')(0.77)(0.20 \text{ ac})]/12 \\ &= \underline{0.0128 \text{ ac-ft}} \text{ (557.5 cf.)} \end{aligned}$$

$$\begin{aligned} Re_v &= [(S)(R_v)(A)]/12 \\ &= [(0.26)(0.77)(0.20 \text{ ac})]/12 \\ &= \underline{0.0033 \text{ ac-ft}} \text{ (145 cf.)} \end{aligned}$$

DA-2:  $R_v = 0.05 + (0.009)(I); I = 0.20 \text{ acres} / 0.22 \text{ acres} = 0.91 \text{ or } 91\%$   
 $= 0.05 + (0.009)(91) = 0.87$

$$\begin{aligned} WQ_v &= [(P)(R_v)(A)]/12 \\ &= [(1'')(0.87)(0.22 \text{ ac.})]/12 \\ &= \underline{0.0160 \text{ ac-ft}} \text{ (694.8 cf.)} \end{aligned}$$

$$\begin{aligned} Re_v &= [(S)(R_v)(A)]/12 \\ &= [(0.26)(0.87)(0.22 \text{ ac.})]/12 \\ &= \underline{0.0041 \text{ ac-ft}} \text{ (180.6 cf.)} \end{aligned}$$

DA-3:  $R_v = 0.05 + (0.009)(I); I = 0.0 \text{ acres} / 0.35 \text{ acres} = 0.0 \text{ or } 0\%$   
 $= 0.05 + (0.009)(0.0) = 0.05$

Because  $I < 15\%$ ,  $WQ_v = 0.2''/\text{acre}$

$$\begin{aligned} WQ_v &= [(0.2'')(0.35 \text{ ac.})]/12 \\ &= \underline{0.0058 \text{ ac-ft}} \text{ (254.1 cf.)} \end{aligned}$$

$$\begin{aligned} Re_v &= [(S)(R_v)(A)]/12 \\ &= [(0.26)(0.05)(0.35 \text{ ac.})]/12 \\ &= \underline{0.0004 \text{ ac-ft}} \text{ (16.5 cf.)} \end{aligned}$$

NOTE: Although DA-3 has no proposed impervious surfaces, portions of DA-3 will be disturbed to construct structural BMPs for DA-1 and DA-2. As a result,  $WQ_v$  and  $Re_v$  must be addressed for DA-3. For this example, the portion of DA-3 not disturbed for BMP construction shall be treated by promoting sheet flow into the adjacent forested buffer (see Chapter 5.4, "Sheetflow to Buffer Credit").

**Table C.2.1** Summary of General Storage Requirements for Comstock Commercial Center

Requirement	Drainage Area	Volume Required (cubic feet)	Notes
WQ <sub>v</sub> *	Total	1,316.5	The sum of treatment volumes for DA-1, DA-2 and DA-3 is greater than that calculated for the entire site.
	DA-1	557.5	
	DA-2	694.8	
	DA-3	254.1	
Re <sub>v</sub> *	Total	342.3 (or 4,095 sf.)	volume is included within the WQ <sub>v</sub> storage
	DA-1	145.6 (or 1,812 sf.)	
	DA-2	180.6 (or 2,265 sf.)	
	DA-3	16.1	
Cp <sub>v</sub>		N/A	Cp <sub>v</sub> inflow rate is < 2.0 cfs
Q <sub>p10</sub>		N/A	not required
Q <sub>f</sub>		N/A	provide safe passage for the 100-year event in final design

### C.2.3 BMP Design Option 1

The first option consists of the design of a perimeter sand filter (F-3) for DA-1 and a pocket sand filter (F-5) for DA-2. In both designs,  $Re_v$  storage will be provided below the filter's underdrain system. As a result, the entire  $WQ_v$  must be considered in the design of each filter system. A plan view for Option 1 is shown in Figure C.2.5

#### C.2.3.1 Perimeter Sand Filter (F-3) for DA-1

##### Pretreatment

The pretreatment requirements for a perimeter sand filter are as follows:

The pretreatment volume ( $V_p$ ) for the perimeter sand filter shall be at least 25% of the computed  $WQ_v$ :

$$\begin{aligned} V_p &= (0.25)(WQ_v) \\ &= (0.25)(557.5 \text{ cf.}) \\ &= 139.4 \text{ cf.} \end{aligned}$$

The minimum required surface area as computed by the Camp-Hazen equation:

$$A_s = \frac{Q_o}{W} \times E' \quad (\text{see Section 3.4.3 for terms})$$

For imperviousness ( $I$ ) > 75%, this equation reduces to:

$$\begin{aligned} A_{sp} &= (0.0081)(WQ_v) \\ &= (0.0081)(557.5 \text{ cf.}) \\ &= 4.52 \text{ sf.} \end{aligned}$$

Using a width ( $w$ ) = 1.5 ft. and length ( $l$ ) = 45 ft., the required depth for the sedimentation chamber = 139.4 cf. / (1.5 ft.)(45 ft.) = 2.06 ft.; **Use a sedimentation chamber 1.5 ft. by 45 ft. by 2.1 ft.**

Figure C.2.5 Design Option 1 - Plan View

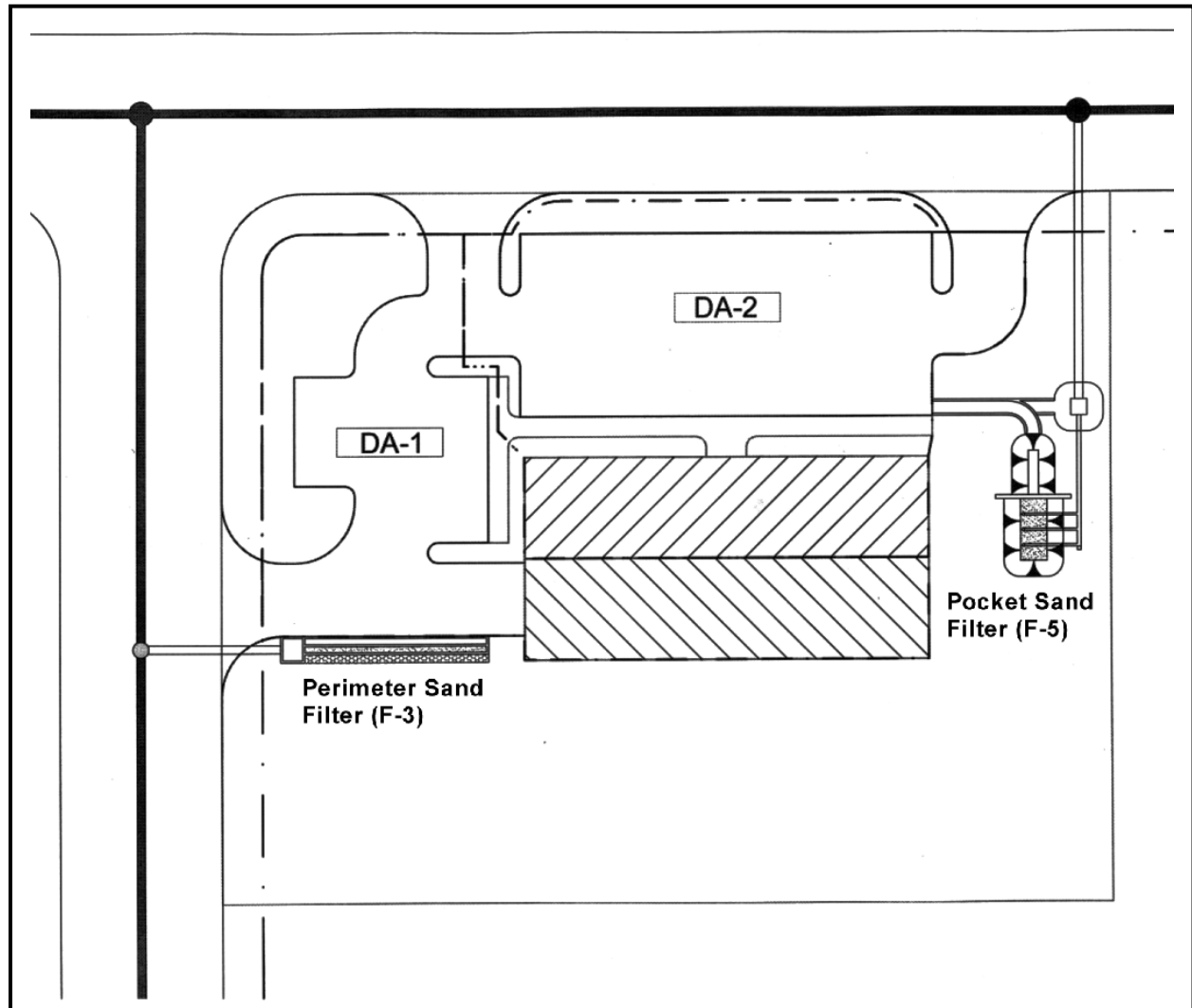

### Treatment

The treatment requirements for the perimeter sand filter are as follows:

The entire treatment system (including pretreatment) shall temporarily hold at least 75% of the  $WQ_v$  prior to filtration:

$$\begin{aligned} V_{temp} &= (0.75)(WQ_v) \\ &= (0.75)(557.5 \text{ cf.}) \\ &= 418.1 \text{ cf.} \end{aligned}$$

The required filter bed area ( $A_f$ ) is computed using the following equation:

$$A_f = \frac{(WQ_v)(d_f)}{[k \times (h_f + d_f) \times t_f]} \quad (\text{see Section 3.4.4})$$

## Appendix C.2. Design Example 2 – Water Quality BMPs

---

Minimum filter bed depth ( $d_f$ ) = 12"; for this design use  $d_f = 12"$  (1.0 ft)

The coefficient of permeability ( $k$ ) for sand filters = 3.5 ft./day

The average height of water above the filter bed ( $h_f$ ) = (0.5)(design ponding depth). For this design, the ponding depth = 1.0 ft.  $\therefore h_f = 0.5$  ft.

The design filter bed drain time ( $t_f$ ) = 1.67 days

$$\text{Therefore: } A_f = \frac{(557.5 \text{ cf.})(1.0 \text{ ft.})}{[(3.5 \text{ ft./day})(0.5 \text{ ft.} + 1.0 \text{ ft.})(1.67 \text{ days})]} = 63.6 \text{ sf.}$$

Setting the filter chamber width ( $w$ ) to 1.5 ft., the length ( $l$ ) of the filter chamber = 63.6 sf./1.5 ft. = 42.4 ft; **Use a filter chamber 1.5 ft. by 45 ft.**

$$\begin{aligned} \text{Check } V_{temp}: \quad V_{temp} &= V_p + V_{treatment} \\ &= 139.4 + [(1.0)(1.5)(45) + (1.0)(1.5)(45)(0.4)] = 236.5 \text{ cf.} \\ &\text{note: 0.4 is the porosity of the filter media} \end{aligned}$$

Approximately 182 cf. of additional storage is needed to meet this requirement. Either increase the storage in one or both chambers or design parking area to provide additional storage. For this design, the pretreatment chamber width will be increased to 3.5 ft.

$$\begin{aligned} V_{temp} &= V_p + V_{treatment} \\ &= (3.5)(45.0)(2.1) + [(1.0)(1.5)(45) + (1.0)(1.5)(45)(0.4)] = 425.25 \text{ cf.} \end{aligned}$$

### Groundwater Recharge ( $Re_v$ )

$Re_v$  storage will be provided within a stone-filled trench adjacent to the perimeter sand filter. Setting the trench length ( $l$ ) = 45 ft., and the width ( $w$ ) = 2.0 ft, the trench depth ( $d$ ) needed to store the  $Re_v$  volume ( $V = 145.6$  cf.) is:

$$\text{where } d = \frac{V}{l \times w \times n} \quad n \text{ is the porosity of stone; use } n = 0.4$$

Therefore,  $d = 145.6 \text{ cf.}/(45.0 \text{ ft.} \times 2.0 \text{ ft.} \times 0.4) = 4.04 \text{ ft.};$  **use a stone-filled trench 45.0 ft. by 2.0 ft. by 4.1 ft.**

### Overflow

Flow splitters and overflow devices may be designed using volume or flow rate. For this example, a weir discharging from the sedimentation chamber into the clear well will provide volume overflow for the ten-year storm. For DA-1, the ten-year flow ( $Q_{10}$ ) = 1.0 cfs. Using a weir length of 1.5 ft., the head required to safely convey  $Q_{10}$  may be calculated using the weir equation:  $Q = Clh^{3/2}$  where  $C = 3.1$ ,  $l$  = weir length (1.5 ft.), and



$h$  = head. By rearranging the weir equation and solving for  $h$ ;  $h=[Q/(C3l)]^{2/3} = 0.40$  ft.  
**Design perimeter sand filter with at least 0.4 ft. freeboard to safely convey  $Q_{10}$ .**

Design details for the perimeter sand filter are shown in Figures C.2.6.

### C.2.3.2 Pocket Sand Filter (F-5) for DA-2

#### **Pretreatment**

The pretreatment requirements for a pocket sand filter are as follows:

$V_p$  for the pocket sand filter shall be at least 25% of the computed  $WQ_v$ :

$$\begin{aligned}V_p &= (0.25)(WQ_v) \\ &= (0.25)(694.8 \text{ cf.}) \\ &= 173.7 \text{ cf.}\end{aligned}$$

The minimum required surface area as computed by the Camp-Hazen equation:

$$A_s = \frac{Q_o}{W} \times E'$$

For  $I > 75\%$ , this equation reduces to:

$$\begin{aligned}A_{sp} &= (0.0081)(WQ_v) \\ &= (0.0081)(694.8 \text{ cf.}) \\ &= 5.62 \text{ sf.}\end{aligned}$$

Maintaining at least a 2:1 ratio ( $l:w$ ); set  $w = 6.5$  ft. and  $l = 13.0$  ft. The required  $d$  for the sedimentation area =  $173.7 \text{ cf.} / (6.5 \text{ ft.})(13.0 \text{ ft.}) = 2.0$  ft.; **Use a sedimentation chamber 6.5 ft. by 13.0 ft. by 2.0 ft.**

Figure C.2.6 Perimeter Sand Filter Design Details

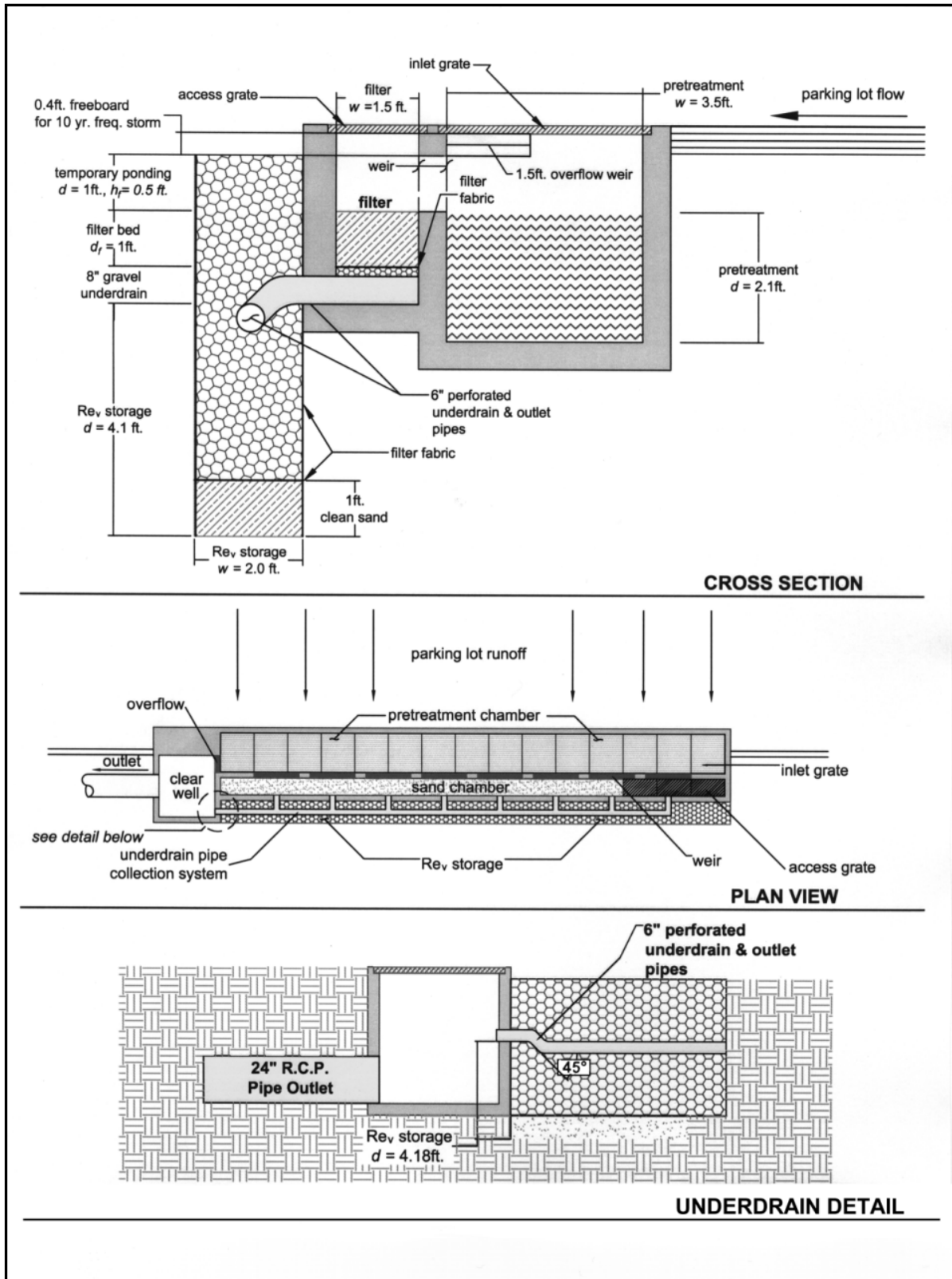

## Treatment

The treatment requirements for the pocket sand filter are as follows:

The entire treatment system (including pretreatment) shall temporarily hold at least 75% of the WQv prior to filtration:

$$\begin{aligned} V_{temp} &= (0.75)(WQ_v) \\ &= (0.75)(694.8 \text{ cf.}) \\ &= 521.1 \text{ cf.} \end{aligned}$$

The required filter bed area is computed using the following equation:

The minimum  $d_f$  for a pocket sand filter = 18"; for this design use  $d_f = 18''$  (1.5').

$$A_f = \frac{(WQ_v)(d_f)}{[k \times (h_f + d_f) \times t_f]}$$

The coefficient of permeability ( $k$ ) for sand filters = 3.5 ft/day

The average height of water ( $h_f$ ) above the filter bed for this design = 0.5 ft.

The design filter bed drain time ( $t_f$ ) = 1.67 days.

$$\text{Therefore: } A_f = \frac{(694.8 \text{ cf.})(1.5 \text{ ft.})}{[(3.5 \text{ ft./day})(0.5 \text{ ft.} + 1.5 \text{ ft.})(1.67 \text{ days})]} = 89.2 \text{ sf.}$$

Setting the filter chamber width ( $w$ ) to 6.5 ft.  $l = 89.2 \text{ ft.} / 6.5 \text{ ft.} = 13.7 \text{ ft.}$ ; **Use a filter chamber 6.5 ft. by 13.7 ft.**

$$\begin{aligned} \text{Check } V_{temp}: \quad V_{temp} &= V_p + V_{treatment} \\ &= 173.7 + [(1.0)(6.5)(13.7) + (1.5)(6.5)(13.7)(0.4)] = 316.1 \text{ cf.} \\ &\text{note: 0.4 is the porosity of the filter media} \end{aligned}$$

Approximately 205 cf. of additional storage is needed to meet this requirement. Either increase the storage in one or both chambers or design parking area to provide additional storage. For this design, the pretreatment chamber width will be increased to 9.0 ft. and the depth increased to 3.0 ft.

$$\begin{aligned} V_{temp} &= V_p + V_{treatment} \\ &= (9.0)(13.0)(3.0) + [(1.5)(6.5)(13.7) + (1.5)(6.5)(13.7)(0.4)] = 538.0 \text{ cf} \end{aligned}$$

### Groundwater Recharge ( $Re_v$ )

$Re_v$  storage will be provided within a stone-filled reservoir directly below the filter chamber's underdrain system. Using  $w = 6.5$  ft. and  $l = 13.7$  ft., the depth needed to store the  $Re_v$  volume ( $V = 180.6$  cf.) is:

$$d = \frac{V}{l \times w \times n} \quad \text{where } n \text{ is the porosity of stone; use } n = 0.4$$

Therefore,  $d = 180.6 / (13.7 \text{ ft.} \times 6.5 \text{ ft.} \times 0.4) = 5.1$  ft.; **Use a stone-filled reservoir 6.5 ft. by 13.7 ft. by 5.1 ft.**

### Overflow/Bypass

As the pocket sand filter will be located “off-line” from the main conveyance system, a flow splitter will be required to divert the  $WQ_v$  into the filter. Flow splitters may be designed using volume or flow rate. For this example, use a concrete flume with a bottom width of 4.0 ft designed to divert the flow associated with the  $WQ_v$ . The head required to divert the  $WQ_v$  flow may be calculated using the weir equation:  $Q = Clh^{3/2}$  where  $Q$  is flow associated with  $WQ_v$  (using Appendix D.10,  $Q = 0.3$  cfs),  $C = 3.1$ ,  $l = 4.0$  ft., and  $h$  = head. By rearranging the equation and solving for  $h$ ;  $h = [Q / (Cl)]^{2/3} = 0.084$  ft. **Design flow splitter with a 1 inch high diversion.** NOTE: With this type of flow splitter, runoff in excess of the  $WQ_v$  may continue to flow into the sand filter.

Design details for the pocket sand filter are shown in Figures C.2.7 and C.2.8.

Figure C.2.7 Pocket Sand Filter – Plan View

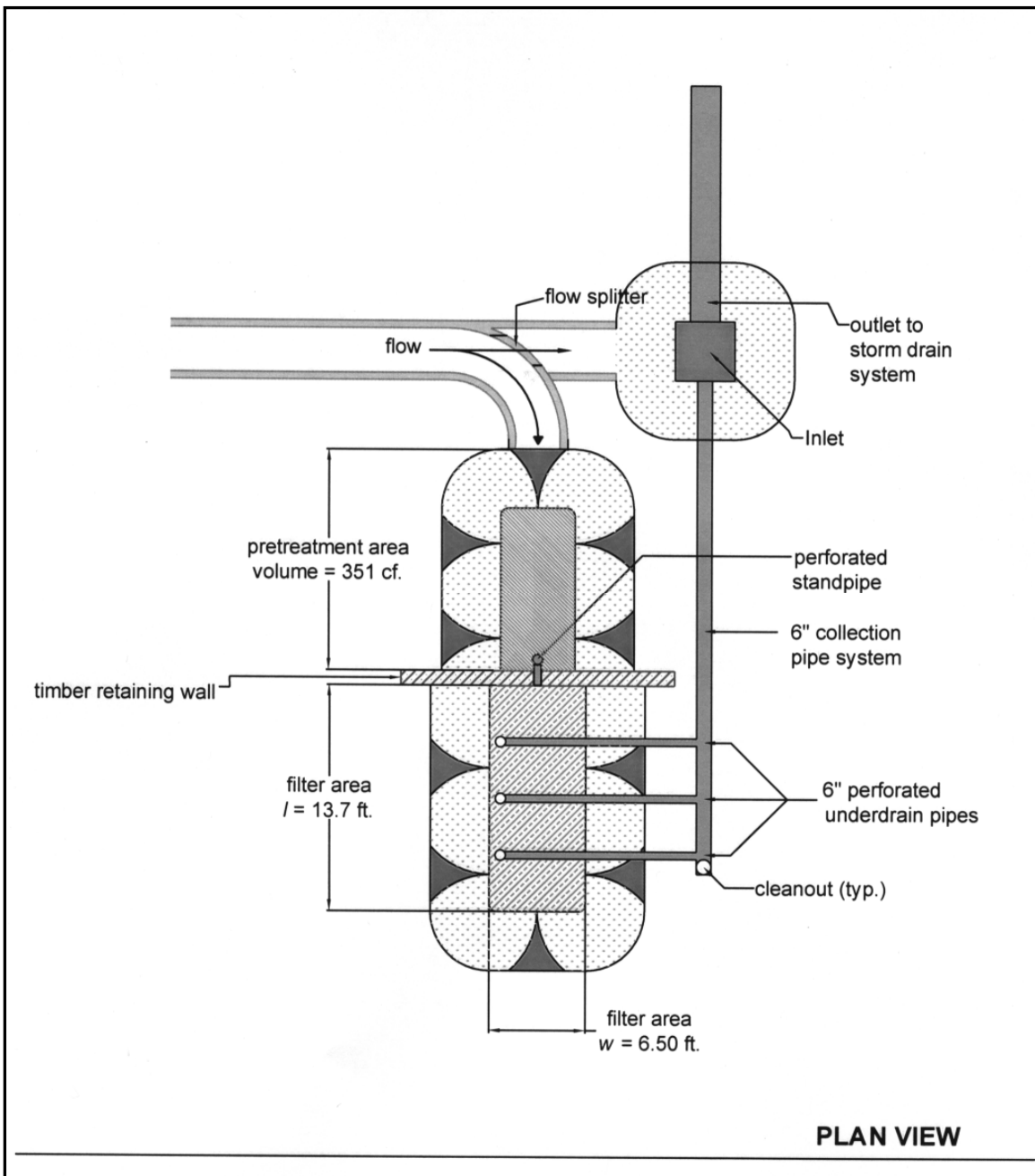
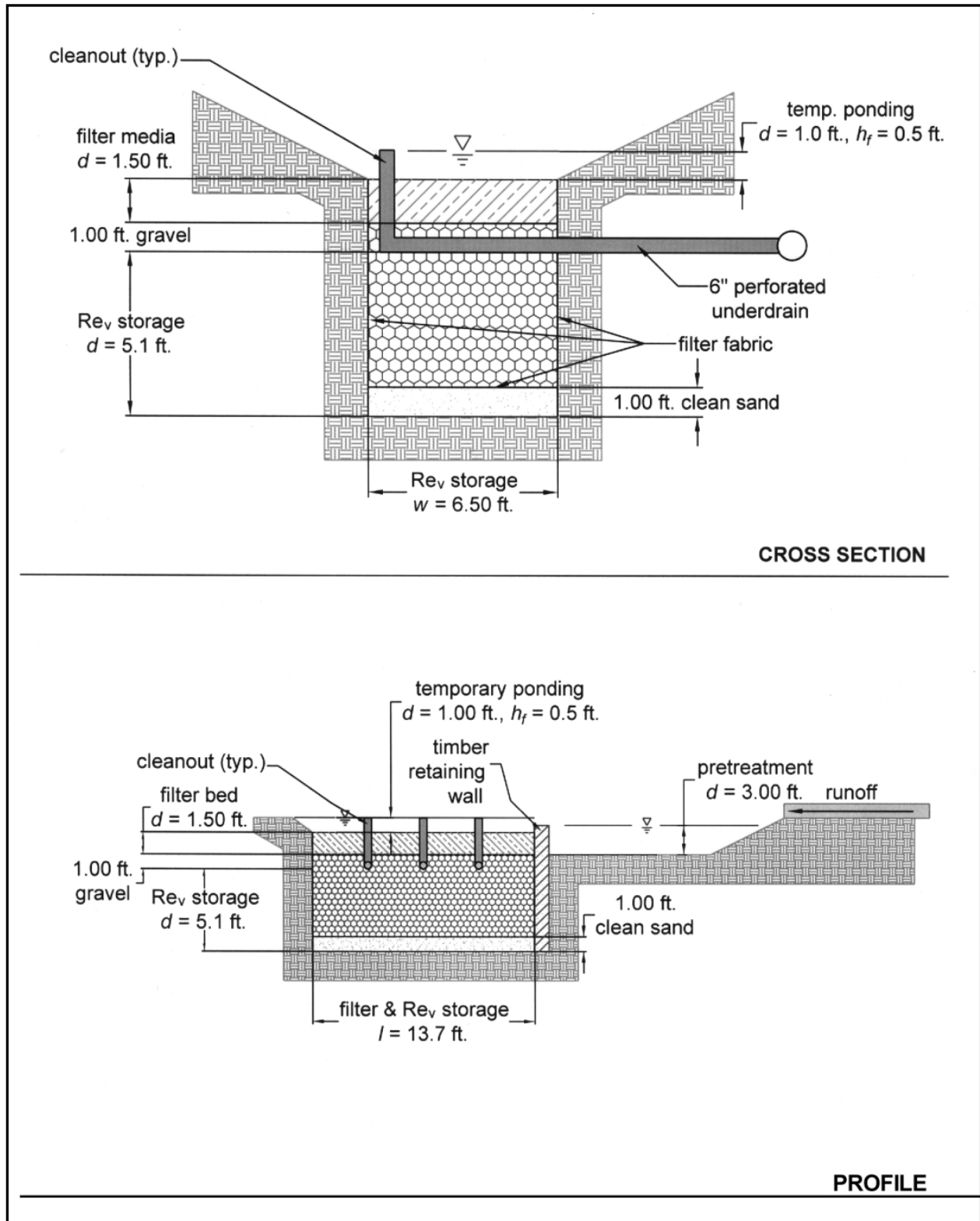

Figure C.2.8 Pocket Sand Filter Design Details



**C.2.4 BMP Design Option 2.**

The second option consists of the design of a bioretention area (F-6) for DA-1 and an infiltration trench (I-1) for DA-2. For the bioretention system,  $Re_v$  storage will be provided below the underdrain system, and as a result, the entire  $WQ_v$  will be used as the design. The infiltration trench automatically meets the  $Re_v$  requirement. A plan view of Option 2 is shown in Figure C.2.9.

Figure C.2.9 Design Option 2 – Plan View

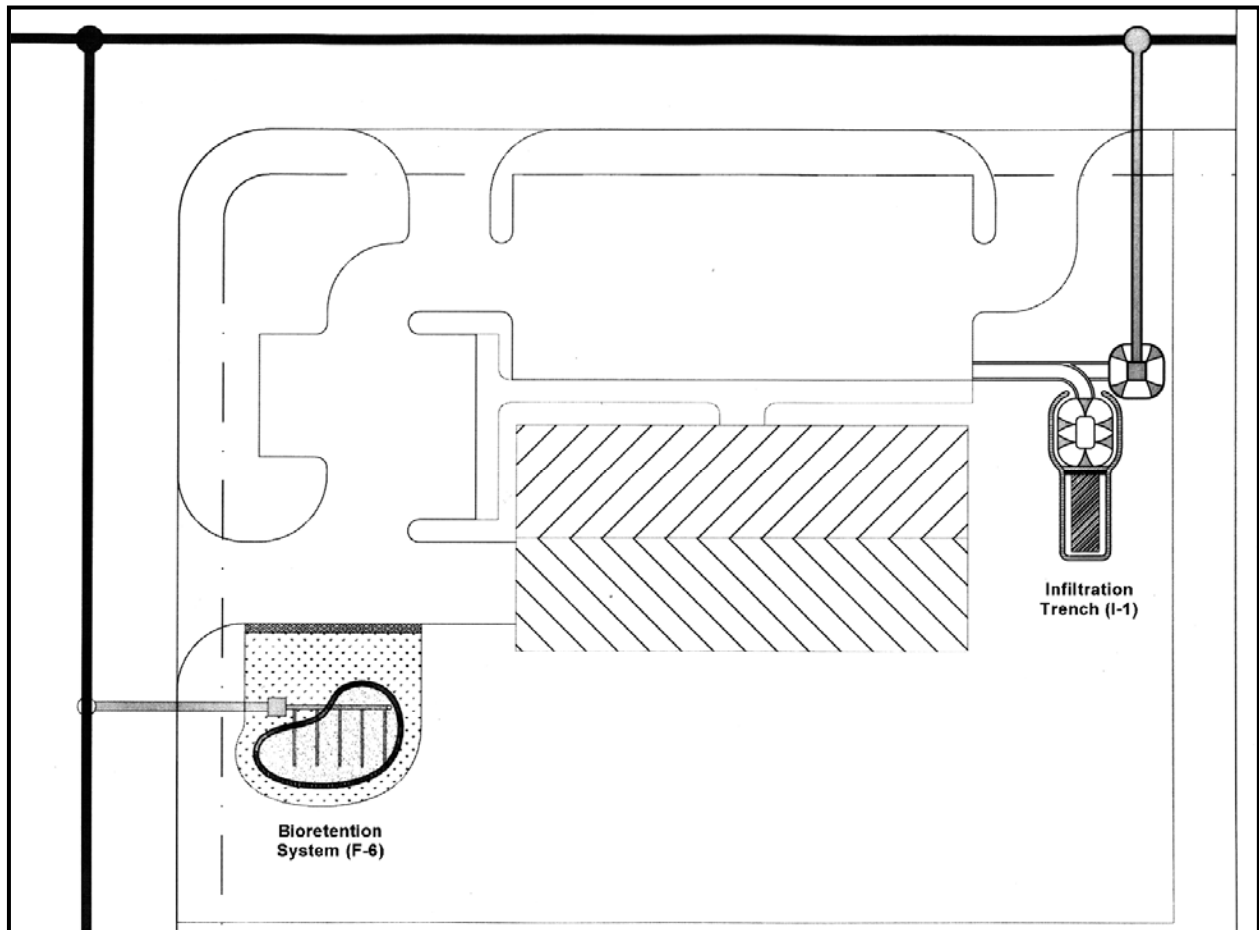

C.2.4.1 Bioretention System (F-6) for DA-1

**Pretreatment**

Adequate pretreatment for a bioretention system is provided when all of the following are provided:

1. 20 ft. grass filter strip below a level spreader or an optional sand filter layer;
2. gravel diaphragm; and
3. 2” to 3” mulch layer.

**Treatment**

The treatment requirements for the bioretention system are as follows (Section 3.4.3 & 4):

The entire treatment system (including pretreatment) shall temporarily hold at least 75% of the WQ<sub>v</sub> prior to filtration:

$$\begin{aligned} V_{temp} &= (0.75)(WQ_v) \\ &= (0.75)(557.5 \text{ cf.}) \\ &= 418.1 \text{ cf.} \end{aligned}$$

The required filter bed area ( $A_f$ ) is computed using the following equation:

$$A_f = \frac{(WQ_v)(d_f)}{[k \times (h_f + d_f) \times t_f]}$$

Recommended filter bed depth ( $d_f$ ) for a bioretention system is 2.5 to 4.0 ft. For this design, use  $d_f = 3.0$  ft.

The coefficient of permeability ( $k$ ) for bioretention systems = 0.5 ft./day

The average height of water above the filter bed ( $h_f$ ) = 0.5 ft. (Note: The maximum ponding depth for a bioretention system is 1.0 ft.)

The design filter bed drain time ( $t_f$ ) = 2.0 days

$$\text{Therefore: } A_f = \frac{(557.5 \text{ cf.})(3.0 \text{ ft.})}{[(0.5 \text{ ft./day})(0.5 \text{ ft.} + 3.0 \text{ ft.})(2.00 \text{ days})]} = 477.9 \text{ sf.}$$

**Use a bioretention system with minimum surface area =478 sf.**

$$\text{Check } V_{temp}: \quad V_{temp} = V_{treatment} = (1.0)(478 \text{ sf}) + (3.0)(478 \text{ sf})(0.4) = 1051.6 \text{ cf.}$$

note: 0.4 is the porosity of the filter media



### Groundwater Recharge ( $Re_v$ )

$Re_v$  storage will be provided in a stone-filled reservoir directly below the underdrain system. Setting the reservoir area ( $A_r$ ) = 478 sf., the depth ( $d$ ) needed to store the  $Re_v$  volume ( $V=145.6$  cf.) is:

$$d = \frac{V}{A_r \times n} \quad \text{where } n \text{ is the porosity of stone; use } n = 0.4$$

Therefore;  $d = 145.6 \text{ cf.} / (478.0 \text{ ft.} \times 0.4) = 0.76 \text{ ft.}$ ; **Use a stone-filled reservoir 478 sf. by 0.76 ft.**

### Overflow

Overflow for the ten-year storm shall be provided to a non-erosive outlet. For this design, a standard inlet will be used to bypass the volume in excess of the  $WQ_v$  by setting the inlet invert at the elevation corresponding to the  $WQ_v$  treatment volume (1.0 ft. above the bioretention system filter bed).

Design details and a planting plan for the bioretention system are shown in Figures C.2.10 and C.2.11.

Appendix C.2. Design Example 2 – Water Quality BMPs

Figure C.2.10 Bioretention System Details

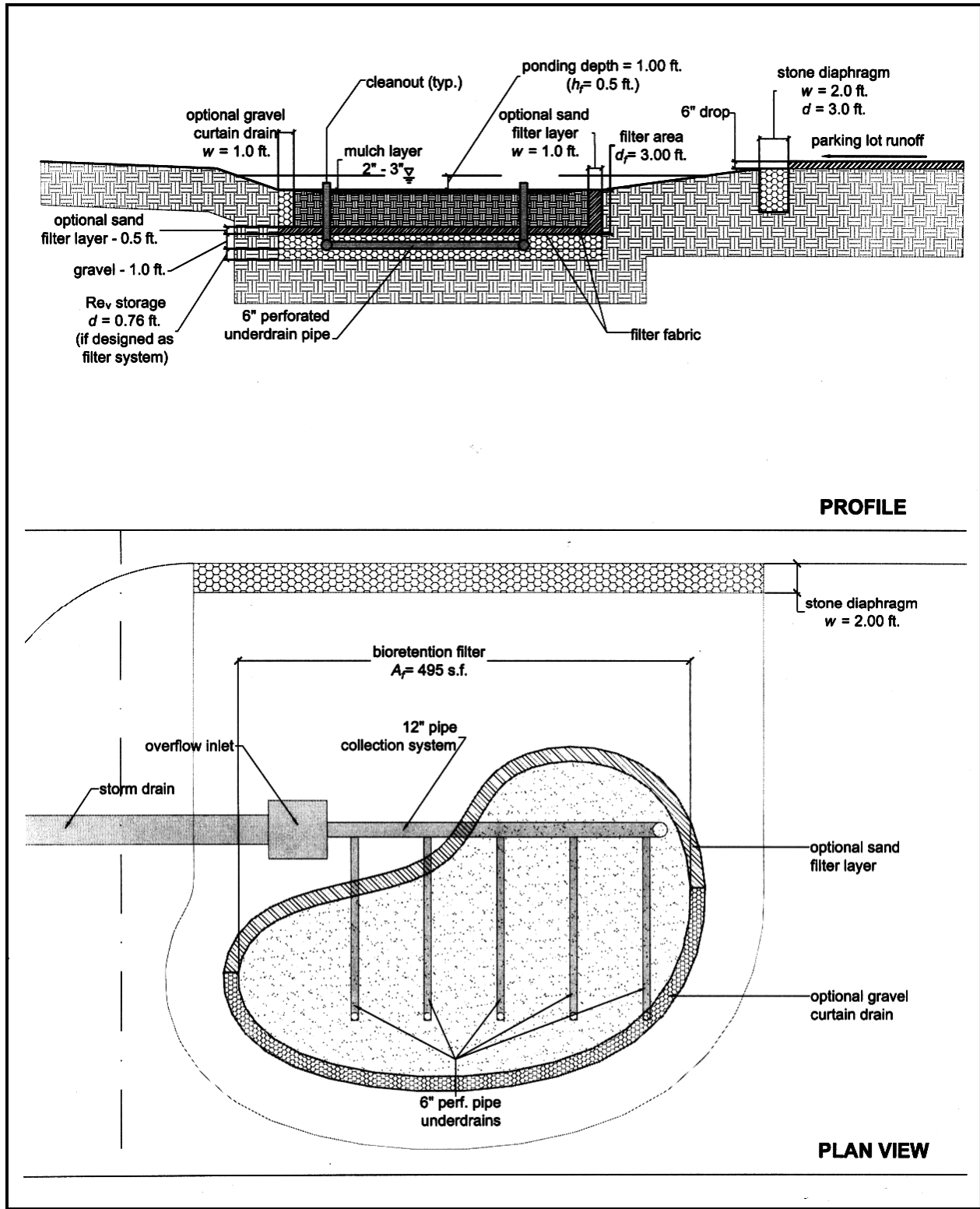
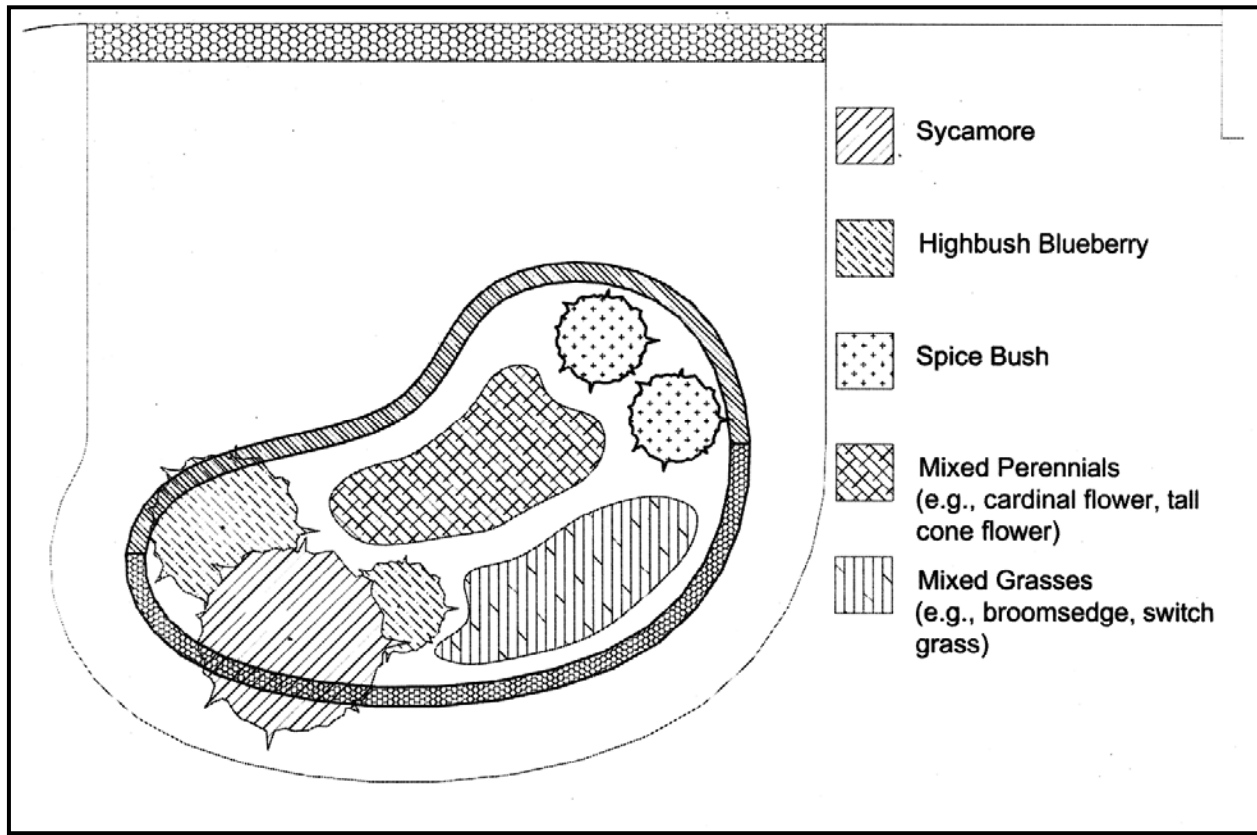

Figure C.2.11 Bioretention Planting Plan



C.2.4.2 Infiltration Trench (I-1) for DA-2

**Pretreatment**

The pretreatment requirements for an infiltration trench are as follows:

The pretreatment volume ( $V_p$ ) for the infiltration trench shall be at least 25% of the computed  $WQ_v$ :

$$\begin{aligned} V_p &= (0.25)(WQ_v) \\ &= (0.25)(694.8 \text{ cf.}) \\ &= 173.7 \text{ cf.} \end{aligned}$$

Using a width ( $w$ ) of 8.0 ft. and a length ( $l$ ) of 11.0 ft., the required depth for the sedimentation chamber =  $173.7 \text{ cf.} / (8.0 \text{ ft.})(11.0 \text{ ft.}) = 1.97 \text{ ft.}$ ; **Use a sedimentation chamber 8.0 ft by 11.0 ft. by 2.0 ft.**

Additionally, each infiltration trench shall have at least three of the following measures to prevent clogging and maintain the long-term integrity of the trench:

1. grass channel;
2. grass filter strip (minimum 20 ft.);
3. bottom sand layer
4. upper sand layer (minimum 6") with filter fabric at sand/gravel interface; and

5. use washed bank run gravel as aggregate.

This design will use a bottom sand layer, upper sand layer, and washed bank run gravel.

### Treatment

The treatment requirements for an infiltration trench are as follows:

The practice shall be designed to exfiltrate the entire WQv less the pretreatment volume through the floor of the practice. The design volume ( $V_w$ ) = WQv -  $V_p$  = 521.1 cf.

Infiltration practices are designed using the methodology in Appendix D.13.

The maximum allowable depth ( $d_{max}$ ) of an infiltration trench is

$$d_{max} = f \times \frac{T_s}{n}$$

where:

- $f$  is the infiltration rate, for this design  $f = 0.52$  inches/hour
- $T_s$  is the maximum allowable storage of 48 hours
- $n$  is the porosity of the stone reservoir, use 0.4

Therefore,  $d_{max} = 0.52$  inches/hour  $\times$  48 hours  $\div$  0.4 = 62.4 inches (5.2 ft). **Use a trench depth ( $d_t$ ) = 5.0 ft.**

Using equation D.13.3, the area of the infiltration trench ( $A_t$ ) is:

$$A_t = \frac{V_w}{nd_t + fT} \quad \text{where the time to fill the trench (T) is 2.0 hours.}$$

**Use an infiltration trench 7.5 ft. by 35.0 ft. by 5.0 ft.**

$$A_t = \frac{521.1 \text{ cf.}}{(0.4 \times 5.0) + (0.52 \text{ inches/hour} \times 2.0 \text{ hours} \times \frac{1 \text{ ft}}{12 \text{ in}})} = 249.7 \text{ sf.}$$

### **Groundwater Recharge ( $Re_v$ )**

Infiltration trenches automatically meet the  $Re_v$  storage requirement; no additional storage is required.

### **Overflow**

As the infiltration trench will be located “off-line” from the main conveyance system, a flow splitter will be required to divert the  $WQ_v$  into the filter. Use the flow splitter design from the pocket sand filter above.

Design details for the infiltration trench are shown in Figures C.2.12.

### **C.2.5 BMP Design Option 3**

The third option consists of the bioretention area (F-6) previously designed for DA-1 and a dry swale (O-1) for DA-2. In the dry swale design,  $Re_v$  storage will be provided below the swale’s underdrain system. As a result, the entire  $WQ_v$  must be considered in the design of the dry swale. A plan view of Option 3 is shown in Figure C.2.13.

#### C.2.5.1 Dry Swale (O-1) for DA-2

### **Pretreatment**

The pretreatment requirements for a dry swale are as follows:

Pretreatment storage of 0.1 inch of runoff from impervious area shall be provided. This is equivalent to 10% of  $WQ_v$ . Therefore,  $V_p = (10\%)(WQ_v) = 69.5$  cf. **Use a forebay or sedimentation chamber sized to store 62.5 cf.**

Figure C.2.12 Infiltration Trench Details

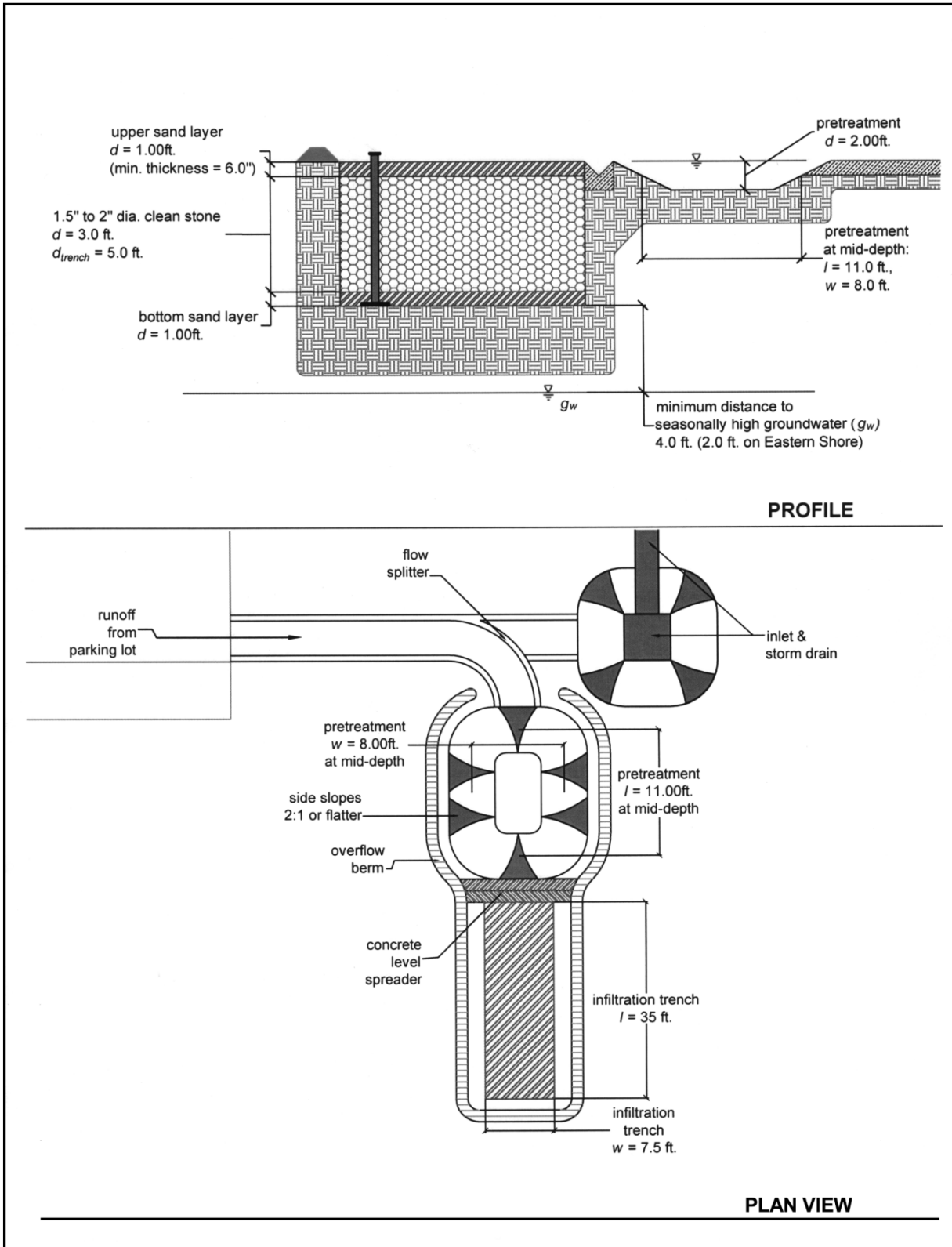
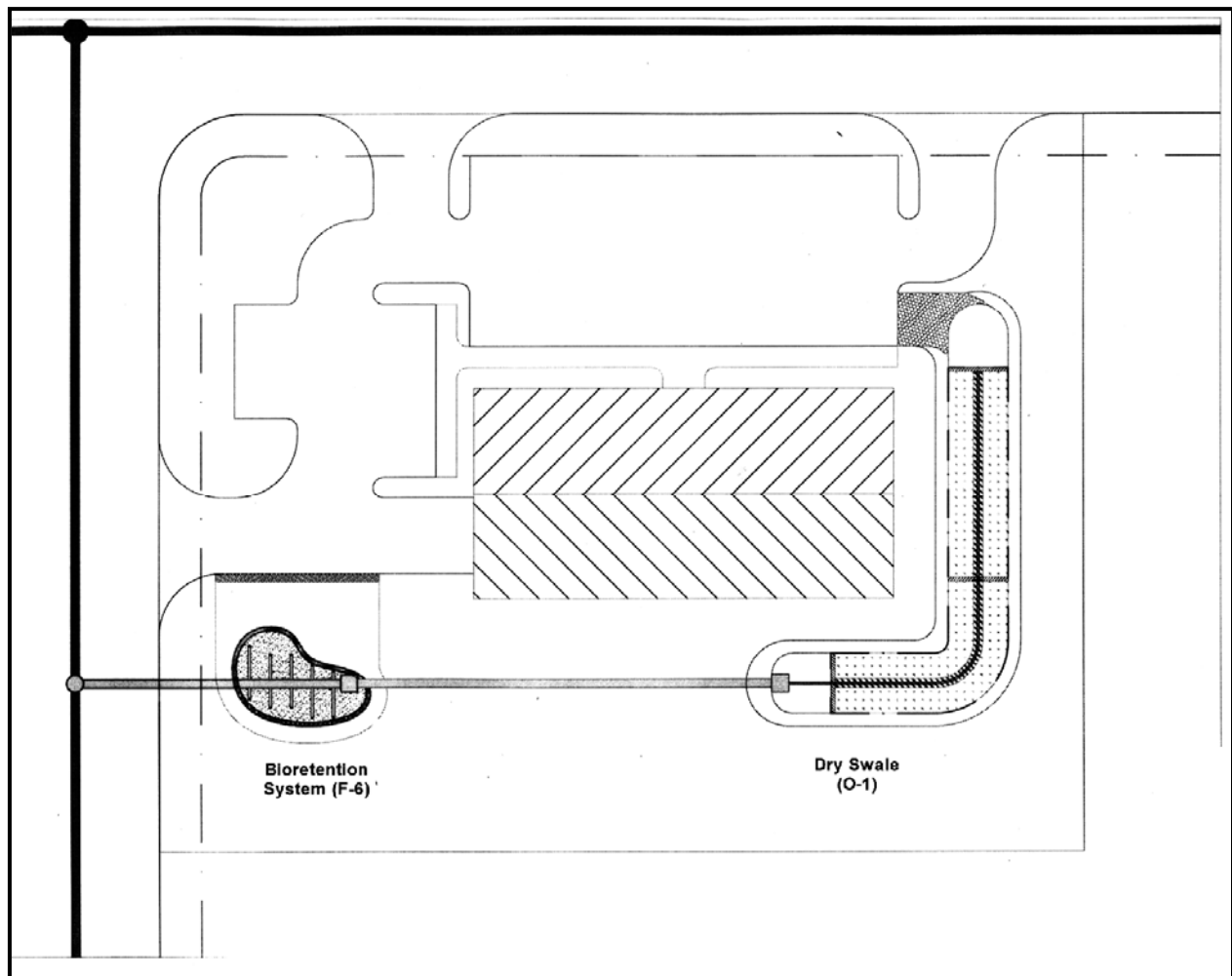

Figure C.2.13 Design Option 3 – Plan View



### Treatment

The treatment requirements for the dry swale are as follows:

Dry swales shall be designed to temporarily store the WQv for a maximum 48-hour period. An underdrain system shall provided to ensure the maximum ponding time is not exceeded.

Dry swales shall have a maximum longitudinal slope ( $s$ ) of 4.0%. **For this design,  $s=3.0\%$ .**

Channel side slopes ( $z:1$ ) should be no steeper than 2:1. **For this design, side slopes shall be 4:1 ( $z=4$ ).**

Dry swales shall have a bottom width ( $w_b$ ) no narrower than 2.0 ft. and no wider than 8.0

## Appendix C.2. Design Example 2 – Water Quality BMPs

---

ft. (if wider than 8.0 ft., a meandering drainage pattern shall be established).

Maximum ponding depths ( $d_{mid}$ ,  $d_{end}$ ) of 1.0 ft. at the channel mid-point and 1.5 ft. at the downstream end shall be maintained. Use  $d_{mid} = 0.75$  ft. and  $d_{max} = 1.5$  ft.

Due to the length (100 ft.) and grade (3.0%) of the channel, the channel will be divided into two contiguous channels separated by a check dam to achieve  $d_{mid}$  and  $d_{end}$  requirements. Use three check dams located at the entrance, mid-point and end of the swale.

With three check dams, there will be two ponding areas of equal storage. Using  $d_{mid}=0.75$  ft., and setting the total length of the swale to 100 ft., the treatment volume of the swale is:

$$WQ_v - V_p = w \times l \times d_{mid}$$

By rearranging this equation and solving for the width of storage surface ( $w$ ):

$$w = \frac{WQ_v - V_p}{l \times d_{mid}} = \frac{694.8 \text{ cf.} - 69.5 \text{ cf.}}{100 \text{ ft.} \times 0.75 \text{ ft.}} = 8.3 \text{ ft.}$$

Using  $w = 8.3$  ft. and 4:1 side slopes,  $w_b = w - (2.3 \times 3 \times d_{mid}) = 8.3 - (2.3 \times 3 \times 0.75) = 2.3$  ft. Use a **dry swale with bottom dimensions of 2.3 ft. by 100 ft. with 4:1 side slopes.**

### Groundwater Recharge ( $Re_v$ )

$Re_v$  storage will be provided within a stone-filled reservoir below the dry swale underdrain system. Using the swale dimensions (2.3 ft by 100 ft.), the reservoir depth ( $d$ ) needed to store the  $Re_v$  volume ( $V=180.6$  cf.) is:

$$d = \frac{V}{l \times w \times n} \quad \text{where } n \text{ is the porosity of stone; use } n=0.4$$

Therefore,  $d = 180.6 \text{ cf.} / (100 \text{ ft.} \times 2.3 \text{ ft.} \times 0.4) = 1.96$  ft. Use a **stone-filled reservoir 2.3 ft. by 100.0 ft. by 2.0 ft.**

### Overflow ( $Q_{10}$ Conveyance)

A dry swale is required to safely convey the 10-year design storm with minimum freeboard of 3 inches. Check the design to ensure that the 10-year storm is conveyed non-erosively and that the minimum freeboard is provided. For DA-2, the 10-year peak flow ( $Q_{10}$ ) = 2.0 cfs. At  $d_{max}$ , the width ( $w_{max}$ ) =  $w + (2.3 \times 3 \times d_{mid}) = 14.3$  ft. Using a trapezoidal channel with a bottom width = 14.3 ft., 4:1 side slopes, and a longitudinal slope ( $s$ ) = 3.0%, the depth ( $d$ ) and velocity ( $v$ ) of flow can be calculated using the Manning equation:

$$v = \frac{1.49}{n} R^{2/3} S^{1/2}$$



where:  $n$  is the roughness coefficient of the channel lining, use 0.025  
 $r$  is the hydraulic radius of the channel; at  $d = 0.10$  ft.,  
 $r$  is very nearly 0.10

Therefore, at  $d=0.1$  ft.:

$$v = \frac{1.49}{0.025} (0.10)^{2/3} (0.03)^{1/2} = 2.2 \text{ fps}$$

The cross-sectional area of the channel ( $A$ ) needed to safely pass  $Q_{10}$  can be calculated using  $A=Q_{10}/v = 2.0 \text{ cfs} / 2.2 \text{ fps} = 0.91 \text{ sf}$ . At  $d = 0.1$  ft.,  $A = 1.4 \text{ sf}$ . **The proposed design will safely convey the 10-year storm.**

The minimum depth of the channel ( $d_c$ ) may be determined by adding the required depths:

$$\begin{aligned} d_c &= d_{max} + d_{10 \text{ yr. storm}} + d_{freeboard} \\ &= 1.5 \text{ ft.} + 0.1 \text{ ft.} + 0.25 \text{ ft.} \\ &= 1.85 \text{ ft.} \quad \text{Use channel depth (d}_c\text{) = 2.0 ft.} \end{aligned}$$

Design details for the dry swale are shown in Figures C.2.14.

C.2.14 Dry Swale Design Details

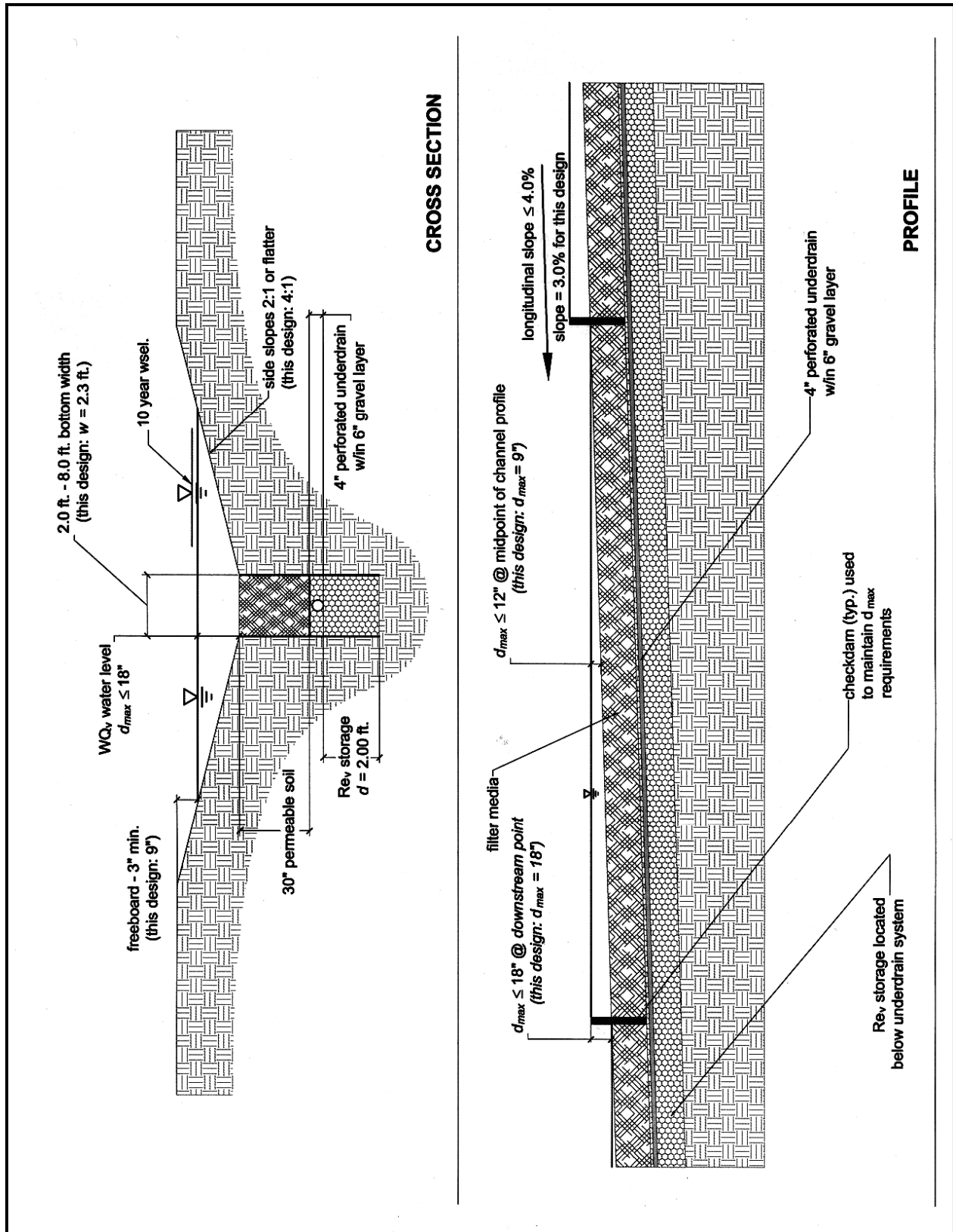

**Appendix**

**D.1**

**Testing Requirements for Infiltration,  
Bioretention and Sand Filter Subsoils**

### **General Notes Pertinent to All Testing**

1. For infiltration trench (I-1) and basin (I-2) practices, a minimum field infiltration rate ( $f$ ) of 0.52 inches per hour is required; lower rates preclude the use of these practices. For surface sand filter (F-1) and bioretention (F-6) practices, no minimum infiltration rate is required if these facilities are designed with a “day-lighting” underdrain system; otherwise these facilities require a 0.52 inch per hour rate.
2. Number of required borings is based on the size of the proposed facility. Testing is done in two phases, (1) Initial Feasibility, and (2) Concept Design.
3. Testing is to be conducted by a qualified professional. This professional shall either be a registered professional engineer, soils scientist or geologist and must be licensed in the State of Maryland.

### **Initial Feasibility Testing**

Feasibility testing is conducted to determine whether full-scale testing is necessary, screen unsuitable sites, and reduce testing costs. A soil boring is not required at this stage. However, a designer or landowner may opt to engage Concept Design Borings per Table D.1.1 at his or her discretion, without feasibility testing.

Initial testing involves either one field test per facility, regardless of type or size, or previous testing data, such as the following:

- \* on-site septic percolation testing, within 200 feet of the proposed BMP location, and on the same contour which can establish initial rate, water table and/or depth to bedrock,
- \* geotechnical report on the site prepared by a qualified geotechnical consultant, or
- \* Natural Resources Conservation Service (NRCS) County Soil Mapping showing an unsuitable soil group such as a hydrologic group “D” soil in a low-lying area or a Marlboro Clay.

If the results of initial feasibility testing as determined by a qualified professional show that an infiltration rate of greater than 0.52 inches per hour is probable, then the number of concept design test pits shall be per the following table. An encased soil boring may be substituted for a test pit, if desired.

**Table D.1.1 Infiltration Testing Summary Table**

<b>Type of Facility</b>	<b>Initial Feasibility Testing</b>	<b>Concept Design Testing (initial testing yields a rate greater than 0.52"/hr)</b>	<b>Concept Design Testing (initial testing yields a rate lower than 0.52"/hr)</b>
I-1 (trench)	1 field percolation test, test pit not required	1 infiltration test and 1 test pit per 50' of trench	not acceptable practice
I-2 (basin)	1 field percolation test, test pit not required	1 infiltration test and 1 test pit per 200 square feet of basin area	not acceptable practice
F-1 (surface sand filter)	1 field percolation test, test pit not required	1 infiltration test and 1 test pit per 200 square feet of filter area (no underdrains required*)	underdrains required
F-6 (bioretention)	1 field percolation test, test pit not required	1 infiltration test and 1 test pit per 200 square feet of filter area (no underdrains required*)	underdrains required

\* underdrain installation is still strongly recommended

### Documentation

Infiltration testing data shall be documented, and include a description of the infiltration testing method. This is to ensure that the tester understands the procedure.

### Test Pit/Boring Requirements

- a. Excavate a test pit or dig a standard soil boring to a depth of 4 feet below the proposed facility bottom;
- b. Determine depth to groundwater table (if within 4 feet of proposed bottom) upon initial digging or drilling, and again 24 hours later;
- c. Conduct Standard Penetration Testing (SPT) every 2' to a depth of 4 feet below the facility bottom;

## Appendix D.1 Testing Requirements for Infiltration Bioretention and Sand Filter Subsoils

---

- d. Determine United States Department of Agriculture (USDA) or Unified Soil Classification (USC) System textures at the proposed bottom and 4 feet below the bottom of the best management practice (BMP);
- e. Determine depth to bedrock (if within 4 feet of proposed bottom);
- f. The soil description should include all soil horizons; and
- g. The location of the test pit or boring shall correspond to the BMP location; test pit/soil boring stakes are to be left in the field for inspection purposes and shall be clearly labeled as such.

### **Infiltration Testing Requirements (field testing required)**

- a. Install casing (solid 5 inch diameter, 30" length) to 24" below proposed BMP bottom (see Figure D.1.1).
- b. Remove any smeared soiled surfaces and provide a natural soil interface into which water may percolate. Remove all loose material from the casing. Upon the tester's discretion, a two (2) inch layer of coarse sand or fine gravel may be placed to protect the bottom from scouring and sediment. Fill casing with *clean* water to a depth of 24" and allow to pre-soak for twenty-four hours.
- c. Twenty-four hours later, refill casing with another 24" of clean water and monitor water level (measured drop from the top of the casing) for 1 hour. Repeat this procedure (filling the casing each time) three additional times, for a total of four observations. Upon the tester's discretion, the final field rate may either be the average of the four observations, or the value of the last observation. The final rate shall be reported in inches per hour.
- d. May be done through a boring or open excavation.
- e. The location of the test shall correspond to the BMP location.
- f. Upon completion of the testing, the casings shall be immediately pulled, and the test pit shall be back-filled.

**Figure D.1.1** Infiltration Testing Requirements

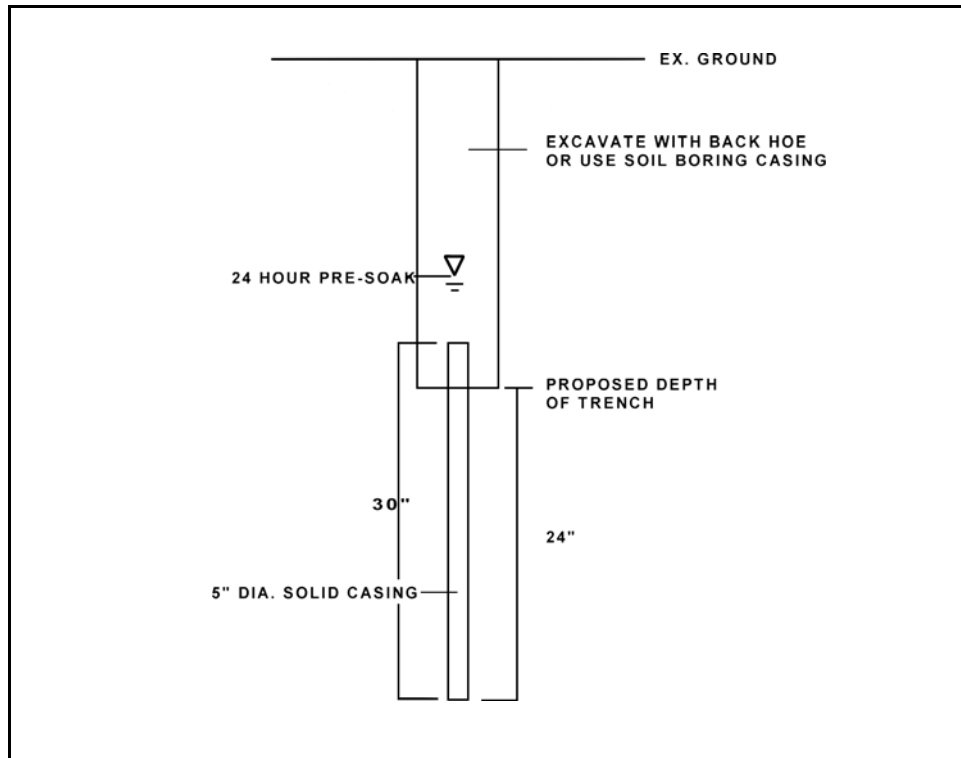

### Laboratory Testing

Use grain-size sieve analysis and hydrometer tests (where appropriate) to determine USDA soils classification and textural analysis. Visual field inspection by a qualified professional may also be used, provided it is documented. The use of lab testing to establish infiltration rates is prohibited.

### Bioretention Testing

All areas tested for application of F-6 facilities shall be back-filled with a suitable sandy loam planting media. The borrow source of this media, which may be the same or different from the bioretention area location itself, must be tested as follows:

If the borrow area is undisturbed soil one test is required per 200 square feet of borrow area. The test consists of “grab” samples at one foot depth intervals to the bottom of the borrow area. All samples at the testing location are then mixed, and the resulting sample is then lab-tested to meet the following criteria:

Appendix D.1 Testing Requirements for Infiltration Bioretention and Sand Filter Subsoils

---

- a) USDA minimum textural analysis requirements: A textural analysis is required from the site stockpiled topsoil. If topsoil is imported, then a texture analysis shall be performed for each location where the topsoil was excavated.

Minimum requirements:

sand 35 - 60%

silt 30 - 55%

clay 10 - 25%

- b) The soil shall be a uniform mix, free of stones, stumps, roots or other similar objects larger than one inch.
- c) Consult the bioretention construction specifications (Appendix B.3.8) for further guidance on preparing the soil for a bioretention area.

**Table D.1.2 Minimum Depth to Seasonably High Water Table**

<b>Region</b>	<b>Depth to water table for infiltration</b>	<b>Depth to water table for encased or lined facilities such as an underground concrete sand filter</b>
Lower Eastern Shore	2	0*
Remainder of State	4	0*

\*may need professional structural design



**Appendix  
D.2**

**Geotechnical Methods for Karst Feasibility  
Testing**

The following information on BMP design and SWM geotechnical testing in Karst areas has been adapted from the *Carroll County Water Resource*

*Management Manual and Ordinance* (CCWRM) dated July 2, 1996. For a complete discussion of these items, please refer to the Carroll County document.

### **Section 1: Stormwater Management in Karst Areas**

In general, stormwater runoff should not be concentrated and should be conveyed through vegetated areas; in addition, the facilities should be designed in accordance with the following standards:

- (1) Detention/retention ponds should be designed and constructed with a synthetic or clay liner approved by the local plan approval authority.
- (2) Discharges from SWM facilities or directly from impervious surfaces should not be routed within 1000 feet of the edge of any existing unremediated sinkhole. The flow should then be directed to an area not underlain by carbonate rock. Alternatively, these discharges may be routed to a stable watercourse via a pipe or lined channel.
- (3) Sinkholes occurring within stormwater management structures should be repaired within 72 hours of first observation of occurrence.
- (4) Liners: Where natural soil permeabilities are greater than  $10^{-6}$  cm/sec or  $1.4 \times 10^{-3}$  inches per hour for the two-foot interval below the depth of the proposed facility, a stable, low permeability liner shall be installed as follows:
  - (a) One foot of clay with a permeability less than  $10^{-7}$  cm/sec, or;
  - (b) Two feet of clay with a permeability less than  $10^{-6}$  cm/sec, or;
  - (c) Two feet of compacted soil with a permeability less than  $10^{-5}$  cm/sec with a 30 mil thick artificial liner with a permeability less than  $10^{-7}$  cm/sec, or;
  - (d) A very low permeability base constructed of concrete.

### **Section 2: Soils Investigation for Karst Areas**

The purpose of a karst investigation is to identify subsurface voids, cavities, fractures, or other discontinuities which could pose an environmental concern or a construction hazard to an

existing or proposed SWM facility. By definition, karst investigations are required only in areas suspected of containing carbonate rocks. The requirements outlined below should not be interpreted as all-inclusive. The design of any subsurface investigation should reflect the size and complexity of the proposed project.

The investigation should determine the nature and thickness of subsurface materials, including depth to bedrock and to the water table. Subsurface data may be acquired by backhoe excavation and/or soil boring. These field data should be supplemented by geophysical investigation techniques, deemed appropriate by a qualified professional. The data listed herein should be acquired under the direct supervision of a qualified geologist, geotechnical engineer, or soil scientist who is experienced in conducting such studies. Pertinent site information shall be collected which should include the following:

1. Bedrock characteristics (type, geologic contacts, faults, geologic structure, rock surface configuration).
2. Soil characteristics (type, thickness, mapped unit).
3. Photogeologic fracture traces.
4. Bedrock outcrop areas.
5. Sinkholes and/or other closed depressions.
6. Perennial and/or intermittent streams.

### **Section 3: Location of Borings**

Borings should be located to provide representative area coverage of the proposed facilities. The exact location of borings will be based on the following conditions or features:

1. In each geologic unit present, as mapped by the Maryland and U.S. Geological Surveys (USGS) and local county records.
2. Placed near on-site geologic or geomorphic indications of the presence of carbonate rock.
3. On photogeologic fracture traces.
4. Next to bedrock outcrop areas (i.e., ten feet from).
5. As near to identified sinkholes and/or closed depressions as possible.
6. Near the edges and center of the proposed facility, and spaced at equal distances from one another.

7. Near any areas identified as anomalies from any geophysical studies.

#### **Section 4: Number of Borings**

The density shall be dependent upon the type and size of the proposed facility such that a representative sampling is obtained, as follows:

1. Ponds/wetlands - a minimum of three per facility, or three per acre, whichever is greater with at least one along the centerline of the proposed embankment and the remainder within the proposed impoundment area.
2. Infiltration trenches - a minimum of 2 per facility.
3. Additional borings - to define lateral extent of limiting horizons, or site specific conditions, where applicable.

#### **Section 5: Depth of Borings**

Borings shall be extended to depths dependent upon bedrock type as follows:

1. Non-carbonate rocks - a minimum depth of 5 feet below the lowest proposed grade, within the facility unless auger/backhoe refusal is encountered.
2. Carbonate rocks - a minimum of 20 feet below ground surface or proposed grade; where refusal is encountered the boring may either be extended by rock coring or moving to an adjacent location within 10 linear feet of the original site, in order that the 20-foot minimum depth be reached.

#### **Section 6: Identification of Material**

All material penetrated by the boring shall be identified, as follows:

1. Description, logging, and sampling for the entire depth of the boring.
2. Any stains, odors, or other indications of environmental degradation.
3. A minimum laboratory analysis of two soil samples, representative of the material penetrated including potential limiting horizons, with the results compared to the field descriptions.
4. Identified characteristics shall include, as a minimum: color; mineral composition; grain

size, shape, and sorting; and saturation.

5. Any indications of water saturation shall be carefully logged, to include both perched and groundwater table levels, and descriptions of soils that are mottled or gleyed should be provided. Water levels in all borings shall be taken at the time of completion and again 24 hours after completion. The boring must remain fully open to total depth of these measurements.
6. When conducting a standard penetration test (SPT), estimation of soil engineering characteristics, including “N” or estimated unconfined compressive strength.

### **Section 7: Geophysical Investigation**

An electromagnetic terrain conductivity survey may be conducted over the entire area of the facility and extending outward to 200 feet beyond the boundaries of the proposed facility. This survey may be performed to provide a qualitative evaluation of the area to be utilized. The survey results may be used to identify “suspect areas” which will be further evaluated using borings. The use of this technique may reduce the total number of borings for a site by better defining “suspect areas.” This survey shall include appropriate techniques such that representative data are collected from a minimum depth of 20 feet below ground surface or the final proposed grade, whichever is deeper. These data shall then be correlated with boring data in the site area.

### **Section 8: Evaluation**

At least one subsurface cross section shall be provided. It should extend through a central portion of the proposed facility, using the actual or projected boring data and the geophysical data. In addition, an iso-conductivity map should be constructed. Finally, a bedrock contour map should be developed to include all of the geophysical and boring data. A sketch map or formal construction plan indicating the location and dimension of the proposed facility and line of cross section should be included for reference, or as a base map for presentation of subsurface data.

### **Section 9: Sinkhole Remediation**

Proper sinkhole remediation involves investigation, stabilization and final grading. For more information, please see the CCWRM, Section 4.2.

### **Section 10: Sinkhole Stabilization**

Sinkholes should be repaired by (1) reverse-graded backfilling, (2) concrete plugging, or (3) an

engineered subsurface structure. For more information on these methodologies, see the CCWRM, Section 4.2.2.

### **Section 11: Monitoring of BMPs in Karst Regions**

A water quality monitoring system installed, operated and maintained by the owner/operator may be required in a karst region. For areas requiring monitoring, at least one monitoring well shall be placed at a point hydraulically up gradient from the BMP and two (2) down gradient monitoring wells shall be provided within 200' of the facility. The wells shall be fitted with locking caps. Bi-annual sampling should take place, and an annual report should be filed with the plan approval authority.

**Appendix  
D.3**

**Short Cut Method for Wetland  
Drawdown Assessment**

### Appendix D.3. Short Cut for Wetland Drawdown Assessment

---

This section presents a simple method for calculating whether a stormwater pond or wetland has an appropriate water balance to maintain a wet pool over a 30-day period without rainfall. When conducting this analysis, the following should be considered:

1. Calculate maximum drawdown during periods of high evaporation and during an extended period of no appreciable rainfall.
2. The change in storage within a pond ( $\Delta V$ ) = Inflows - Outflows
3. Potential inflows: runoff, baseflow and rainfall
4. Potential outflows: infiltration, surface overflow and evaporation (and evapotranspiration)
5. Assume no inflow from baseflow, no losses for infiltration and because only the permanent pool volume is being evaluated, no losses for surface overflows.
6. Therefore,  $\Delta V = \text{runoff} - \text{evaporation}$

Using Design Example No. 1 - Reker Meadows (see Chapter 2.6) as an example and given the conditions in Table D.3.1 and table D.3.2, a wetland drawdown assessment may be determined as follows:

**Table D.3.1** Site Data from Design Example 1 for Sample Water Balance Analysis

Drainage Area	38.0 ac
Post Developed Conditions CN	78
2-yr. Design Rainfall Event	3.1"
2-yr. Design Storm Runoff	1.2"
Water Quality Volume ( $WQ_v$ )	1.08 ac-ft
Groundwater Recharge Volume ( $Re_v$ )	0.25 ac-ft
Surface Area of Wetland (minimum 1.5% of drainage area to BMP)	0.58 acres

A shallow wetland (W-1) will be designed to treat the water quality volume ( $WQ_v$ ) minus the groundwater recharge volume ( $Re_v$ ). Therefore, the permanent pool volume = 0.83 ac-ft.

**Table D.3.2** Evaporation Rates for Maryland Ponds  
(from Ferguson and Debo, "On-Site Stormwater Management", 1990)

	April	May	June	July	August	September
Precipitation (ft.)	0.30	0.35	0.32	0.36	0.38	0.31
Evaporation (ft.)	0.36	0.44	0.52	0.54	0.46	0.35



Calculate maximum drawdown during periods of high evaporation:

- Period of greatest evaporation occurs during the month of July (see Table D.3.2)
- Runoff Volume =  $P \times E$

where  $P$  = Precipitation

$E$  = Runoff Efficiency (ratio of NRCS 2 year storm runoff to rainfall depths)

- For CN = 78, Volume of Runoff (2 year storm) = 1.2"
- For Frederick County, 2 year storm rainfall = 3.1"
- $E = 1.2''/3.1'' = 0.39$
- Inflow =  $P \times E$   
 $= .36 \text{ ft} \times .39 = 0.14 \text{ ft}$   
over entire site area: (0.14 ft) (38 acres) = 5.32 ac-ft
- Outflow = surface area  $\times$  evaporation losses  
 $= 0.58 \text{ ac} \times 0.54 \text{ ft}$  (see Table D.3.2)  
 $= 0.31 \text{ ac-ft}$
- Inflow (5.32 ac-ft) is greater than Outflow (0.31 ac-ft) therefore, drainage area is adequate to support wet pond during normal conditions.

Check for drawdown over an extended period without rainfall:

- Use a 45 day interval using worst case conditions
- Highest evaporation occurs during July – 0.54 ft per month (see Table D.3.2)
- Calculate average evaporation per day =  $0.54 \text{ ft} / 31 \text{ days} = 0.017 \text{ ft/day}$
- Over 45 day interval, evaporation loss =  $45 \times .017 \text{ ft/day} = 0.78 \text{ ft}$
- Assume surface of the permanent pool may drop up to 0.78 ft (9.4") over this interval. Therefore, to be safe, specify vegetation for the aquatic shelves (to 10") that can tolerate periods of drawdowns.

## Reference

Ferguson, B. and T.N. Debo. 1990. On-Site Stormwater Management - Applications for Landscape and Engineering. Van Nodstrandt, Reinhold, New York.

**Appendix**

**D.4**

**Stormwater Criteria for Maryland  
Critical Area IDA Zone**

This Appendix has been adapted from the document

Urban Stormwater Quality Guidance for the  
Maryland Chesapeake Bay Critical Area  
in Intensely Developed Areas

Prepared by:  
Peter Kumble  
Lorraine Herson-Jones  
Thomas Schueler

Additional Information on the 10% Rate, including an applicants guide, can be obtained from  
the:

Chesapeake Bay Critical Area Commission  
45 Calvert Street  
Annapolis, MD 21401  
(410) 974-2426

## Background

### *What is the Critical Area?*

The Chesapeake Bay Critical Area Act, passed by the Maryland General Assembly in 1984, is designed to help protect the Chesapeake Bay and its tributaries from resource degradation primarily resulting from development activity. In 1986, the more specific and comprehensive Critical Area Criteria were adopted to implement the law. **The “Critical Area” is defined as all water and submerged lands of the Chesapeake Bay to the head of tide, and all land and water within 1000 feet of Mean High Water or from the edge of tidal wetlands.** The Criteria mandate certain restrictions on the use of land within this area. However, the responsibility for implementing the Criteria is delegated to local governments, where zoning and other land use controls have traditionally been carried out.

### *What is an IDA?*

In writing the Criteria, the Chesapeake Bay Critical Area Commission was cognizant of the fact that development already existed within the Critical Area. The Criteria also written with an implicit acceptance of a limited and controlled level of additional development or redevelopment. One particular class of land use, termed **“Intensely Developed Areas,”** or **IDAs**, was identified as areas where continued growth could be accommodated through redevelopment and/or new development. Local governments desiring to permit or promote such projects within the Critical Area have been encouraged to direct such efforts within the IDA.

### *What does the 10% Rule mean?*

IDAs are designated to each local jurisdiction and are characterized as intensely developed areas that are predominately commercial, residential or industrial in nature. The Critical Area Criteria require that any development within the IDA be accompanied by urban **“best management practices (BMPs)”** to help mitigate potential water quality impacts associated with stormwater runoff. The Criteria further specify that these practices should be capable of removing pollutant loads generated from the development site to a level at least 10% below the load generated at the site prior to development. This requirement is commonly referred to as the **“10% Rule.”**

## Introduction

The requirements set forth in this document relate only to the requirements of the Chesapeake Bay Critical Area Act passed by the Maryland General Assembly in 1984 as well as the associated criteria passed in 1986. Under this act, development and redevelopment activities shall be required to use stormwater management practices appropriate to site development which achieves a ten (10%) percent reduction of pre-development pollutant loadings.

### 10% Rule Application Process

**A** Is the proposed development in the IDA of the Critical Area?

If yes, then go to Step B.  
If not, the 10% process does not apply.

**B** Is the impervious surface proposed for the entire project greater than 250 square feet? If not, the 10% process does not apply.

If yes, then go to Step C.

**C** Is the proposed development for a single lot – single family home?

If yes, go to Step D.  
If not, use the Standard Application Process and go to Part II of the Applicant's Guide.

**D** Use the Residential Water Quality Management Process.

**E** Go to Part III of the Applicant's Guide.

This section details a step-by-step approach for compliance with the 10% Rule. It is important to note that these requirements are designed to provide water quality treatment of urban runoff and that other site environmental features cannot be substituted towards compliance. For example, environment requirements for waste water treatment plants cannot be substituted for urban runoff BMPs— the Six Step Standard Application process or Standard Procedure.

Two application processes have been developed for 10% Rule compliance in recognition of the broad scale of development that occurs within the Critical Area.

- In the Standard Procedure, computations of pre- and post-development pollutant loadings and pollutant removal efficiencies of BMPs are used to determine compliance with the 10% Rule.
- The second procedure provides a streamlined process for individual, residential lot development. If the proposed development is eligible, the applicant must submit a Residential Water Quality Management Plan for approval.

compliance:

The 10% Rule provides three different approaches for

- 1) A reduction in impervious surface may lower post-development levels; therefore,  $I_{\text{post}}$  is lower, and hence,  $I_{\text{post}}$  (post-development load) is lower;

- 2) A stormwater management BMP may remove pollutants from the Critical Area portion of the site equal to the 10% reduction;
- 3) A stormwater management BMP may remove pollutants from the Critical Area portion of the site and portions outside of the Critical Area equal to the 10% reduction.

*Who must comply?*

An individual planning development or re-development of land in the Critical Area District zoned as an Intensely Developed Area (IDA) must comply with the 10% Rule. As mentioned above, IDA refers to the land-use management classification as determined by the Chesapeake Bay Critical Area Commission and incorporated into a local government's Critical Area program. IDAs are areas where residential, commercial, institutional, and/or industrial developed land uses predominate, and where relatively little natural habitat occurs. IDAs also have at least one of the following characteristics:

- A density of development equal to or greater than four dwellings per acre;
- Presence of public water and sewer systems with a density of greater than three units per acre; or,
- Concentration of industrial, commercial, or institutional uses. In addition, these features are concentrated in an area of at least 30 adjacent acres.

*What must be submitted?*

For persons proposing development or re-development in areas designated as an IDA on a local Critical Area map, the specific submittal requirements vary from jurisdiction to jurisdiction. Applicants should refer to their local Critical Area Program guidelines for preliminary and final site plan or subdivision plan submittal requirements. As mentioned earlier, this Applicant's Guide contains the minimum recommended submittal requirements for two separate 10% Rule application processes. Schedules for submittal of either document may vary among Critical Area jurisdictions.

*What if my project is small?*

Check to see if the project meets the criteria for the Residential Water Quality Management Plan. This program is designed to ease the application process for individual lot residential development or improvements that involve disturbances of 250 square feet or greater. Projects smaller than 250 square feet of disturbance are exempted from the requirements of 10% Rule.

*What if my project will be completed in phases?*

Applicants anticipating that their development will occur in phases are required to submit a conceptual plan indicating the entire scope of work for preliminary review and approval. This will ensure that the impacts of the project are evaluated in their entirety.

*Who do I submit it to?*

Before commencement of construction, all plans indicating proposed development, (e.g. site plans, building permits, subdivision plans), shall be submitted to the county or municipality department which is generally responsible for the administration and enforcement of Chesapeake Bay Critical Area Program regulations. In most jurisdictions, there is a zoning department that handles Critical Area projects.

*How does this program relate to other stormwater management programs?*

Other local or state stormwater regulations may require additional stormwater requirements or submittal information. For example, the state stormwater requirements require that stormwater designs be assessed according to the state priorities, (for example: infiltration of runoff as top priority, followed by wet ponds, etc.). State or local stormwater requirements may also specify control of larger storms for quantity or flood safety control purposes. It is possible to meet various design requirements within one facility, but local and state programs must be addressed in addition to the requirements outlined within this document.

*When must the application be submitted?*

Any application process for the 10% Rule should parallel the plan review process, for example: a conceptual 10% Rule Application should be submitted as part of the preliminary review followed by a final 10% application at the final plan review stage. Upon receipt of the site plan, the local reviewing agency may conduct a review soliciting technical comments from other departments, agencies, and officials. Although the process varies between jurisdictions, the site plan shall be preliminarily approved, subject to final approval, assuming it meets all requirements.

The Standard Application Process provides a six-step method for comparing pollutant loads before and after development, and assessing the appropriate BMP for a given site. The pollutant loading methodology is based on relationships between surface imperviousness and concentrations of pollutants found in urban runoff (Schueler 1987).

**Table D.4.1** Six Step Method of the Standard Application Process

<b>Worksheet A</b>	
STEP #1	Calculate Site Imperviousness
STEP #2	Calculate Pre-Development Pollutant Load
STEP #3	Calculate Post-Development Pollutant Load
STEP #4	Calculate Pollutant Removal Requirement
STEP #5	Identify Feasible Urban BMP
<b>Worksheet B</b>	
STEP #6	Define Off-Site Compliance
then..	Submit Application to Critical Area Plan Reviewer

**STEP 1: Calculate Site Imperviousness**

In this step, the applicant will describe imperviousness of pre- and post- development site conditions. In general, impervious surfaces are human-made surfaces that are devoid of vegetation. Refer to Table D.4.2 for detailed definitions of imperviousness.

**Impervious Measurement**

- Imperviousness must be measured directly from the most recent site plan.
- A table of measured values (planimeter, preferred) listed specifically for each impervious surface type (roads, rooftops, etc.) must be submitted.
- Estimates of imperviousness based on land use types by computer generated surface runoff programs (e.g. TR-55), are not appropriate for submission.
- If land is subdivided prior to construction, it is recommended that a 10% Application is submitted at the time of initial subdivision, with imperviousness calculated using maximum building envelopes and proposed road layouts. This submittal process is recommended so that the entire project may be assessed as a whole.

**Define Development Category**

Using existing site imperviousness data, the proposed development must be categorized as 1) new development, 2) redevelopment, or 3) single lot residential.

- 1) New Development:                      pre-development imperviousness < 15%
- 2) Re-development:                      pre-development imperviousness > 15%



- 3) Single Lot Residential: projects involving an individual lot of residential development which exceed 250 square feet in site disturbance.

**Table D.4.2** Definition of Imperviousness

Impervious Surfaces are those that:		
1) impede the natural infiltration of rainfall into underlying soils; and,		
2) result in an increased volume of surface runoff to adjacent soils. As a simple rule, human-made surfaces that are not vegetated will be considered impervious (BMPs will be exempted from this definition).		
<u>Surface</u>	<u>Impervious</u>	<u>Design Suggestions</u>
<b>Roads</b>		
paved/concrete	yes	<ul style="list-style-type: none"> <li>• minimize road width</li> <li>• avoid curb and gutters; use grassed swales</li> </ul>
gravel	yes	
dirt	yes	
<b>Driveways</b>		
paved/concrete	yes	<ul style="list-style-type: none"> <li>• minimize surface area</li> <li>• use gridded pavers or porous pavement in areas of low usage</li> </ul>
gravel	yes	
dirt	yes	
grid pavers	no	
porous pavement	yes	
<b>Sidewalks/paths</b>		
paved	yes	<ul style="list-style-type: none"> <li>• minimize surface area</li> <li>• disconnect imperviousness; combine with vegetation</li> </ul>
gravel	yes	
grid pavers	no	
porous pavement	no	
wood chip	no	
<b>Rooftops</b>	yes	<ul style="list-style-type: none"> <li>• use sheet-flow spouting, dry wells or french drains</li> </ul>
<b>Decks</b>	yes	<ul style="list-style-type: none"> <li>• treat runoff under deck area</li> </ul>
<b>Swimming pools/ponds</b>	yes	

**STEP 2: Calculate Pre-Development Pollutant Load**

In this step the applicant calculates the storm loadings of phosphorous from the site prior to development (see Technical Guide “Simple Method for Calculating Phosphorous Export”). The equation shown in Table D.4.3 is a simplification of the equations presented in the 1987 10% Document. Two loading formulas are used based on the development category (redevelopment or new development) and site imperviousness. The information needed for these calculations include:

- the area of the site within the IDA of the Critical Area
- pre-development site imperviousness.

**Table D.4.3** Method for Calculating Pre-Development Phosphorous Loading

<b>Pre-development Phosphorous Loading:</b>		$L_{pre} = (R_v)(C)(A) 8.16$
		$R_v = 0.05 + 0.009(I)$
where:		
$L_{pre}$	=	average annual load of total phosphorous exported from the site in pounds per year
$R_v$	=	runoff coefficient, which expresses the fraction of rainfall which is converted into runoff
$C$	=	flow-weighted mean concentration of phosphorous in urban runoff (mg/l)
		$C = 0.26$ if pre-development $I < 20\%$
		$C = 1.08$ if pre-development $I \geq 20\%$
$A$	=	area of the site within the IDA Critical Area (acres)
8.16	=	includes regional constants and unit conversion factors
$I$	=	site imperviousness ( $I = 75$ if site is 75% impervious)
<b>New Development Phosphorous Loading:</b>		$L_{pre} = 0.5 (A)$
where:		
$L_{pre}$	=	average annual load of total phosphorous exported from the site in pounds per year
$A$	=	area of the site within the IDA Critical Area (acres)

**STEP 3: Calculate Post-Development Pollutant Load**

The next step involves computing the post-development pollutant load from the site. Again, an abbreviated version of the Simple Method (Schueler, 1987), described in Step 2 is used for the calculations. The equations to be used to determine post-development pollutant loads follows below.

**Table D.4.4** Method for Computing Post-Development Pollutant Loadings

<b>Post-Development Pollutant Loading:</b>	$L_{post} = (R_v)(C)(A)(8.16)$
	$R_v = 0.05 + 0.009(I)$
where:	
$L_{post}$	= average annual load of total phosphorous exported from the site through storm runoff in pounds per year
$R_v$	= runoff coefficient, which expresses the fraction of rainfall which is converted into runoff
$I$	= site imperviousness ( $I = 75$ if site is 75% impervious)
$C$	= flow-weighted mean concentration of the pollutant in urban runoff (mg/l) $C = 0.26$ if new development activity $C = 1.08$ if redevelopment activity
$A$	= area of the development site (acres)
8.16	= includes regional constants and unit conversion factors

**STEP 4: Calculate the Pollutant Removal Requirement**

Phosphorous pollutant loads generated from the site must be reduced so that they are 90% or less of the load that is generated prior to development. The amount of phosphorous that must be removed through the use of stormwater BMPs is called the Pollutant Removal Requirement. The equation in Table D.4.5 expresses this term numerically.

**Table D.4.5** Computing Pollutant Removal Requirements

Removal Requirement	=	Post-development phosphorous load - (0.9) Pre-development phosphorous load
		$RR = L_{post} - 0.9 (L_{pre})$

**STEP 5: Identify Feasible Urban Best Management Practices (BMP)**

Urban BMP options must be shown to be feasible for the site both in terms of physical suitability and pollutant removal capabilities (see Volume 1, Chapter 4). It should be noted that the BMPs which survive the screening procedure still need to undergo more detailed design checks and field tests to confirm that they are actually feasible. Evidence of site feasibility will be required as part of the final submittal package.

**Table D.4.6** Estimate of Pollutant Load Removed by Each BMP

$\text{Load Removed} = (\text{Post-development Load})(\text{Removal Rate})$ $LR = L_{\text{post}} (RR)(\% \text{ Drainage Area Served})$
--

If the Load Removed is equal to or greater than the Pollutant Removal Requirement computed in STEP 4, then the on-site BMP complies with the 10% Rule. If not, the designer must evaluate alternative BMP designs to achieve higher removal efficiencies.

Tables D.4.7 and D.4.8 provide updated phosphorous removal rates for stormwater BMPs used in this manual, based on a comprehensive national survey of pollutant removal performance monitoring data (Brown and Schueler, 1997).

**Table D.4.7** Updated Critical Area Keystone Phosphorous Removal Rates

<b>CODE</b>	<b>BMP LIST</b>	<b>TP%</b>
P-1	Micropool ED	40
P-2	Wet Pond	50
P-3	Wet ED Pond	60
P-4	Multiple Pond	65
P-5	Pocket Pond	50
W-1	Shallow Wetland	40
W-2	ED Wetland	40
W-3	Pond/Wetland	55
W-4	Pocket Wetland	40
I-1	Infiltration Trench	65
I-2	Infiltration Basin	65
F-1	Surface Sand Filter	50
F-2	Underground Sand Filter	50
F-3	Perimeter Sand Filter	50
F-4	Organic Filter	50
F-5	Pocket Sand Filter	40
F-6	Bioretention	50
O-1	Dry Swale	65
O-2	Wet Swale	40

**Table D.4.8** TP Removal Rates for BMPs Not on the List

<b>BMP LIST</b>	<b>TP%</b>
Detention Facility - 2	10
Dry ED Pond - 7	20
Open Channels - 7	-15
Biofilter - 2	25
Dry Well	Nd
Catchbasin - 1	5
Filterstrip - 1	7
Water Quality Inlets - 1	0

Source: Brown and Schueler, 1997, National Pollutant Removal Database for Stormwater BMPs

**STEP 6: Define Off-Site Compliance**

In the event that on-site BMPs cannot fully meet the pollutant removal requirement and on-site design cannot be changed, an option exists for off-site mediation, otherwise known as an Offset Project. Of primary concern is that the project be associated with pollutant removal or water quality protection for water bodies within the same sub-watershed as the development project. Similarly, off-site projects should be designed to minimize maintenance requirements. In such cases where this is not feasible, a maintenance agreement should be established so as to insure long-term water quality protection. Table D.4.9 provides a prioritized list of potential offset projects.

**Table D.4.9** Prioritized List of Potential Offsite Projects

Having shown that on-site compliance is not feasible, the applicant may choose from the following Offset options in order of preference.

1. Construction and operation of an off-site BMP, sized to meet the removal requirements.
2. Retrofit an existing BMP or pond structure.
3. Retrofit an existing storm drain system to encourage infiltration.
4. Reduce the imperviousness of an existing property through reforestation.
5. Implement a riparian reforestation project (0.5 acres of tree planting per lb of removal requirement). Planting plan must meet local Critical Area reforestation standards, or Maryland Forest Conservation Manual, if no local standards exist.
6. In rural jurisdictions where retrofit options are limited, finance the installation of structural agricultural BMP for a farm with a NRCS approved conservation plan.
7. Other innovative options: restore a degraded tidal or non-tidal wetland that has been disturbed by previous urban or agricultural drainage activity. This may be accomplished through removal of fill, restoration of original water circulation patterns, and wetland plantings.

**Appendix**

**D.5**

**Documentation of BMP Ability to Meet  
the 80% TSS Removal Requirement**



## Appendix D.5. Documentation of BMP Ability to Meet the 80% TSS Removal Requirement

---

BMPs employed at new development in the State of Maryland are now required to meet a performance standard under the recently issued CZARA Coastal Zone 6217(g) management measures guidance (US EPA, 1993). The specific management measures read “After construction is completed and the site is permanently stabilized, reduce the average annual total suspended solid (TSS) loadings by 80% percent...on an average annual basis.”

Based on the 90% capture sizing criteria and published pollutant removal performance data, it may be presumed that the BMPs contained on the Acceptable BMP List outlined in Chapter 2 can meet the 80% TSS removal performance standard, if they are designed in accordance with the BMP performance criteria outlined in Chapter 3. The Acceptable BMP List will be periodically updated as new monitoring research is conducted and new stormwater treatment technologies are tested.

Table 1 shows the median sediment removal rate measured or projected for the nineteen stormwater BMPs currently on the approved list. The Table was developed as part of a national assessment of stormwater BMP monitoring research by the Center for Watershed Protection (Brown and Schueler, 1997).

It should be clearly noted that the median values were obtained from a range of research studies that varied widely in respect to geography, climate, design, treatment volume, sampling intensity, and removal efficiency calculation method. In particular, the averages for some pond and wetland designs reflect facilities that were under-sized or poorly designed, which tends to skew averages lower than they would otherwise be. Consequently, the numbers in Table 1 should be considered only as an indicator of expected pollutant removal performance in the State of Maryland.

As can be seen from Table 1, many BMPs on the list are capable of meeting the 80% TSS removal requirement. Nine of the BMPs, however, had median removal rates that ranged from 60% and 79%. As noted earlier, these slightly lower removal rates may have been caused by the fact that datasets include some under-sized or poorly designed practices that reduce the overall median.

In addition, performance monitoring data was not available to assess five practices, and their sediment removal rate had to be projected based on the performance of similar systems. They are:

- P-5 Pocket Pond (presumed to be similar to P-2)
- I-2 Infiltration Basin (published rate based on land application studies [Schueler, 1987])
- F-2 Underground Sand Filter (presumed to be similar to F-1)
- F-5 Pocket Sand Filter (presumed to be similar to F-1)
- F-6 Bioretention (presumed to be similar to O-1)

**Table D.5.1** TSS Removal Performance List

Appendix D.5. Documentation of BMP Ability to Meet the 80% TSS Removal Requirement

ACCEPTABLE BMPs	N	TSS	80% ?
P-1 Micropool ED	6 (a)	61	yes (b)
P-2 Wet Pond	30	77	yes
P-3 Wet ED Pond	6	60	yes (b)
P-4 Multiple Pond	pr- W-3	72	yes
P-5 Pocket Pond	pr- W-4	nd	yes
W-1 Shallow Wetland	14	84	yes
W-2 ED Wetland	5	62	yes (b)
W-3 Pond/Wetland	11	72	yes (b)
W-4 Pocket Wetland	1	76	yes (b)
I-1 Infiltration Trench	2	89	yes
I-2 Infiltration Basin	0	nd	yes
F-1 Surface Sand Filter	6	83	yes
F-2 Underground Sand Filter	see F-1	nd	yes
F-3 Perimeter Sand Filter	3	79	yes
F-4 Organic Filter	2	81	yes
F-5 Pocket Sand Filter	0	nd	yes
F-6 Bioretention	0	nd	yes (pr)
O-1 Dry Swale	4	93	yes
O-2 Wet Swale	5	74	yes
<p>Notes:  N = number of BMPs sampled  nd = No data  pr = projected removal , based on similar facilities  (a) data from dry ED ponds without micropools  (b) 80% removal can be achieved under proposed design criteria, current database is biased by under-sized or poorly designed facilities</p>			

**References**

Brown, W. and T. Schueler. 1997. National Pollutant Removal Performance Database for Stormwater BMPs. Center for Watershed Protection. Chesapeake Research Consortium. 220 pp.

U.S. EPA. 1993. Guidance Specifying Management Measures for Sources of Nonpoint Pollution in Coastal Waters. Issued under authority of Section 6217(g) of the Coastal Zone Act Reauthorization Amendments of 1990. No. 840-B-92-002. EPA Office of Water. Washington, D.C.

**Appendix**

**D.6**

**Industrial Stormwater NPDES Permit  
Requirements**

**Section D.6.1 Standard Industrial Classification (SIC) Code**

**Identified by EPA in 40 CFR 122.26(b)(14)(i through xi):**

- (i) Facilities subject to stormwater effluent limitations...  
No specific SIC codes cited. [Contact MDE/WMA for SIC number if not identified previously on another NPDES permit; 410-631-3543 or 410-631-3323.]
- (ii) 24 (except 2434) Lumber and Wood Products, Except Furniture  
2434 - Wood Kitchen Cabinets  
26 (except 265 and 267) Paper and Allied Products  
265 - Paperboard Containers and Boxes  
267 - Converted Paper and Paperboard Products, Except Containers and Boxes  
28 (except 283) Chemicals and Allied Products  
283 - Drugs  
29 Petroleum Refining and Related Industries  
31 Leather and Leather Products  
32 (except 323) Stone, Clay, Glass, and Concrete Products  
323 - Glass Products made of Purchased Glass  
33 Primary Metal Industries  
344 Fabricated Structural Metal Products  
373 Ship and Boat Building and Repairing
- (iii) 10 Metal Mining  
12 Coal Mining  
13 Oil and Gas Extraction (including facilities where stormwater comes into contact with overburden or raw materials)  
14 Mining and Quarrying of Nonmetallic Minerals, Except Fuels
- (iv) Hazardous waste treatment, storage or disposal facilities.  
No specific SIC codes cited. [Contact MDE/WMA for SIC number if not identified previously on another NPDES permit; 410-631-3543 or 410-631-3323.]
- (v) Landfills, land application sites, and open dumps...  
No specific SIC codes cited. [Contact MDE/WMA for SIC number if not identified previously on another NPDES permit; 410-631-3543 or 410-631-3323.]
- (vi) Facilities involved in the recycling of materials...  
including, but not limited to;  
5015 Motor Vehicle Parts, Used  
5093 Scrap and Waste Materials

## Appendix D.6. Industrial Stormwater NPDES Permit Requirements

---

- (vii) Steam electric power general facilities...  
No specific SIC codes cited. [Contact MDE/WMA for SIC number if not identified previously on another NPDES permit; 410-631-3543 or 410-631-3323.]
  
- (viii) Transportation facilities classified as:
  - 40 Railroad Transportation
  - 41 Local and Suburban Transit and Interurban Highway Passenger Transportation
  - 42 (except 4221-4225) Motor Freight Transportation and Warehousing
    - 4221 - Farm Product Warehousing and Storage
    - 4222 - Refrigerated Warehousing and Storage
    - 4225 - General Warehousing and Storage
  - 43 United States Postal Service
  - 44 Water Transportation
  - 45 Transportation by Air
  - 5171 Petroleum Bulk Stations and Terminals
  
- (ix) Treatment works treating domestic sewage...  
No specific SIC codes cited. [Contact MDE/WMA for SIC number if not identified previously on another NPDES permit; 410-631-3543 or 410-631-3323.]
  
- (x) Construction Activity  
See attached SIC code list for construction activity [Major Group Number 15].
  
- (xi)
  - 20 Food and Kindred Products
  - 21 Tobacco Products
  - 22 Textile Mill Products
  - 23 Apparel and other Finished Products made from Fabrics and Similar Materials
  - 2434 Wood Kitchen Cabinets
  - 25 Furniture and Fixtures
  - 265 Paperboard Containers and Boxes
  - 267 Converted Paper and Paperboard Products, Except Containers and Boxes
  - 27 Printing, Publishing, and Allied Industries
  - 283 Drugs
  - 285 Paints, Varnishes, Lacquers, Enamels, and Allied Products
  - 30 Rubber and Miscellaneous Plastics Products
  - 31 (except 311) Leather and Leather Products
    - 311 - Leather Tanning and Finishing
  - 323 Glass Products, made of Purchased Glass
  - 34 (except 3441) Fabricated Metal Products, Except Machinery and Transportation Equipment
    - 3441 - Fabricated Structural Metal
  - 35 Industrial and Commercial Machinery and Computer Equipment
  - 36 Electronic and other Electrical Equipment and Components, Except Computer Equipment

## Appendix D.6. Industrial Stormwater NPDES Permit Requirements

---

- 37 (except 373) Transportation Equipment
  - 373 - Ship and Boat Building and Repairing
- 38 Measuring, Analyzing, and Controlling Instruments; Photographic, Medical and Optical Goods; Watches and Clocks
- 39 Miscellaneous Manufacturing Industries
- 4221 Farm Product Warehousing and Storage
- 4222 Refrigerated Warehousing and Storage
- 4225 General Warehousing and Storage

Section D.6.2 General Discharge Permit - Sample

**GENERAL DISCHARGE PERMIT FOR STORM WATER ASSOCIATED WITH  
INDUSTRIAL ACTIVITIES**

**GENERAL DISCHARGE PERMIT NO. 97-SW-**

**GENERAL NPDES PERMIT NO. MDR\_\_\_\_\_**

**Effective Date:** \_\_\_\_\_

**Expiration Date:** \_\_\_\_\_

*Part I. APPLICABILITY.*

**A. Geographic Coverage.** This permit covers all areas of the State of Maryland.

**B. Eligible Discharges.** This permit may cover all storm water discharges associated with industrial activity, as defined in 40 CFR 122.26, that discharge to surface waters of the State. Such discharges may be commingled with wastewater or water discharges not regulated by this permit. This permit also covers storm water discharges not included in 40 CFR 122.26 that the Department determines would, if not regulated by a permit, be likely to contribute to a violation of a water quality standard or be a significant contributor of pollutants to waters of the State, either surface or ground.

**C. Ineligible Discharges.** The following discharges are not covered under this general permit.

1. Storm water discharges from any construction activity, as defined in 40 CFR 122.26, except for construction activity associated with an industrial facility that is or will be covered by this permit;

2. Storm water discharges that are regulated by effluent limitation guidelines. All or part of the storm water from the following industries are covered by effluent limitation guidelines: cement manufacturing (40 CFR 411), feedlots (40 CFR 412), fertilizer manufacturing (40 CFR 418), petroleum refining (40 CFR 419), phosphate manufacturing (40 CFR 422), steam electric generating (40 CFR 423), coal mining (40 CFR 434), mineral mining and processing (40 CFR 436), ore mining and dressing (40 CFR 440), and asphalt emulsion (40 CFR 443);

3. Storm water discharges associated with industrial activity from inactive mining or inactive oil and gas operations occurring on federal lands; and

4. Storm water discharges whose NPDES permit has been terminated (other than at the request of the permittee) or denied, or those for which the Department requires an individual permit or an alternative general permit.



***D. Individual Permit or Another General Permit Required.***

1. Any person who conducts activities which are covered by this General Permit and does not have a valid individual discharge permit is required to apply for coverage under this General Permit within 60 days of the issuance of the permit.

2. The Department may require any person authorized by this permit to apply for and obtain an individual State or State/NPDES discharge permit or to obtain coverage under another general permit. If an owner or operator fails to submit, in a timely manner, an application for an individual State or State/NPDES discharge permit or a Notice of Intent (NOI) for another general permit as required by the Department under this condition, the applicability of this permit to the owner or operator is automatically terminated at the end of the day specified by the Department for the application or NOI submittal.

3. Any person authorized by this permit may request to be excluded from coverage under this permit by applying for an individual State or State/NPDES discharge permit or requesting coverage under another general permit. The Department may grant this request by issuing an individual State or a State/NPDES discharge permit or by granting coverage under another general permit, if the reasons cited by the owner or operator are adequate to support the request.

4. When an individual State or State/NPDES discharge permit is issued to a person otherwise subject to this permit, the applicability of this permit to the permittee is automatically terminated on the effective date of the individual State or State/NPDES discharge permit.

5. If there is evidence indicating potential or realized impacts on water quality due to any activity covered by this permit, the owner or operator of such discharge may be required to obtain an individual State or a State/NPDES discharge permit or coverage under another general permit.

6. If a person otherwise covered under this permit is denied coverage under an individual State or a State/NPDES discharge permit, or another general permit, the denial automatically terminates, on the date of the denial, the person's coverage under this general permit, unless otherwise specified by the Department.

7. The Department may terminate coverage under this general permit for an existing permittee if the Department finds that:

a. The NOI contained false or inaccurate information;

b. Conditions or requirements of the discharge permit have been or are

about to be violated;

c. Substantial deviation from plans, specifications, or requirements has occurred;

d. The Department has been refused entry to the premises for the purpose of inspecting to insure compliance with the conditions of the discharge permit;

e. A change in conditions exists that requires temporary or permanent reduction or elimination of the permitted discharge;

f. Any State or federal water quality stream standard or effluent standard has been or is likely to be violated; or

g. Any other good cause exists for denying coverage under this permit.

***E. Authorization.*** To be authorized to discharge under this general permit, a person is required to submit an NOI in accordance with the requirements of Part III of this permit, to pay the required fee, and to comply with the terms and conditions of this permit. Coverage under this permit is effective on the date that the NOI is acknowledged by the Department and the NOI fee is paid to the Department in accordance with the terms stipulated in Part III below. A person who submits such an NOI is notified of its acceptance by the Department, complies with the terms and conditions of this permit, and pays the required fee is authorized to discharge under the terms and conditions of this permit.

If the NOI fee is paid by a check which does not clear for any reason, the person will be given 30 calendar days to make proper payment including any interest and other charges that are due. If payment is not made within this time, coverage under this permit shall be considered void from the outset. The permittee should save the cancelled check, a copy of the completed NOI, and related documents. These documents shall be provided to the Department upon request.

***F. Transfer of Authorization.***

1. The authorization under this permit is not transferable to any person except in accordance with this section.

2. Authorization to discharge under this permit may be transferred to another person if:

a. The current permittee notifies the Department (Industrial Discharge Permits Division with copy sent to Inspection and Compliance Program) in writing of the proposed transfer;

b. A written agreement, indicating the specific date of the proposed transfer of permit coverage and acknowledging the responsibilities of the current and new permittee for compliance with the terms and conditions of this permit, is submitted to the Department;

c. The new permittee either confirms in writing that the type of discharge, number of outfalls, and other information given on the original NOI remain correct or updates this information;

d. The new permittee confirms in writing that either they will follow the existing storm water pollution prevention plan or that they have developed a new plan; and

e. Neither the current permittee nor the new permittee receives notification from the Department, within 30 days of receipt of items I.F.2.a through d above, of intent to terminate coverage under this permit.

3. The Department may continue coverage for the new permittee under this permit or may require the new permittee to apply for and obtain an individual State or State/NPDES discharge permit or obtain coverage under another general permit.

4. A new owner of a facility is responsible for any fees unpaid by the former owner.

***G. Continuation of an Expired General Permit.*** An expired general permit continues in force and effect until a new general permit is issued; for the next 60 days provided the permittee submits a new NOI and fee within that period; or until the general permit is revoked or withdrawn. Only those permittees authorized to discharge prior to the expiration of the general permit are covered by the continued permit.

## ***Part II. Definitions.***

***A. "Best management practices (BMP)"*** means schedules of activities, prohibitions of practices, maintenance procedures, and other management practices to prevent or reduce the pollution of waters of this State. BMP also include treatment requirements, operating procedures, and practices to control plant site runoff, spillage or leaks, sludge or waste disposal, or drainage from raw materials storage.

***B. "CFR"*** means Code of Federal Regulations.

***C. "COMAR"*** means Code of Maryland Regulations.

**D. "Construction activity"** means clearing, grading, and excavation activities except: operations that result in the disturbance of less than five acres (or whatever threshold is currently specified in 40 CFR 122.26) of total land area which are not a part of a larger common plan of development or sale.

**E. "Department"** means the Maryland Department of the Environment. Unless stated otherwise, all submissions to the Department shall be directed to the attention of the Industrial Discharge Permits Division.

**F. "Federal Clean Water Act"** means the federal Water Pollution Control Act Amendments of 1972, its amendments and all rules and regulations adopted thereunder.

**G. "General permit"** means a discharge permit issued for a class of dischargers.

**H. "Ground water"** means underground water in a zone of saturation.

**I. "Includes" or "including"** means includes or including by way of illustration and not by way of limitation.

**J. "NPDES permit"** means a National Pollutant Discharge Elimination System permit issued under the federal Clean Water Act.

**K. "NOI"** means Notice of Intent to be covered by this permit (see Part III of this permit).

**L. "Operator"** means that person or those persons with responsibility for the management and performance of each facility.

**M. "Permittee"** means the person holding a permit issued by the Department.

**N. "Person"** means an individual, receiver, trustee, guardian, personal representative, fiduciary, or representative of any kind, and any partnership, firm, association, corporation, or other entity. Person includes the federal government, this State, any county, municipal corporation or other political subdivision of this State or any of their units.

**O. "Project"** means the total area upon which construction activity will occur through stages or phases over time.

**P. "Section 313 water priority chemical"** means a chemical or chemical categories which: 1) are listed at 40 CFR 372.65 pursuant to Section 313 of Title III of the Superfund Amendments and Reauthorization Act (SARA) of 1986, also titled the Emergency Planning and Community Right-to-Know Act of 1986; 2) are present at or above threshold levels at a facility subject to SARA Title III, Section 313 reporting requirements; and 3) that meet at least one of the following criteria: (i) are listed in Appendix D of 40 CFR 122 on either Table II (organic priority pollutants), Table III (certain metals, cyanides, and phenols) or Table V (certain toxic

pollutants and hazardous substances); (ii) are listed as a hazardous substance pursuant to Section 311(b)(2)(A) of the Clean Water Act at 40 CFR 116.4; or (iii) are pollutants for which EPA has published acute or chronic water quality criteria.

**Q. "Significant materials"** includes, but is not limited to: raw materials; fuels; materials such as solvents, detergents, and plastic pellets; finished materials, such as metallic products; raw materials used in food processing or production; hazardous substances designated under Section 101(14) of CERCLA; any chemical the facility is required to report pursuant to Section 313 of Title III of SARA; fertilizers; pesticides; and waste products, such as ashes, slag and sludge that have the potential to be released with storm water discharges.

**R. "Significant spills"** includes, but is not limited to: releases of oil or hazardous substances in excess of reportable quantities under Section 311 of the Clean Water Act (40 CFR 110.10 and 40 CFR 117.21) or Section 102 of CERCLA (40 CFR 302.4).

**S. "State discharge permit"** means a discharge permit issued pursuant to the Environment Article, Title 9, Subtitle 3, Annotated Code of Maryland.

**T. "Storm water associated with construction activity"** means the discharge from any conveyance which is used for collecting and conveying storm water and which is directly related to clearing, grading, and excavation activities. For this permit, groundwater that seeps into construction excavations shall be considered and regulated as storm water.

**U. "Storm water associated with industrial activity"** means storm water as defined in 40 CFR 122.26(b)(14).

**V. "Surface waters"** means all waters of this State which are not ground waters.

**W. "Wastewater"** means any:

1. Liquid waste substance derived from industrial, commercial, municipal, residential, agricultural, recreational, or other operations or establishments; and

2. Other liquid waste substance containing liquid, gaseous or solid matter and having characteristics which will pollute any waters of this State.

**X. "Waters of this State"** includes:

1. Both surface and underground waters within the boundaries of this State subject to its jurisdiction, including that part of the Atlantic Ocean within the boundaries of this State, the Chesapeake Bay and its tributaries, and all ponds, lakes, rivers, streams, tidal and nontidal wetlands, public ditches, tax ditches, and public drainage systems within this State, other than those designed and used to collect, convey, or dispose of sanitary sewage; and

2. The flood plain of free-flowing waters determined by the Department of the Environment on the basis of the 100-year flood frequency.

***PART III. Notice of Intent Requirements.***

***A. Deadlines for Notification.*** Any person who has an existing individual State or State/NPDES discharge permit for activities covered under this general permit is not obligated to obtain coverage under this general permit until the individual State or State/NPDES discharge permit expires. At least 180 days prior to the expiration date of the individual State or State/NPDES discharge permit for activities covered under this general permit, a person shall submit an NOI requesting coverage under this general permit. However, a person currently covered under an individual State or State/NPDES discharge permit may choose to request coverage under this general permit by submitting an NOI and a fee in accordance with the requirements of this Part following issuance of this general permit. At least 30 days prior to the commencement of any new storm water discharge covered under this general permit, a person shall request coverage by submitting an NOI in accordance with the requirements of this Part. Any person who is covered under 92-GP-0001 shall submit a new NOI and fee within 60 days of issuance to continue coverage. A person planning construction activity (disturbing five or more acres) at an industrial facility must submit an NOI or updated NOI at least 48 hours prior to any land disturbing activities. The Department may bring an enforcement action for failure to submit an NOI in a timely manner, or for any unauthorized discharges that occurred prior to obtaining coverage under this permit.

***B. Notice of Intent.*** A person shall obtain the appropriate NOI form from the Department, and shall provide the following information:

1. County, name and address (location) of the facility;
2. Name and telephone number of the facility contact;
3. Written description of industrial activity taking place;
4. One four-digit SIC code that best represent the principal products or activities provided by the facility;
5. Watershed basin code;
6. The latitude and longitude of the approximate center of the facility to the nearest 15 seconds;
7. The name of the receiving water(s), or if the discharge is to a municipal separate storm sewer, the name of the municipal operator of the storm sewer and the ultimate receiving water(s);
8. Permit number of any other NPDES permit issued for the facility;
9. Area of industrial activity at facility in acres;
10. Status of owner/operator (private, Federal, etc);
11. Federal tax ID number;
12. Name and mailing address of applicant (company that operates the permitted facility);
13. Name and telephone number of operator contact;
14. A summary of all existing quantitative data, if any, describing the concentration of pollutants in storm water discharges;
15. Where construction is involved, a brief project description, including existing and proposed

land uses;

16. Where construction is involved, the total site area, the total proposed disturbed area, the type(s) of storm water management best management practice(s) (BMP) proposed, and the total drainage area to be controlled by each type of BMP; and

17. Signature of applicant.

If a person operates multiple facilities, an NOI is required for each noncontiguous site.

### ***C. Discharge Permit Fee***

Persons who intend to obtain coverage under this general permit shall submit to the Department a fee of \$550 with the NOI application. Local and state governments are not required to pay a fee.

As an alternative to a single fee, a person may submit five annual \$120 payments beginning with the submission of the NOI application and every July 1 thereafter.

For facilities which did not begin operating until after September 29, 1995 and which were previously registered under permit 92-GP-0001, the total fee shall be discounted by 100 dollars for each full calendar year between January 1, 1993 and the month which operations began.

The discharge fee for new facilities that have commenced operating after July 1 of any year shall be prorated on a monthly basis.

### ***D. Required Signatures.***

1. Certification. Any person signing an NOI shall make the following certification as part of the NOI.

"I certify under penalty of law that this document and all attachments were prepared under my direction or supervision in accordance with a system designed to assure that qualified personnel properly gather and evaluate the information submitted. Based on my inquiry of the person or persons who manage the system, or those persons directly responsible for gathering the information, the information submitted is, to the best of my knowledge and belief, true, accurate, and complete. I am aware that there are significant penalties for submitting false information, including the possibility of fine and imprisonment for knowing violations."

2. Signatories. The NOI shall be signed as follows:

a. For a corporation: by a responsible corporate officer. For the purpose of this section, a responsible corporate officer means:

(i) A president, secretary, treasurer, or vice-president of the corporation in charge of a principal business function, or any other person who performs similar policy or decision-making functions for the corporation; or

(ii) The manager of one or more manufacturing, production, or operating facilities employing more than 250 persons or having gross annual sales or expenditures exceeding \$25 million (in second-quarter 1980 dollars), if authority to sign documents has been assigned or delegated to the manager in accordance with corporate procedures.

b. For a partnership or sole proprietorship: by a general partner or the proprietor, respectively; or

c. For a municipal, State, federal, or other public agency: by either a principal executive officer or ranking elected official. For purposes of this section, a principal executive officer of a federal agency includes:

(i) The chief executive officer of the agency; or

(ii) A senior executive officer having responsibility for the overall operations of a principal geographic unit of the agency (e.g., Regional Administrators of EPA).

### 3. Report Submission.

a. All reports required by permits, and other information requested by the Department shall be signed by a person described in Part III E.2 or by a duly authorized representative of that person. A person is a duly authorized representative only if:

(i) The authorization is made in writing by a person described in Part III E.2;

(ii) The authorization specifies either an individual or a position having responsibility for the overall operation of the regulated facility or activity such as the position of plant manager, operator of a well or a well field, superintendent, position of equivalent responsibility or an individual or position having overall responsibility for environmental matters for the company; and



(iii) The written authorization is submitted to the Department.

b. If an authorization under this subsection is no longer accurate because a different individual or position has responsibility for the overall operation of the facility, a new authorization satisfying the requirements of Part III E.3(a) must be submitted to the Department prior to or together with any reports, information or applications to be signed by the new authorized representative.

**E. Where to Submit.** A person shall submit a signed copy of the NOI and the required fee, made payable to the Maryland Department of the Environment, to the following address:

Maryland Department of the Environment  
P.O. Box 2057  
Baltimore MD 21203-2057

**F. Failure to Notify.** Persons who discharge storm water associated with industrial activity, who fail to notify the Department of their intent to be covered under this permit, and who discharge to waters of this State without an individual State or State/NPDES discharge permit, are in violation of the federal Clean Water Act and the Environment Article, Annotated Code of Maryland, and may be subject to penalties.

**G. Additional Notification.**

Facilities which discharge storm water associated with industrial activity to the municipal separate storm sewer system of Anne Arundel County, Baltimore (City), Baltimore County, Carroll County, Charles County, Frederick County, Harford County, Howard County, Montgomery County, Prince George's County, or the State Highways Administration shall, in addition to filing copies of the NOI in accordance with condition III.B., submit, concurrently, signed copies of the NOI to the operator of the municipal separate storm sewer to which they discharge (see NOI form for addresses).

**H. Permit Expiration and Renewal.** Within 60 days after the reissuance of this general permit with new effective and expiration dates, the permittee is required to submit to the Department either:

1. A notice that the discharge or industrial activity (including the exposure of residual pollutants from concluded industrial activity) will cease by the expiration date of this permit; or
2. A new NOI and any fee in accordance with the requirements of the reissued general permit in order to be covered under the reissued general permit.

**Part IV. Special Conditions.**

***A. Releases In Excess Of Reportable Quantities***

1. The discharge of hazardous substances or oil in the storm water discharge(s) from a facility shall be prevented or minimized in accordance with the applicable storm water pollution prevention plan for the facility. This permit does not relieve the permittee of the reporting requirements of 40 CFR part 117 and 40 CFR part 302. Except as provided in condition IV.A.2 (multiple anticipated discharges) of this permit, where a release containing a hazardous substance in an amount equal to or in excess of a reporting quantity established under either 40 CFR 117 or 40 CFR 302, occurs during a 24-hour period:

a. The discharger is required to notify the Department of any oil spill or discharge of oil by calling its Emergency Response Division at (410) 974-3551 and notify the National Response Center (NRC) at (800) 424-8802 or, in the Washington, DC metropolitan area, at (202) 426-2675 in accordance with the requirements of COMAR 26.10.01.03, 40 CFR 117 and 40 CFR 302 respectively as soon as he or she has knowledge of the discharge;

b. The permittee shall submit to the Department within 10 working days of knowledge of the release a written description of: the release (including the type and estimate of the amount of material released), the date that such release occurred, the circumstances leading to the release, and steps to be taken in accordance with condition IV.A.1.c (below) of this permit, and any other information as required by COMAR 26.10.01.03; and

c. The storm water pollution prevention plan required under condition IV.B (storm water pollution prevention plans) of this permit must be modified within 14 calendar days of knowledge of the release to: provide a description of the release, the circumstances leading to the release, and the date of the release. In addition, the plan must be reviewed to identify measures to prevent the reoccurrence of such releases and to respond to such releases, and the plan must be modified where appropriate.

2. Multiple Anticipated Discharges - Facilities which have more than one anticipated discharge per year containing the same hazardous substance in an amount equal to or in excess of a reportable quantity established under either 40 CFR 117 or 40 CFR 302, which occurs during a 24-hour period, where the discharge is caused by events occurring within the scope of the relevant operating system shall comply with conditions IV.A.1.a,b, and c above, but must submit notifications only for the first such release that occurs during a calendar year (or for the first year of this permit, after submittal of an NOI).

3. Spills. This permit does not authorize the discharge of hazardous substances or oil resulting from an on-site spill.

***B. Storm Water Pollution Prevention Plans - General***

The permittee shall develop a storm water pollution prevention plan for each facility covered by this permit. The storm water pollution prevention plan shall be prepared in accordance with sound engineering practices. The plan shall identify potential sources of pollution which may reasonably be expected to affect the quality of storm water discharges associated with industrial activity from the facility. In addition, the plan shall describe and ensure the implementation of practices which are to be used to reduce the pollutants in storm water discharges associated with industrial activity at the facility and to assure compliance with the terms and conditions of this permit.

1. In developing this plan, the permittee shall use as a reference "Storm Water Management for Industrial Activities: Developing Pollution Prevention Plans and Best Management Practices" (EPA Document #EPA832-R-92-006) or, when it is available, an EPA-published summary document on the same subject. These documents can be obtained from the National Technical Information Service, 5285 Port Royal Road, Springfield, Virginia 22161 (phone: 703-487-4600).

2. The plan shall be signed in accordance with Part III, Section E.2 of this permit, and be retained on site in accordance with Part VI, Section A.2 of this permit. Plans for facilities in existence at the time of the issuance of this permit shall be completed within one year of obtaining coverage under this general permit or within one year of notification by the Department of the need for obtaining a storm water discharge permit, whichever occurs first. Plans shall provide for compliance with the terms of the plan within 18 months of obtaining coverage under this general permit or within 18 months of notification by the Department of the need for obtaining a storm water discharge permit, whichever occurs first. In the case of new facilities, the plan shall be completed and implemented prior to submitting an NOI to be covered under this permit. The permittee shall make plans available upon request to the Department, and in the case of a storm water discharge associated with industrial activity which discharges to a municipal separate storm sewer system with an NPDES permit, to the municipal operator of the system (those systems are listed in Condition III. G, addresses are on NOI).

3. If the plan is reviewed by the Department, the Department may notify the permittee, at any time, that the plan does not meet one or more of the minimum requirements of this Part. After such notification from the Department, the permittee shall make changes to the plan to meet the objections of the Department and shall submit to the Department a written certification that the requested changes have been made and implemented. Unless otherwise provided by the Department, the permittee shall have 90 days after such notification to make the necessary changes.

4. The permittee shall amend the plan whenever there is a change in design, construction, operation, or maintenance which has a significant effect on the potential for the discharge of pollutants to the waters of the State or if the storm water pollution prevention plan proves to be ineffective in achieving the general objectives of controlling pollutants in storm water discharges associated with industrial activity. Amendments to the plan may be reviewed by the Department as described above.

***C. Storm Water Pollution Prevention Plan - Contents***

The plan shall include, at a minimum, the following items:

1. **Description of Potential Pollutant Sources**

Each plan shall provide a description of potential sources which may be reasonably expected to add significant amounts of pollutants to storm water discharges. Each plan shall identify all activities and significant materials which may potentially be significant pollutant sources. Each plan shall include:

a. A site map indicating an outline of the drainage area of each storm water outfall; each existing structural control measure to reduce pollutants in storm water runoff; and surface water bodies, including drainage ditches and wetlands.

b. A topographic map (or other map, if a topographic map is unavailable), extending one-quarter of a mile beyond the property boundaries of the facility. The requirements of this condition may be included in the site map required under Part IV, Section C.1.a. above, if appropriate.

c. A narrative description of significant materials that have been treated, stored, or disposed in a manner which allowed exposure to storm water at anytime from three years prior to obtaining coverage under this permit until the time the present method of on-site storage or disposal was initiated; materials management practices employed to minimize contact of these materials with storm water runoff; materials loading and access areas; the location and a description of existing structural and non-structural control measures to reduce pollutants in storm water runoff; and a description of any treatment the storm water receives.

d. For each area of the facility that generates storm water discharges associated with industrial activity with a reasonable potential for containing significant amounts of pollutants, a prediction of the direction of flow, and an estimate of the types of pollutants which are likely to be present in storm water discharges associated with industrial activity; and

e. A summary of all existing sampling data describing pollutants in storm water discharges.

2. **Storm Water Management Controls**

Each facility covered by this permit shall develop a description of storm water management controls appropriate for the facility, and implement such controls. The appropriateness and priorities of controls in a plan shall reflect identified potential sources of pollutants at the facility. The description of storm water management controls shall address the following minimum components, including a schedule for implementing such controls:

a. **Preventive Maintenance.** A preventive maintenance program that involves timely inspection and maintenance of storm water management devices (cleaning oil/water separators, catch basins) as well as inspecting and testing plant equipment and systems to uncover conditions that could cause breakdowns or failures resulting in discharges of pollutants to surface waters.

b. **Good Housekeeping.** Good housekeeping that requires the maintenance of a clean, orderly facility.

c. **Spill Prevention and Response Procedures.** If spills have a potential to occur, procedures for cleaning up spills shall be identified in the plan and made known to the appropriate personnel. The necessary equipment to implement a cleanup shall be available to the appropriate personnel.

d. **Sediment and Erosion Prevention.** The plan shall identify areas which, due to topography, activities, or other factors, have a high potential for significant soil erosion, and identify measures to limit erosion.

e. **Management of Runoff.** The plan shall contain a narrative consideration of the appropriateness of traditional storm water management practices (practices other than those which control the generation or source(s) of pollutants) used to divert, infiltrate, reuse, or otherwise manage storm water runoff in a manner that reduces pollutants in storm water discharges from the site. The plan shall provide that measures determined to be reasonable and appropriate shall be implemented and maintained. The potential of various sources at the facility to contribute pollutants to storm water discharges associated with industrial activity (see Part IV, Section C.1. - description of potential pollutant sources) shall be considered when determining reasonable and appropriate measures. Appropriate measures may include: vegetative swales and practices, reuse of collected storm water (such as for a process or as an irrigation source), inlet controls (such as oil/water separators), snow management activities, infiltration devices, and wet detention/retention devices.

f. **Visual Inspections.** Qualified plant personnel shall be identified to inspect designated equipment and plant areas. A site inspection shall be conducted annually by such personnel to verify that the description of potential pollutant sources required under Part IV, Section C.1. is accurate, the drainage map has been updated to reflect current conditions, and the controls to reduce pollutants identified in the storm water pollution prevention plan are being implemented and are adequate. In particular, material handling areas shall be inspected for

evidence of, or the potential for, pollutants entering the drainage system. A tracking or follow-up procedure shall be used to ensure that each inspection results in an appropriate response.

g. **Recordkeeping and Internal Reporting Procedures.** Spills or other discharge incidents, and information describing the quality and quantity of storm water discharges shall be in the facility records. Maintenance activities shall be documented and recorded with inspection and discharge records. All records shall be maintained at the facility, for a minimum of three years. This period shall be automatically extended during the course of litigation, or when requested by the Department.

3. **Consistency with Other Plans**

Storm water management programs may include requirements for Spill Prevention Control and Countermeasure (SPCC) plans under Section 311 of the Clean Water Act or Best Management Practices (BMPs) programs otherwise required by an NPDES permit and may incorporate any part of such plans into the storm water pollution prevention plan by reference.

4. **Special Requirements for Storm Water Discharges Associated with Industrial Activity to Municipal Separate Storm Sewer Systems Serving a Population of 100,000 or More**

Facilities covered by this permit shall comply with applicable requirements in municipal storm water management programs developed under State/NPDES permits issued for the discharge of the municipal separate storm sewer system that receives the facility's discharge, provided the municipal operator has notified the discharger of such conditions. These facilities shall make storm water pollution prevention plans available to the municipal operator of the system upon request.

5. **Salt Storage**

Storage piles of salt used for deicing or other commercial or industrial purposes shall be enclosed or covered to prevent exposure to precipitation.

6. **Pollution Prevention Committee**

The description of the storm water Pollution Prevention Committee shall identify specific individuals within the plant organization who are responsible for developing the storm water pollution prevention plan and assisting the plant manager in its implementation, maintenance, and revision. The activities and responsibilities of the committee should address all aspects of the facility's storm water pollution prevention plan.

7. **Employee Training**

Employee training programs shall inform personnel at all levels of responsibility of the components and goals of the storm water pollution prevention plan. Training should address topics, such as spill response, good housekeeping and material management practices. A pollution prevention plan shall identify periodic dates for such training.

***D. STORM WATER POLLUTION PREVENTION PLAN - ADDITIONAL REQUIREMENTS FOR FACILITIES SUBJECT TO SARA TITLE III, Section 313 REQUIREMENTS***

Storm water pollution prevention plans for facilities subject to reporting requirements under SARA Title III, Section 313 (42 U.S.C. §11023) are required to include, in addition to the information listed in Part IV, Section C., a discussion of the facility's conformance with the following (appropriate) guidelines:

1. In areas where Section 313 water priority chemicals are stored, processed or otherwise handled, appropriate containment, drainage control and/or diversionary structures shall be provided. At a minimum, one of the following preventive systems or its equivalent shall be used:

a. Curbing, culverting, gutters, sewers or other forms of drainage control to prevent or minimize the potential for storm water runoff to come into contact with significant sources of pollutants; or

b. Roofs, covers, liners, or other forms of appropriate protection to prevent storage piles from leaching or exposure to storm water and wind.

2. The storm water pollution prevention plan shall include a complete discussion of measures taken to conform with the following applicable guidelines, other effective storm water pollution prevention procedures, and applicable State rules, regulations and guidelines.

a. **Liquid storage areas where storm water comes into contact with any equipment, tank, container, or other vessel used for Section 313 water priority chemicals.** No tank or container shall be used for the storage of a Section 313 water priority chemical unless its material and construction are compatible with the material stored and conditions of storage, such as pressure and temperature, etc. Liquid storage areas for Section 313 water priority chemicals shall be operated to minimize discharges of Section 313 chemicals by means such as secondary containment for at least the entire contents of the largest single tank plus sufficient freeboard to allow for precipitation, a strong spill contingency and integrity testing plan, and/or other equivalent measures.

b. **Truck and rail car loading and unloading areas for liquid Section 313 water priority chemicals.** These areas shall be operated to minimize discharges of Section 313 water priority chemicals by means such as the placement and maintenance of drip pans (including the proper disposal of materials collected in the drip pans) where spillage may occur (such as hose connections, hose reels and filler nozzles) for use when making and breaking hose connections; a strong spill contingency and integrity testing plan; and/or other equivalent measures.

c. **In plant areas where Section 313 water priority chemicals are transferred, processed or otherwise handled.** Piping, processing equipment and materials handling equipment shall be designed and operated so as to prevent discharges of Section 313 chemicals, and be composed of materials that are compatible with the substances handled. Additional protection,



such as covers or guards to prevent wind blowing, spraying or releases from pressure relief vents from causing a discharge of Section 313 water priority chemicals to the drainage system shall be provided, as appropriate, to control the releases.

d. **Discharges from secondary containment areas.**

(1) Drainage from secondary containment shall be restrained by valves or other positive means to prevent a spill or other excessive leakage of Section 313 water priority chemicals into the drainage system. After a visual inspection of the storm water and determination that no product is present, containment areas may be emptied by pumps or ejectors; however, these shall be manually activated.

(2) Flapper-type drain valves shall not be used to drain containment areas. Valves used for the drainage of containment areas shall be of manual, open-and-close design.

(3) Records of the frequency and estimated volume (in gallons) of discharges from containment areas shall be kept at the facility for a minimum of three years.

(4) In lieu of facility drainage engineered as described above, the final discharge of all in-facility storm sewers shall be equipped with a diversion system that could, in the event of an uncontrolled spill of Section 313 water priority chemicals, return the spilled material to the facility.

(5) **Facility site runoff other than from areas covered by (a), (b), (c) or (d).** Other areas of the facility [those not addressed in paragraphs (a), (b), (c) or (d)], from which runoff which may contain Section 313 water priority chemicals or spills of Section 313 water priority chemicals and which could cause a discharge shall incorporate the necessary drainage or other control features to prevent discharge of spilled or improperly disposed material and ensure the mitigation of pollutants in runoff or leachate.

3. **Facility Security**

Facilities shall have the necessary security systems to prevent accidental or intentional entry which could cause a discharge. Security systems shall be described in the plan and address fencing, lighting, vehicular traffic control, and securing of equipment and buildings.

4. **Risk Identification and Assessment/Material Inventory**

The storm water pollution prevention plan shall assess the potential of various sources at the plant to contribute pollutants to storm water discharges associated with industrial activity. The plan shall include an inventory of the types of materials handled. Facilities shall include in the plan a description of releases to land or water of SARA Title III water priority chemicals that have occurred at any time after July 1, 1989. Each of the following shall be evaluated for the reasonable potential for contributing pollutants to runoff: loading and unloading operations; outdoor storage activities; outdoor manufacturing or processing activities; significant dust or particulate generating

processes; and on-site waste disposal practices. Factors to consider include the toxicity of chemicals; quantity of chemicals used, produced, or discharged; the likelihood of contact with storm water; and history of significant leaks or spills of toxic or hazardous pollutants.

***E. STORM WATER POLLUTION PREVENTION PLAN - ADDITIONAL REQUIREMENTS FOR CONSTRUCTION ACTIVITY***

1. **Plans and Approvals**

Prior to commencing construction, the permittee shall obtain approved erosion and sediment control plans in accordance with the requirements established in Title 4, Subtitle 1 of the Environment Article, Annotated Code of Maryland (Sediment Control); and in Code of Maryland Regulations (COMAR) 26.09.01 (Erosion and Sediment Control); and shall obtain approved storm water management plans in accordance with the requirements established in Title 4, Subtitle 2 of the Environment Article, Annotated Code of Maryland (Storm Water Management); and in COMAR 26.09.02 (Storm Water Management).

2. **Monitoring and Records**

For the purposes of monitoring, permittees must do all of the following:

- a. During construction, maintain at the site the approved erosion and sediment control plan.
- b. Conduct the following inspections:
  - (1) weekly inspections of implemented erosion and sediment controls; and
  - (2) inspections of erosion and sediment controls the next business day after a rainfall event resulting in runoff.
- c. During construction, maintain at the site written reports of all inspections conducted by the permittee that include:
  - (1) the date and time of the inspection;
  - (2) the name(s) of the individual(s) who performed the inspection;
  - (3) an assessment of the condition of erosion and sediment controls;
  - (4) a description of any erosion and sediment control implementation and maintenance performed; and
  - (5) a description of the site's present phase of construction.
- d. Maintain all inspection reports and enforcement actions issued to the permittee by the appropriate enforcement authority.
- e. Permittees must retain the records described in Part IV. E. 2. a., c., and d. and records of all data used to complete the NOI to be covered by this permit for a period of three (3) years from the date that the site is finally stabilized.

3. Duty to Comply With Plans

It is a condition of this permit that the permittee comply with erosion and sediment control and storm water management plans approved in accordance with the laws and regulations cited in Part IV. E. 1 above, and with all conditions of this general permit

4. Continuation of Coverage Under This Permit

Once construction has commenced, it is a condition of this permit that erosion and sediment control and storm water management plan approvals be kept in effect. Construction activity may not continue if these plans have expired, but may resume once plans are renewed without payment of an additional fee.

***V. Violation of Permit Conditions.***

***A. Compliance With This General Permit and Water Pollution Abatement Statutes.*** The permittee shall comply at all times with the terms and conditions of this permit, the provisions of the Title 7, Subtitle 2, Title 9, Subtitles 2 and 3 of the Environment Article, Annotated Code of Maryland, and the Federal Act.

***B. Civil and Criminal Liability.*** In issuing or reissuing this permit, the Department does not waive or surrender any right to proceed in an administrative, civil, or criminal action for any violations of State law or regulations occurring before the issuance or reissuance of this permit. Nothing in this permit shall be construed to preclude the institution of any legal action or relieve the permittee from any civil or criminal responsibilities, liabilities, or penalties for noncompliance with Title 9 of the Environment Article, Annotated Code of Maryland or any federal, local or other state law or regulation.

***C. Civil Penalties for Violations of Permit Conditions.*** In addition to civil penalties for violations of State water pollution control laws set forth in Section 9-342 of the Environment Article, Annotated Code of Maryland, the Federal Act provides that any person who violates Section 301, 302, 306, 307, 308, 318, or 405 of the Act, or any permit condition or limitation implementing any of such sections in a permit issued under Section 402 of the Act or in a permit issued under Section 404 of the Act, is subject to a civil penalty not to exceed \$25,000 per day for each violation.

***D. Criminal Penalties for Violations of Permit Conditions.*** In addition to criminal penalties for violations of State water pollution control laws set forth in Section 9-343 of the Environment Article, Annotated Code of Maryland, the Federal Act provides that:

1. Any person who negligently violates Section 301, 302, 306, 307, 308, 318, or 405 of the Act, or any permit condition or limitation implementing any of such sections in a permit issued under Section 402 of the Act, or in a permit issued under Section 404 of the Act, is subject to a fine

of not less than \$2,500 nor more than \$25,000 per day of violation, or by imprisonment for not more than one (1) year, or by both.

2. Any person who knowingly violates Section 301, 302, 306, 307, 308, 318, or 405 of the Act, or any permit condition or limitation implementing any of such sections in a permit issued under Section 402 of the Act, or in a permit issued under Section 404 of the Act, is subject to a fine of not less than \$5,000 nor more than \$50,000 per day of violation, or by imprisonment for not more than three (3) years, or by both.

3. Any person who knowingly violates Section 301, 302, 306, 307, 308, 318, or 405 of the Act, or any permit condition or limitation implementing any of such sections in a permit issued under Section 402 of the Act, or in a permit issued under Section 404 of the Act, and who knows at that time that he thereby places another person in imminent danger of death or serious bodily injury, is subject to a fine of not more than \$250,000 or imprisonment of not more than fifteen (15) years, or both. A person which is a corporation, shall, upon conviction, be subject to a penalty of not more than \$1,000,000.

***E. Penalties for Falsification and Tampering.*** The Environment Article, §9-343, Annotated Code of Maryland provides that any person who knowingly makes any false material statement, representation, or certification in any application, record, report, plan, or other document filed or required to be maintained under this permit, including monitoring reports or reports of compliance or noncompliance, or who knowingly falsifies, tampers with or renders inaccurate any monitoring device or method required to be maintained under this permit shall, upon conviction, be punished by a fine of not more than \$10,000 per violation, or by imprisonment for not more than 6 months per violation, or by both. The federal Clean Water Act provides that any person who knowingly falsifies, tampers with, or renders inaccurate any monitoring device or method required to be maintained under the Act, or who knowingly makes any false statement, representation, or certification in any records or other documents submitted or required to be maintained under this permit, including monitoring reports or reports of compliance or noncompliance shall, upon conviction, be punished by a fine of not more than \$10,000, or by imprisonment for not more than two years, or by both.

**Part VI. General Conditions.**

**A. Right of Entry.** The permittee shall permit the Secretary of the Department, the Regional Administrator for the EPA, or their authorized representatives, upon the presentation of credentials:

1. To enter upon the permittee's premises where an effluent source is located or where any records are required to be kept under the terms and conditions of this permit;
2. To access and copy, at reasonable times, any records required to be kept under the terms and conditions of this permit;
3. To inspect, at reasonable times, any monitoring equipment or monitoring method required in this permit;
4. To inspect, at reasonable times, any collection, treatment, pollution management, or discharge facilities required under this permit;
5. To sample, at reasonable times, any discharge of pollutants;
6. To install ground water monitoring wells; and
7. To take photographs.

**B. Property Rights/Compliance with Other Requirements.** The issuance of this permit does not convey any property rights in either real or personal property, or any exclusive privileges, nor does it authorize any injury to private property or any invasion of personal rights, nor does it authorize any infringement of federal, State or local laws or regulations.

**C. Duty to Provide Information.** The permittee shall furnish to the Department, within the time frame stipulated by the Department, any information which the Department may request to determine compliance with this permit. The permittee shall also furnish to the Department, upon request, copies of records required to be kept by this permit.

**D. Other Information.** If the permittee becomes aware that incorrect information has been included in the NOI or any other report submitted to the Department, or relevant facts have been omitted from the NOI or any other report to the Department, the permittee shall submit the correct information or facts to the Department with 30 calendar days of becoming aware.

**E. Availability of Reports.** Except for data determined to be confidential under the Maryland Public Information Act, and Section 308 of the federal Clean Water Act, all submitted data shall be available for public inspection at the Department.

**F. Toxic Pollutants.** The permittee shall comply with effluent standards or prohibitions for toxic pollutants established under the federal Clean Water Act, or under Section 9-314 and Sections 9-

322 through 9-328 of the Environment Article, Annotated Code of Maryland. Compliance shall be achieved within the time provided in the regulations that establish these standards or prohibitions, even if this permit has not yet been modified to incorporate the requirement.

***G. Oil and Hazardous Substances Prohibited.*** Nothing in this permit shall be construed to preclude the institution of any legal action or relieve the permittee from any responsibility, liability, or penalties to which the permittee may be subject under the federal Clean Water Act or under the Annotated Code of Maryland.

***H. Water Construction and Obstruction.*** This permit does not authorize the construction or placing of physical structures, facilities, or debris or the undertaking of related activities in any waters of the State.

***I. Severability.*** The provisions of this permit are severable. If any provisions of this permit shall be held invalid for any reason, the remaining provisions shall remain in full force and effect. If the application of any provision of this permit to any circumstances is held invalid, its application to other circumstances shall not be affected.

***Part VII. Authority to Issue General NPDES Permits.***

On September 5, 1974, the Administrator of the EPA approved the proposal submitted by the State of Maryland for the operation of a permit program for discharges into navigable waters under Section 402 of the federal Clean Water Act, 33 U.S.C. Section 1342.

On September 30, 1990, the Administrator of the EPA approved the proposal submitted by the State of Maryland for the operation of a general permit program.

Under the approvals described above, this general discharge permit is both a State of Maryland general discharge permit and an NPDES general discharge permit.

J. L. Hearn, Director  
Water Management Administration

**Appendix  
D.7**

**MDE/WMA Overview of the NPDES  
Stormwater Program**

## **Background**

The United States Environmental Protection Agency (EPA) issued final regulations in November 1990 that require National Pollutant Discharge Elimination System (NPDES) Permits for stormwater discharges associated with industrial activity. These regulations require permits for stormwater discharges associated with eleven categories of industrial activities and municipal separate storm sewer systems. Within the Maryland Department of the Environment (MDE), these permits are being administered by the Water Management Administration (WMA). Ten of these industrial activities are being permitted by one general permit, the General Industrial Discharge Permit, implemented by WMA's Wastewater Discharge Permit Program. However, industry-specific general permits are currently being drafted.

Examples of these activities are hazardous waste treatment facilities; landfills; open dumps receiving industrial waste; steam electric power generating facilities; mass transit, school bus, and trucking facilities; hazardous waste storage facilities; land application sites; recycling facilities (junk yards, etc.); vehicle maintenance facilities; and treatment works for domestic sewage. The eleventh industrial activity subject to the stormwater discharge permit requirements is construction activity with a planned total disturbance of five acres\* or more. Construction activity, along with municipal separate storm sewer systems, are permitted by MDE/WMA's Compliance Program. Construction activity is being permitted by a general permit that covers only construction, the General Permit for Construction Activity. \* **Area of disturbance subject to NPDES regulatory changes.**

## **Regulatory Requirements for Construction Activity in Maryland**

EPA's regulations [40 CFR (Code of Federal Regulations) 122.26] provide for three types of applications for industrial stormwater discharge permits: an individual application, a group application, and a Notice of Intent (NOI) to comply with a general permit. 40 CFR 122.26(b)(14) identifies construction activity, including clearing, grading, and excavating, as one of the categories of "industrial activity." 40 CFR 122.26(c)(1)(ii) requires that the following information be provided on the NPDES permit application for construction activity:

- (A) The location and the nature of the construction;
- (B) The total area of the site;
- (C) Proposed measures, including best management practices, to control pollutants in stormwater discharges during construction;
- (D) Proposed measures to control pollutants in stormwater discharges that will occur after construction has been completed;
- (E) An estimate of the runoff coefficient of the site and the increase in impervious area after construction; and
- (F) The name of the receiving water.

Because Maryland presently has programs in place to control erosion, sediment and stormwater for new development activities, MDE/WMA has composed its NPDES General Permit in such a way



## Appendix D.7. MDE/WMA Overview of the NPDES Stormwater Program

---

so as not to change current erosion and sediment control and stormwater management requirements.

Through the review and approval and subsequent inspection and enforcement processes for erosion and sediment control and stormwater management, the majority of information required to be submitted under 40 CFR 122.26(c)(1)(ii) will have already been supplied to agencies responsible for construction site evaluation according to Maryland's current laws and regulations (Environment Article Title 4. Subtitle 1; Subtitle 2; COMAR 26.17.01; and COMAR 26.17.02). For this reason, MDE/WMA Simply, operators of construction activity will be complying with 40 CFR 122.26 if they comply with current Maryland law.

### **The General Permit**

Construction activity in Maryland with a planned total disturbance of five acres\* or more will be required to be covered by the General Permit for Construction Activity. Coverage under this Permit mandates that the permittee be held accountable for complying with the terms of the General Permit. Compliance with the terms of the General Permit shall be in compliance with EPA's stormwater regulations.

While Maryland law requires erosion and sediment control and stormwater management plan approval prior to the commencement of construction for any earth disturbance of 5,000 square feet or more, General Permit coverage will be required only for construction activity with a planned total disturbance of five acres\* or more. Plans must still be approved and remain active during the construction phase, as per existing Maryland law.

Permittees are encouraged to submit only one NOI for the entire project, even if plans are not approved for subsequent phases/stages of development. The completed NOI form is considered an application for coverage under the General Permit. The NOI is to be completed by the permittee and will require that general information describing the construction activity be provided. The completed NOI form must be submitted at least 48 hours prior to any earth disturbing activity and the appropriate application fee must accompany the submitted NOI.

### **Who Is Covered by the General Permit?**

It is intended that the General Permit cover construction activity in Maryland with a planned total disturbance of five acres\* or more. This includes phased/staged construction projects, even if individual phases will disturb less than five acres. Current Maryland law requiring approved erosion and sediment control and stormwater management plans for earth disturbances exceeding 5,000 square feet remains unchanged.

The permittee who applies for coverage under the terms of the General Permit shall be held accountable for complying with all of the terms of the General Permit. A person who has submitted

a Notice of Intent (NOI) and does not intend to be responsible for controlling the permitted activities on site must transfer authorization under the General Permit to a duly authorized person.

## Appendix D.7. MDE/WMA Overview of the NPDES Stormwater Program

---

Upon transfer, this duly authorized person shall be held accountable for compliance under the terms stated in the General Permit.

### **How is Coverage Obtained?**

Coverage under the General Permit is obtained by filing a completed Notice of Intent (NOI) form with the Maryland Department of the Environment, Water Management Administration (MDE/WMA). The completed NOI form is considered a formal application for coverage and intent to comply with the terms of the General Permit.

### **What is the Procedure for Application?**

For construction activity with a planned total disturbance of five acres\* or more, General Permit coverage is required. NOI forms are available at local plan review offices and at MDE. NOI forms must be complete and include the signature of the permittee in order to be processed. Completed NOI forms must be submitted with the appropriate application fee (see below) to the Maryland Department of the Environment, Water Management Administration, P.O. Box 1417, Baltimore, Maryland 21203-1417. Receipt by MDE/WMA of the completed NOI form will authorize coverage under the terms of the General Permit. Upon receipt of the completed NOI form, MDE will mail a verification letter and a copy of the General Permit to the permittee. Once the construction activity is completed, including final stabilization and the elimination of all stormwater discharges authorized by the General Permit, the permittee must submit a Notice of Termination form to MDE/WMA. Forms are available at local plan review offices and at MDE.

The application fee schedule for stormwater discharges associated with construction activity is as follows:

<u>Total Disturbed Area (acres)</u>	<u>NOI Fee (dollars)</u>
less than 5	Exempt
5 to less than 10	\$100
10 to less than 15	\$500
15 to less than 20	\$1,500
20 and up	\$2,500

### **What Information is Required on the NOI Form?**

Information required on the NOI Form is general information describing the construction activity. Much of this information can be provided directly by the permittee from prepared site plans and any other necessary information should be available at the local plan review offices. The component parts of the NOI form are outlined below:

- I. Site Name and Location including name and general location of the site; MD Grid Coordinates; latitude and longitude; watershed basin code;
- II. Project Description including stormwater management BMPs to be implemented and drainage area for each type of BMP; brief project description; total site area/disturbed area; runoff curve numbers; estimate of total impervious surface area; the project types, as a county/municipal or private entity and its eventual use as residential, commercial or industrial; Standard Industrial Classification (SIC) code; any other NPDES permit number; name of eventual receiving waters/ storm sewer system receiving the site's runoff;
- III. Permittee Identification including name/company and address of permittee and name and phone number of the principal contact person for the site;
- IV. Certification including a certification statement to be signed by the permittee;
- V. Fees including the fee amount to be paid with the NOI submission.

MDE issued a new Notices of Intent form for use beginning in 1994. This form is a scanner compatible "bubble" form, replacing the original single page handwritten form. This form is the one currently being accepted by MDE and it is available at local plan review offices and at MDE.

Additionally, MDE has developed a new State and Federal NOI form, to be used for all state and federal construction projects. This is a separate NOI form, labeled "For State and Federal Government Project Only," but it is not significantly different from the standard NOI form.

### **When Must the NOI Form be Submitted?**

The completed NOI must be submitted to the Water Management Administration at least 48 hours prior to the commencement of construction activities. This is applicable to all construction activity with a planned total disturbance of five acres\* or more that is active as of October 1, 1992 and any such construction activity beginning on or after October 1, 1992. Such construction will need to be permitted under the General Permit. The application fee is due at the time of NOI submission. Checks and money orders only will be accepted and should be made payable to MDE.

## Appendix D.7. MDE/WMA Overview of the NPDES Stormwater Program

---

MDE has supplied local plan review offices with NOI forms. Forms and information may also be obtained at MDE. It is the responsibility of the permittee to accurately complete the form and submit it to MDE/WMA.

### **Miscellaneous**

Coverage under the General Permit is effective until MDE is notified by the permittee that construction is complete. Submission of a Notice of Termination form to MDE will indicate that construction activity is complete, areas are stabilized, and authorized stormwater discharges have been eliminated (the address is given at the end of the Appendix).

No effluent limitations have been established for stormwater discharges from construction sites. However, the General Permit requires Permittees to visually inspect erosion and sediment controls on a weekly basis and the next work day after a storm event. Permittees are required to maintain, on site during construction, written documentation of the findings and any subsequent maintenance that is performed. These records must be kept for a period of three years following final stabilization of the site and must be made available upon request.

The permittee shall be held accountable for compliance under the term of the General Permit. A person who has submitted an NOI and does not intend to control the permitted activities on the site must transfer authorization under the General Permit to a duly authorized person. Upon transfer, the duly authorized person shall be held accountable for compliance under the terms stated in the General Permit.

Although coverage under the General Permit does not involve additional regulations, it should be noted that because construction activity now falls under the Clean Water Act (CWA), federal penalties will apply to violations. Both state and federal civil and criminal penalties will apply to violations occurring under General Permit coverage.

Further information regarding the General Permit and the NOI form can be obtained by contacting:

The Maryland Department of the Environment  
Water Management Administration  
Compliance Program  
2500 Broening Highway  
Baltimore, Maryland 21224  
(410) 631-3510

**Appendix**

**D.8**

**Miscellaneous Details for Compliance with  
Performance Criteria**

## **Appendix D.8 .....Miscellaneous Details for Compliance with Performance Criteria**

---

Detail 1: Trash Rack for Low Flow Orifice

Detail 2: Expanded Trash Rack Protection for Low Flow Orifice

Detail 3: Internal Control for Orifice Protection

Detail 4: Observation Well for Infiltration Practices

Detail 5: Off-line Versus On-line Schematic

Detail 6: Isolation/Diversion Structure

Detail 7: Half Round CMP Hood

Detail 8: Half Round CMP Weir

Detail 9: Concrete Level Spreader

**Detail 1** Trash Rack Protection for Low Flow Orifice

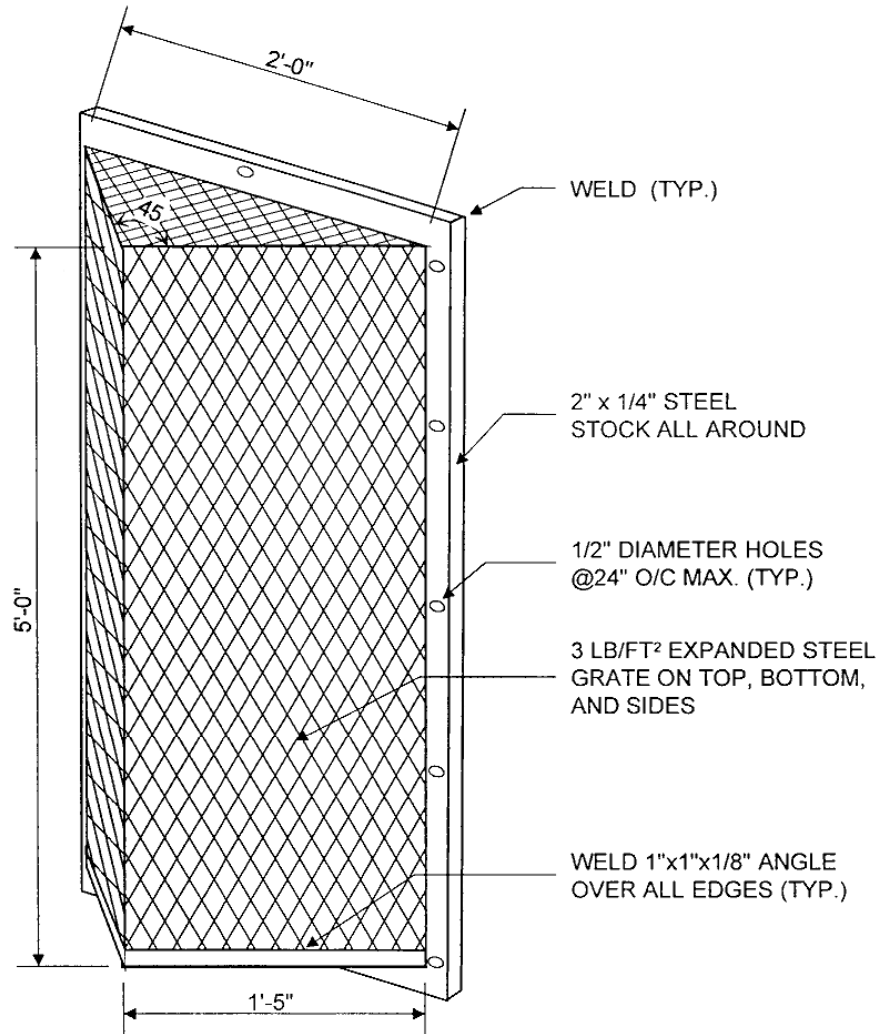

**NOTES FOR TRASH RACK**

1. TRASH RACK TO BE CENTERED OVER OPENING.
2. STEEL TO CONFORM TO ASTM A-36.
3. ALL SURFACES TO BE COATED WITH ZRC COLD GALVANIZING COMPOUND AFTER WELDING.
4. TRASH RACK TO BE FASTENED TO THE WALL WITH 1/2" MASONRY ANCHORS. TRASH RACK TO BE REMOVABLE.

**TRASH RACK DETAIL (NTS)**

**Detail 2** Expanded Trash Rack Protection for Low Flow Orifice

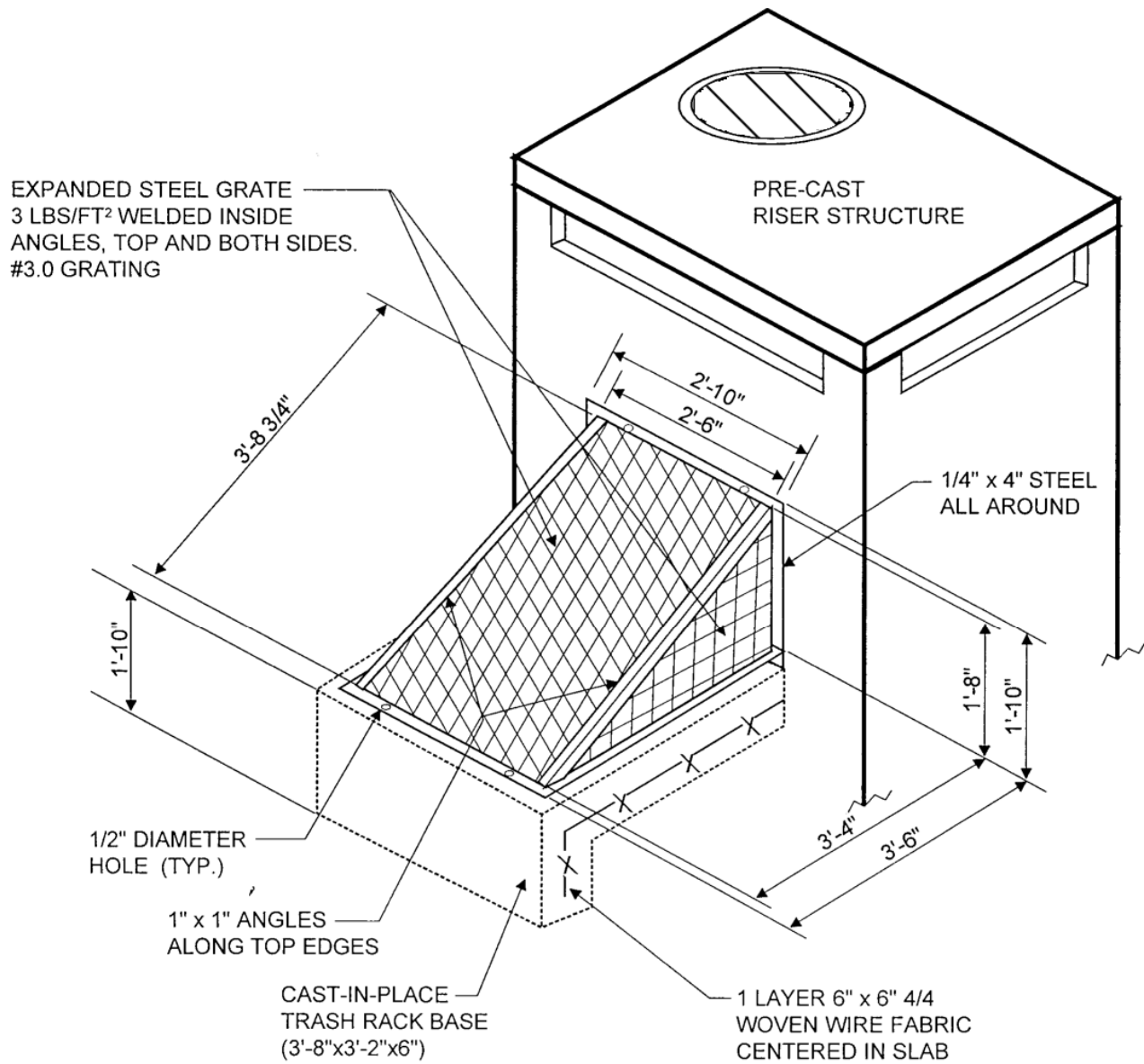

**EXPANDED METAL TRASH RACK (NTS)**



**Detail 3** Internal Control for Orifice Protection

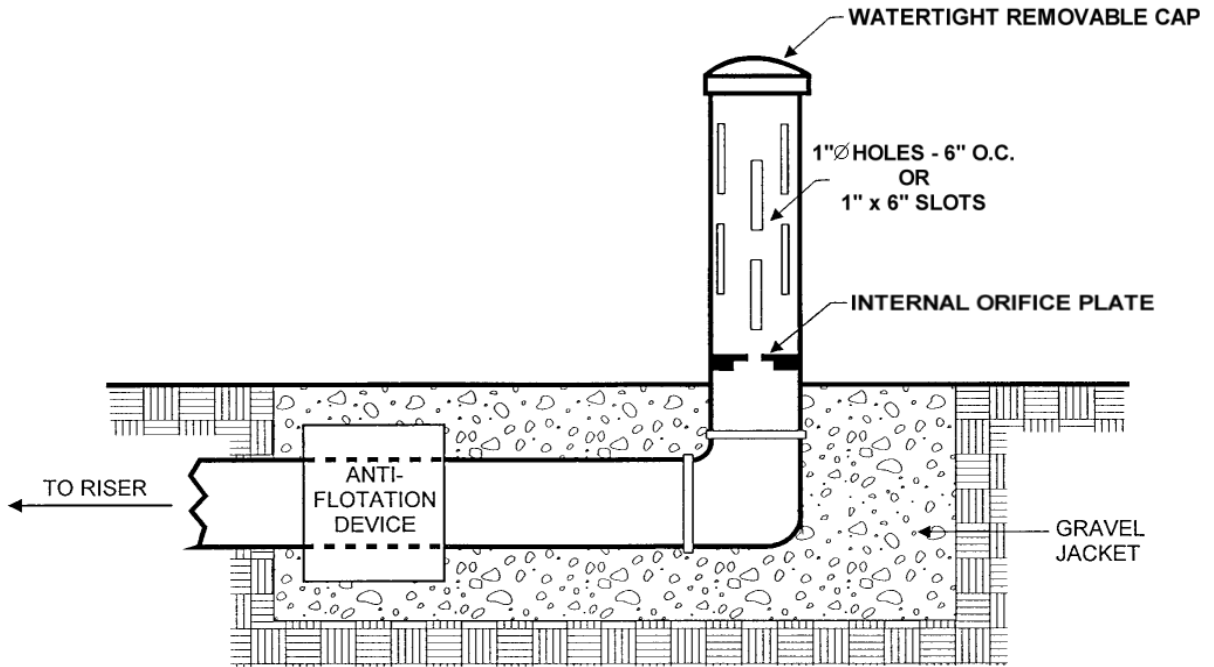

**INTERNALLY CONTROLLED ORIFICE (NTS)**

**Detail 4** Observation Well for Infiltration Practices

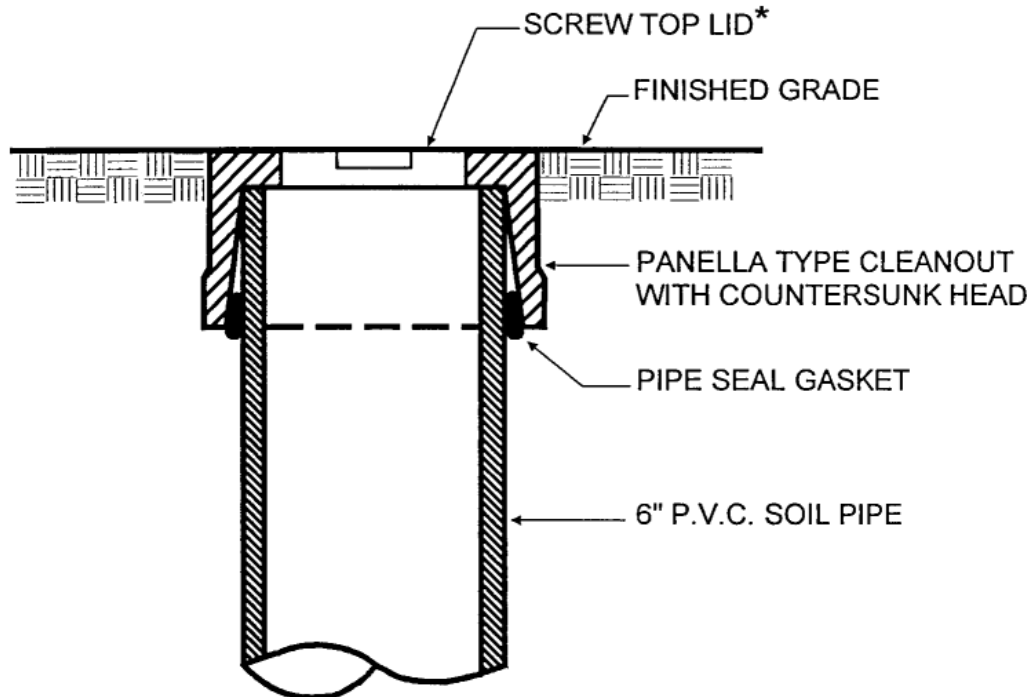

\* ABOVE DETAIL PROVIDED AS SCHEMATIC  
SCREW TOP P.V.C. WELL CAP ONLY

EACH OBSERVATION WELL / CLEANOUT SHALL INCLUDE THE FOLLOWING:

1. FOR AN UNDERGROUND FLUSH MOUNTED OBSERVATION WELL / CLEANOUT, PROVIDE A TUBE MADE OF NON-CORROSIVE MATERIAL, SCHEDULE 40 OR EQUAL, AT LEAST THREE FEET LONG WITH AN INSIDE DIAMETER OF AT LEAST 6 INCHES.
2. THE TUBE SHALL HAVE A FACTORY ATTACHED CAST IRON OR HIGH IMPACT PLASTIC COLLAR WITH RIBS TO PREVENT ROTATION WHEN REMOVING SCREW TOP LID. THE SCREW TOP LID SHALL BE CAST IRON OR HIGH IMPACT PLASTIC THAT WILL WITHSTAND ULTRA-VIOLET RAYS.

**OBSERVATION WELL DETAIL**

**Detail 5 Off-Line Versus On-Line Schematic**

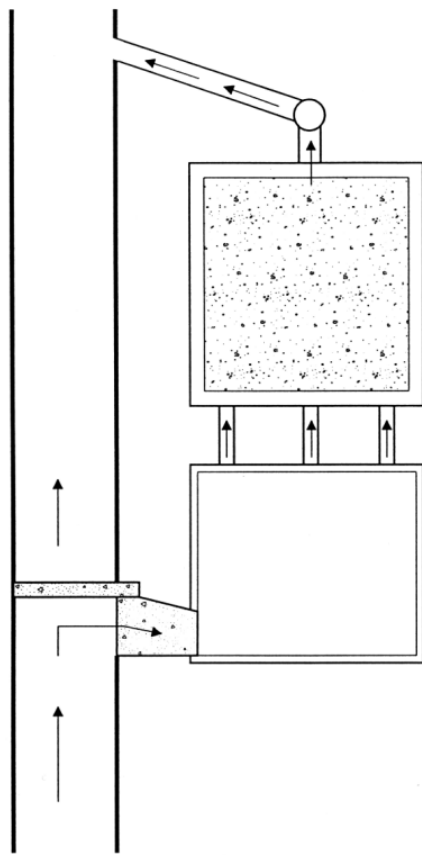

PLAN VIEW

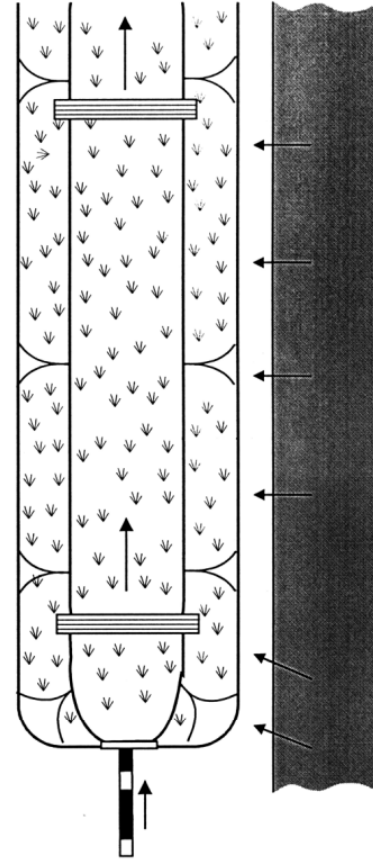

PLAN VIEW

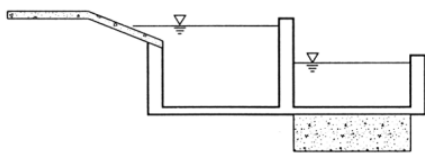

SECTION

**OFF-LINE  
FILTERING SYSTEM**

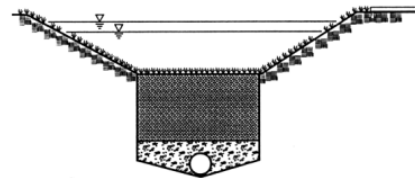

SECTION

**ON-LINE  
FILTERING SYSTEM**

**SCHEMATIC: ON-LINE vs OFF-LINE**

**Detail 6** Isolation Diversion Structure

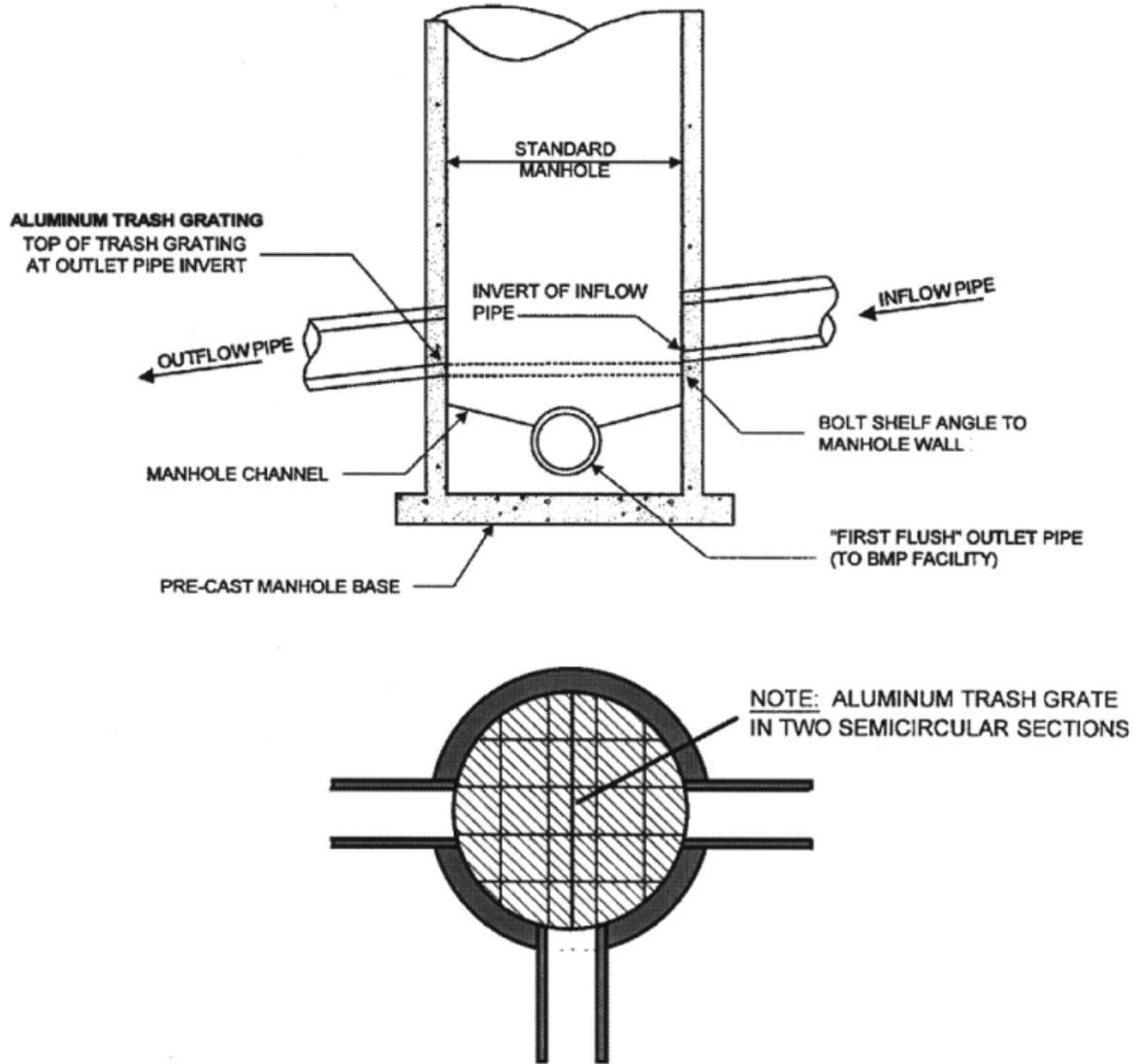

**TYPICAL ISOLATION / DIVERSION MANHOLE**

(Source: Bell, 1996)

**Detail 7 Half Round CMP Hood**

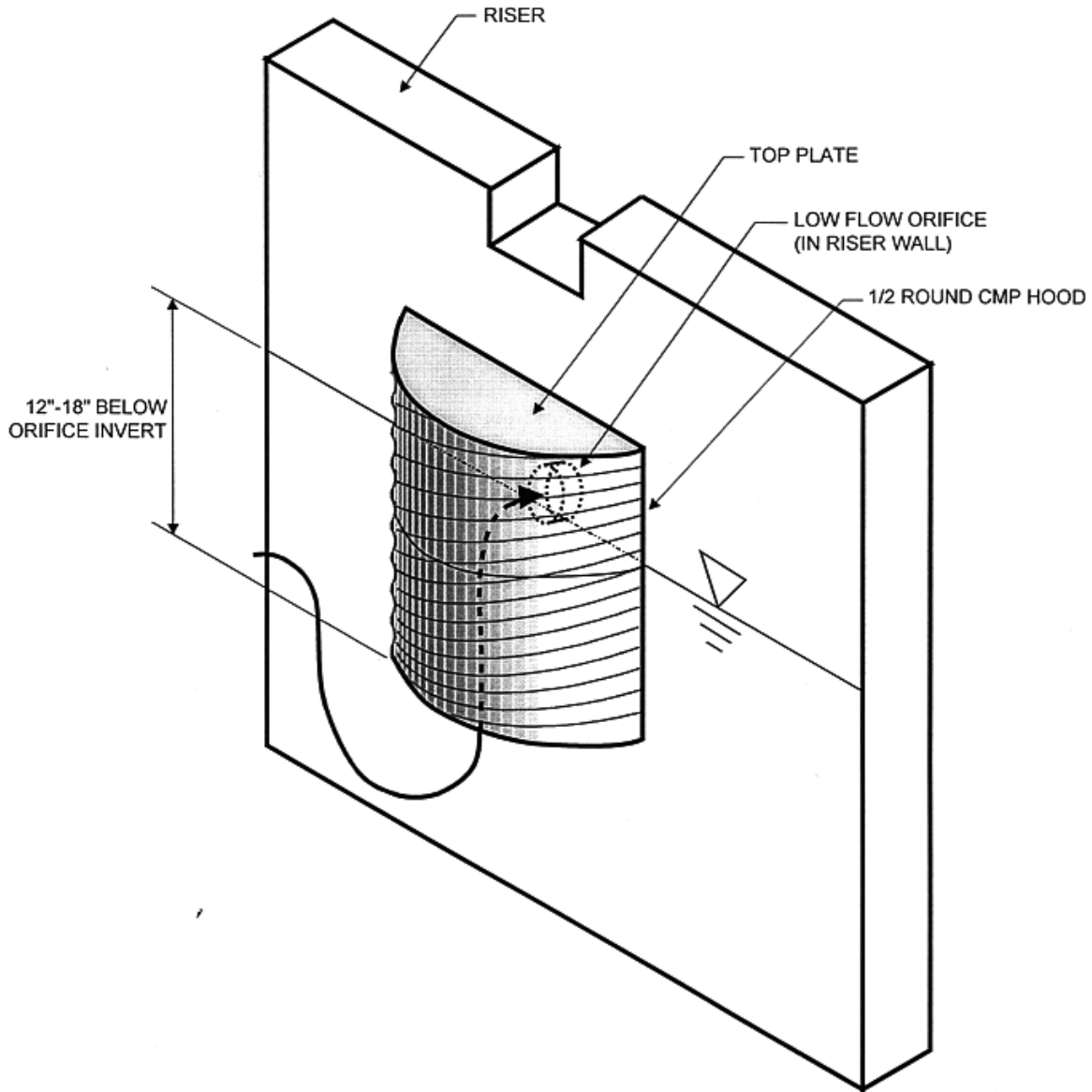

**1/2 ROUND CMP PIPE-HOOD**  
(FOR PROTECTION OF LOW FLOW ORIFICE)

**Detail 8** Half Round CMP Weir

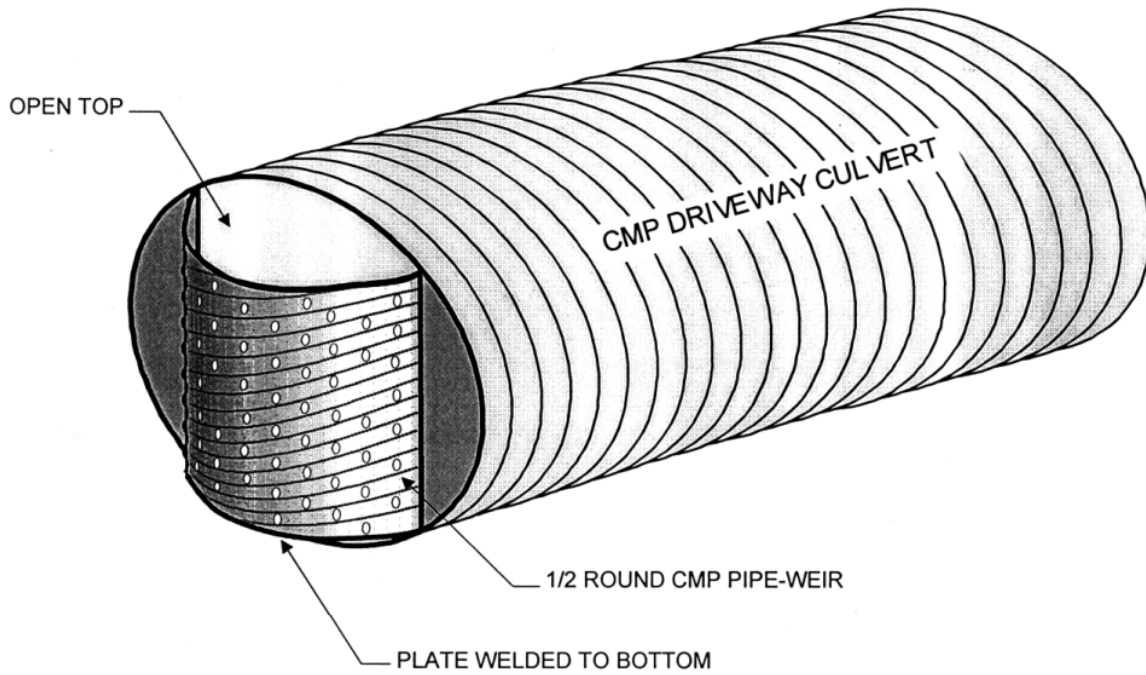

**1/2 ROUND CMP PIPE-WEIR**  
(FOR USE WITH DRY SWALE)

**Detail 9 Concrete Level Spreader**

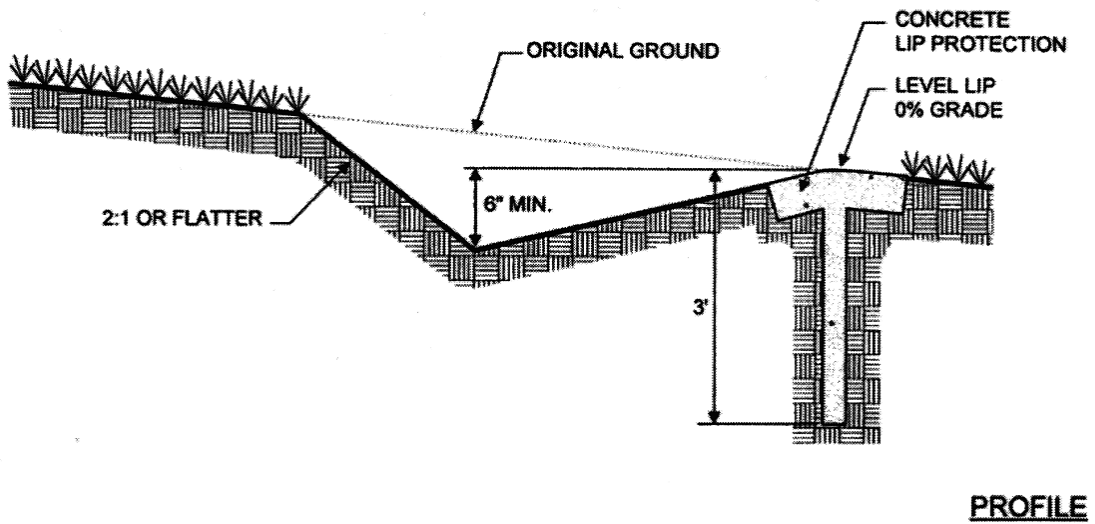
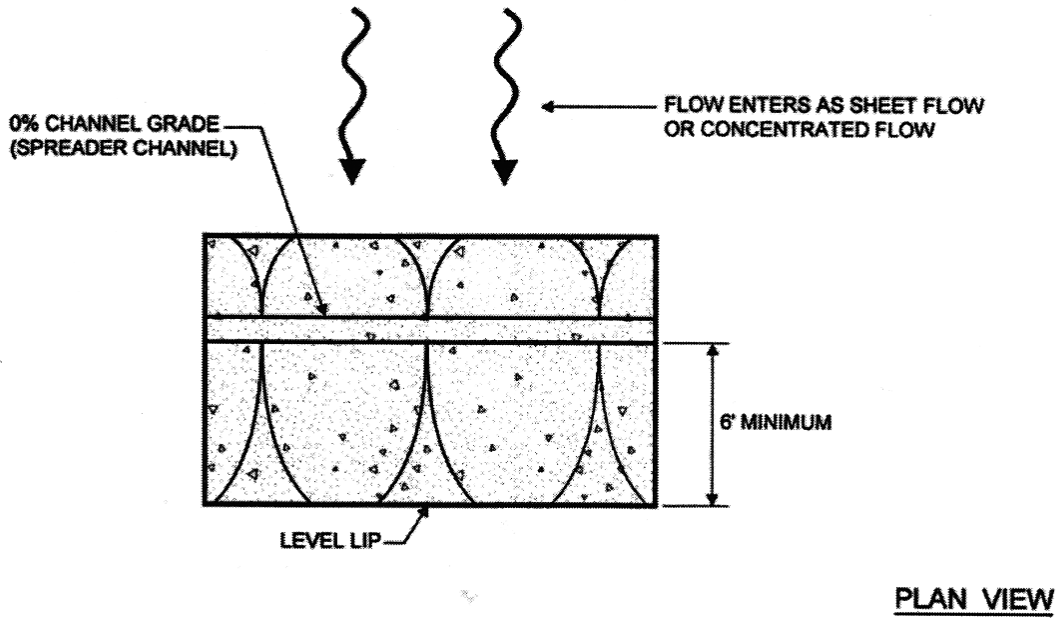

**LEVEL SPREADER**

Source: Virginia Erosion and Sediment Control Handbook, Virginia Soil and Water Conservation Commission, 1980

**Appendix**

**D.9**

**MD Stream Use Designations**



## **Introduction**

This Appendix, adapted from the Code of Maryland Regulations (COMAR) 26.08.02.08 “Stream Segment Designations”, is reprinted here for informational purposes only. Please use the Code of Maryland Regulations for the Official Version and for any updates to these designations.

The stream segments are listed in tabular form according to Use designations as follows:

- Water Contact Recreation, and Protection of Aquatic Life (Use I and Use I-P waters)
- Shell Fish Harvesting Waters (Use II waters);
- Natural Trout Waters (Use III and Use III-P waters);
- Recreational Trout Waters (Use IV and Use IV-P waters); and
- Public Water Supply (Use I-P, III-P, and IV-P waters).

For each sub-basin, information is arranged under the following headings:

- 1) Use – Refers to water classification;
- 2) Waters – Exact name of stream segment or segments;
- 3) MCGS – Most downstream point or line for each stream segment using the Maryland Coordinate Grid System (East/North);
- 4) Limits – Written description of boundary of stream segment established by MCGS; and
- 5) Any stream segment not listed may be considered Use I waters.

Figure D.9.1 Maryland 6 Digit Sub-Basins

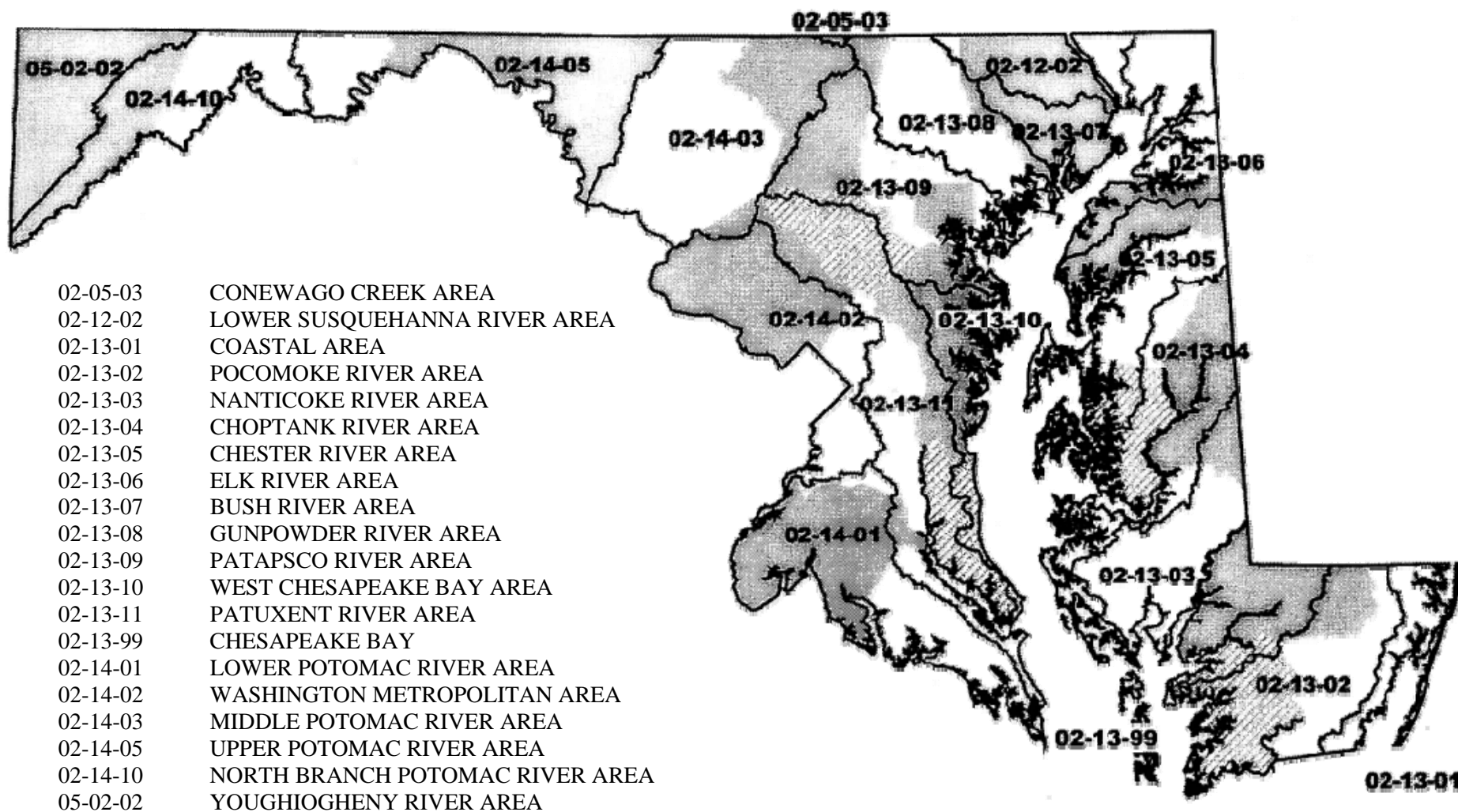

## Stream Segment Designations

<i>Use</i>	<i>Waters</i>	<i>MCGS*</i>	<i>Limits</i>
<b>A. SUB-BASIN 02-12-02: LOWER SUSQUEHANNA RIVER AREA</b>			
(1)	Use I-P: Susquehanna River and all tributaries except those designated below as Use III-P or Use-IV-P	From 1068.8/625.5 to 1056.8/621.3	Mainstem from mouth to MD/PA line
(2)	Use II: None		
(3)	Use III: None		
(4)	Use-III-P:		
(a)	Deer Creek and all tributaries	956/671	Above Eden Mill Dam
(b)	Basin Run and all tributaries	1040/667	
(c)	Kellogg Branch and all tributaries	966/655.5	
(d)	North Stirrup Run and all tributaries	969/650.2	
(e)	South Stirrup Run and all tributaries	968.3/649	
(f)	Deep Run and all tributaries	1008.2/677.8	
(g)	Gladden Branch and all tributaries	967/658	
(h)	Rock Hollow branch and all tributaries	958/663	
(i)	Love Run and all tributaries	1046/678	
(j)	Stone Run and all tributaries	1050.5/682.5	
(5)	Use IV: None		
(6)	Use IV-P:		
(a)	Deer Creek and all tributaries	1040/649.3	From mouth to Eden Mill Dam
(b)	Octoraro Creek	1036.7/665	Mainstem only
<b>B. SUB-BASIN 02-13-01: COASTAL AREA</b>			
(1)	Use I-P: None		
(2)	Use II: All portions of the territorial seas and estuarine portions of bays and tributaries except:		
(a)	Bishopville Prong and tributaries	1321.7/216.4	Above confluence with St. Martins River
(b)	Shingle Landing Prong and its tributaries	1323/214	Above confluence with St. Martins River at Piney Island
(c)	Herring Creek and its tributaries	1336.4/189.9	Above Rt. 50
(d)	Ocean City Harbor	1345/185.5	Above entrance to West Ocean City Harbor
(3)	Use III: None		
(4)	Use IIII-P: None		
(5)	Use IV: None		
(6)	Use IV-P: None		
<b>C. SUB-BASIN 02-13-02: POCOMOKE RIVER AREA</b>			

\* Most downstream point or line for the segment using the Maryland Coordinate Grid System (MCGS) (East/North)

- (1) Use I-P: None
- (2) Use II: All estuarine portions of tributaries except:
  - (a) Manokin River and tributaries
  - (b) Big Annemessex River and tributaries
  - (c) Jenkins Creek
  - (d) Fair Island Canal
  - (e) Pocomoke River
- (3) Use III: None
- (4) Use III-P: None
- (5) Use IV: None
- (6) Use IV-P: None

1165/125.3

Above confluence of Manokin River &amp; Kings Creek

1160.8/95.2

Above River Road

From 1127/48 to 1127.3/45.7

Above mouth

From 1177.6/51 to 1187.7/50.1

1196/62

Above MD/VA line

#### D. SUB-BASIN 02-13-03: NANTICOKE RIVER AREA

- (1) Use I-P: None
- (2) Use II; All estuarine portions of tributaries except:
  - (a) Blackwater River and tributaries
  - (b) Transquaking River and tributaries
  - (c) Nanticoke River and tributaries
  - (d) Wicomico River and tributaries
  - (e) Monie Creek
- (3) Use III: None
- (4) Use III-P: None
- (5) Use IV: None
- (6) Use IV-P: None

From 1083.1/92 to 1084.2/191.6

Above mouth

From 1085.2/196.3 to 1088/197

From 1126/194 to 1128.2/191.2

1147.9/160.5

Above mouth

1138.7/146.7

Above line from Runaway Pt. to Long Pt.

Above ferry crossing at White Haven

Above mouth

#### E. SUB-BASIN 02-13-04: CHOPTANK RIVER AREA

- (1) Use I-P: None
- (2) Use II: All estuarine portions of tributaries except:
  - (a) Choptank River and tributaries
  - (b) Tred Avon River and tributaries
- (3) Use III: None
- (4) Use III-P: None
- (5) Use IV: None
- (6) Use IV-P: None

From 1099.3/308 to 1101/306.5

Above line from Bow Knee Pt. to Wright Wharf

1057.6/341.6

Above Easton Pt.

#### F. SUB-BASIN 02-13-05: CHESTER RIVER AREA

- (1) Use I-P: None

## (2) Use II: All estuarine portions of tributaries except:

- |                                   |                                    |                 |
|-----------------------------------|------------------------------------|-----------------|
| (a) Chester River and tributaries | 1066.5/502                         | Above Rt. 213   |
| (b) Corsica River                 | 1060.4/448.4                       | Above Earl Cove |
| (c) Piney Creek                   | From 1010.7/419.9 to<br>1012/418.8 | Above Rt. 50    |
| (d) Winchester Creek              | 1026.5/416.1                       | Above mouth     |
| (e) St. Michaels Harbor           | 1023/348.7                         |                 |

## (3) Use III: None

## (4) Use III-P: None

## (5) Use IV: None

## (6) Use IV-P: None

## G. SUB-BASIN 02-13-06: ELK RIVER

## (1) Use I-P:

- |   |              |                                  |
|---|--------------|----------------------------------|
| (a) Big Elk Creek and all tributaries   | 1129.3/647.5 | Above Md Rt. 213                 |
| (b) Northeast Creek and all tributaries | 1096.6/643.1 | Above confluence with Stoney Run |
| (c) Mill Creek and all tributaries      | 1065.9/636   | Above US Rt. 40                  |

## (2) Use II: All estuarine portions of tributaries except

- |  |   |   |
|--|---|---|
| (a) Elk River and tributaries                    | From 1112.8/617 to<br>1114.8/613.9                                    | Above line from Bull Minnow Pt. to Courthouse Pt. |
| (b) Bohemia River and tributaries                | From 1108/603.7 to 1109/600   | Above line from Rich Pt. to Baltery Pt.           |
| (c) Sassafras River and tributaries              | 1088.6/561.5  | Above Ordinary Pt.                                |
| (d) Stillpond Creek and tributaries (Still Pond) | 1044/547  | Above Kinnaird Pt.                                |
| (e) Worton Creek                                 | From 1031.4/532 to<br>1032.5/534.7                                    | Above mouth                                       |
| (f) Fairlee Creek                                | From 1023.6/524 to 1026/527.5<br>From 1081.3/623.3 to<br>1087.6/619.1 | Above mouth                                       |
| (g) Northeast River                              | 1073/634.5  |   |

## (3) Use III: Principio Creek and all tributaries

## (4) Use III-P: None

## (5) Use IV: None

## (6) Use IV-P: None

## H. SUB-BASIN 02-13-07: BUSH RIVER AREA

- |  |             |   |
|--|-------------|---|
| (1) Use I-P: Winters Run and all tributaries, including Atkisson Reservoir | 995.5/585.5 | From Otter Point Creek to upstream boundary of Atkisson Reservoir |
| (2) Use II: All estuarine portions of tributaries except:                  |             |   |

(a) Bush River and tributaries	From 1010.5/576 to 1014.1/574.1	Above line from Fairview Pt. to Chillbury Pt.
(b) Romney Creek	1022.3/567.5	Above Briar Pt.
(c) Swan Creek and tributaries	From 1050/603.5 to 1047.5/604.2	Above mouth
(3) Use III: Bynum Run and all tributaries	1008.9/597.4	
(4) Use III-P: None		
(5) Use IV: None		
(6) Use IV-P: Winters Run and all tributaries	982.2/604.8	Above Atkisson Reservoir
<b>I. SUB-BASIN 02-13-08: GUNPOWDER RIVER AREA</b>		
(1) Use I-P: None		
(2) Use II: All estuarine portions of tributaries except:		
(a) Gunpowder River and all tributaries	From 987/561.5 to 991.2/555.5 From 972/536.1 to 970/532.5	Above line from Oliver Pt. to Maxwell Pt.
(b) Middle River		Above line from Log Pt. to Turkey Pt.
(3) Use III:		
(a) Little Gunpowder Falls and all tributaries	976.8/5788.8	Above B&O railroad bridge ¾ mile south of Rt. 7 (Old Philadelphia Road)
(b) Long Green Run and all tributaries	950/584	
(c) Sweathouse Branch and all tributaries	950/584	
(4) Use III-P: Gunpowder Falls and all tributaries	930.8/578.9	Above Loch Raven
(5) Use IV: Whitemarsh Run and all tributaries	964/564	
(6) Use IV-P: None		
<b>J. SUB-BASIN 02-13-09: PATAPSCO RIVER AREA</b>		
(1) Use I-P:		
(a) Liberty Reservoir	830.9/562.1	Above Liberty Dam
(b) All tributaries to West Branch Patapsco River	828.8/621.4	
(c) All tributaries to North Branch Patapsco River except those designated below as Use III-P or Use IV-P	835.8/604.8	Above Liberty Reservoir
(2) Use II: None		
(3) Use III:		
(a) Brice Run and all tributaries	850/540	
(b) Piney Run and all tributaries	From 828/554 to 815.8/563.6	From mouth to Slacks Road (on Springfield State Hospital Grounds) Above Lake Roland
(c) Jones Falls and all tributaries	897.7/567.6	
(d) Red Run and all tributaries	863/572.4	
(e) Gwynns Falls and all tributaries	861.5/578.5	Above Reistertown Road
(f) Gillis Falls and all tributaries	782/557	
(g) South Branch Patapsco River and all tributaries	782/557	Above confluence with Gillis Falls tributaries

(h) Unnamed tributary to the South Branch Patapsco River at Henryton and all tributaries to this unnamed tributary	823.9/552.9	
(4) Use III-P:		Above Slacks Road (on Springfield State Hospital Grounds)
(a) Piney Run and all tributaries	815.8/563.6	
(b) Morgan Run and all tributaries	813.8/589.6	
(c) Norris Run and all tributaries	835.1/592.6	
(d) Cooks Branch and all tributaries	836.2/584.4	
(e) Keyzers Run and all tributaries	833.8/596.8	
(f) Beaver Run and all tributaries	828.3/602.1	
(g) Snowdens Run and all tributaries	825/572	
(h) Stillwater Creek and all tributaries	824.8/570.9	
(i) Carroll Highlands Run and all tributaries	825.5/567.4	
(j) Autumn Run and all tributaries	825.7/567	
(k) Locst Run and all tributaries	839.1/572.9	
(l) Glen Falls Run and all tributaries	837.4/605.1	
(m) East Branch Patapsco River and all tributaries	830.1/620.4	
(5) Use IV:		
(a) South Branch Patapsco River	833.4/552.5	Mainstem only
(b) Jones Falls	From 908/538.5 to 901/563	From North Ave. to Lake Roland Dam
(c) Herring Run and all tributaries	929.5/537	Above I-95
(d) Stony Run and all tributaries	905/541	
(e) Dead Run and all tributaries	888/536.5	
(f) Stemmers Run and all tributaries	941.4/553.8	Above I-95
(6) Use IV-P:		
(a) North Branch Patapsco River	833.4/552.2	Mainstem only above Liberty Reservoir
(b) West Branch Patapsco River	830.1/620.3	Mainstem only
(c) Cranberry Branch and all tributaries	888.1/637.3	Above Md Rt. 852 (Old Manchester Rd)

#### K. SUB-BASIN 02-13-10: WEST CHESAPEAKE BAY AREA

(1) Use I-P: None		
(2) Use II: All estuarine portions of tributaries except:		
(a) Magothy River and tributaries	936.9/455	Above Henderson Pt
(b) Severn River and tributaries	920.6/451	Above mouth of Forked Creek
(c) South River and tributaries	918.8/410.1	Above Porter Pt.
(d) Rockhold Creek and tributaries	925.7/315.8	Above Mason Beach Road
(e) Tracys Creek	924.5/344.2	
(3) Use III: Jabez Branch and all tributaries	905/455	
(4) Use III-P: None		
(5) Use IV: Severn Run and all tributaries	907.3/454.1	Above Rt.3
(6) Use IV-P: None		

#### L. SUB-BASIN 02-13-11: PATUXENT RIVER AREA

- |   |             |  |
|---|-------------|--|
| (1) Use I-P:  |             |  |
| (a) Little Patuxent River and all tributaries   | 866.5/453.8 | Above Old Forge Bridge (1 mile south of MD Route 198)  |
| (b) Patuxent River and all tributaries except those designated below as Use III-P or IV-P | 845.8/467.4 | Above Rocky Gorge Dam  |
| (2) Use II: All estuarine portions of tributaries except Patuxent River and tributaries   | 886.8/316.3 | Above Ferry Landing  |
| (3) Use III: None   |             |  |
| (4) Use III-P: Patuxent River and tributaries   | 787.2/510.7 | Above Triadelphia Reservoir  |
| (5) Use IV: None  |             |  |
| (6) Use IV-P: Patuxent River and tributaries  | 813.2/476.8 | Between Rocky Gorge Reservoir and Triadelphia Reservoir, and including Triadelphia Reservoir |

#### M. SUB-BASIN 02-14-01: LOWER POTOMAC RIVER AREA

- |  |                                 |  |
|--|---------------------------------|--|
| (1) Use I-P: Tilghman Lake Reservoir   | 817/260                         |  |
| (2) Use II: All estuarine portions of tributaries except Potomac River and tributaries | From 723.8/211.8 to 710.9/205.3 | Above line from Smith Pt. to Simms Pt. |
| (3) Use III: None  |                                 |  |
| (4) Use III-P: None  |                                 |  |
| (5) Use IV: None   |                                 |  |
| (6) Use IV-P: None   |                                 |  |

#### N. SUB-BASIN 02-14-02: WASHINGTON METROPOLITAN AREA

- |  |                                       |   |
|--|---------------------------------------|---|
| (1) Use I-P: Potomac River and all tributaries except those designated below as Use III, Use III-P, Use IV or Use IV-P | 766/401                               | From MD/DC line to Frederick/Montgomery County line   |
| (2) Use II: None   |                                       |   |
| (3) Use III:   |                                       |   |
| (a) Paint Branch and all tributaries   | 815.2/433.2                           | Above Capital Beltway (I-495)   |
| (b) Rock Creek and all tributaries   | 764/475                               | Above Muncaster Mill Road   |
| (c) North Branch Rock Creek and all tributaries  | 771.5/468                             | Above Muncaster Mill Road   |
| (4) Use III-P:   |                                       |   |
| (a) Little Seneca Creek and all tributaries  | From 704/477.4 to 716/491.3           | From the stream's confluence with Bucklodge Branch to the Baltimore and Ohio railroad bridge (see Regulation 26.08.02.03-3E(1) of this chapter) |
| (b) Wildcat Branch and all tributaries   | 740.5/504                             |   |
| (5) Use IV:  |                                       |   |
| (a) Rock Creek and all tributaries   | From 766.7/459.3 to 763.5/475 809/413 | From Rt. 28 to Muncaster Mill Road  |
| (b) Northwest Branch and all tributaries   |                                       | Above east-West Highway (Rt. 410)   |
| (6) Use IV-P: Little Seneca Creek and all tributaries  | 719.2/497.4                           |   |

#### O. SUB-BASIN 02-14-03: MIDDLE POTOMAC RIVER AREA



(1) Use I-P: Potomac River and all tributaries except those designated below as Use III-P or Use IV-P	671/505.9	From Frederick/Montgomery County Line to confluence with Shenandoah River
(2) Use II: None		
(3) Use III: None		
(4) Use III-P:		
(a) Tuscarora Creek and all tributaries	694/592	
(b) Carroll Creek and all tributaries	678.5/579.5	Above U.S. Rt. 15
(c) Rocky Fountain Run and all tributaries	681/546	
(d) Fishing Creek and all tributaries	689.2/609.2	
(e) Hunting Creek and all tributaries	698.5/625.5	
(f) Owens Creek and all tributaries	705.9/635.9	
(g) Friends Creek and all tributaries	697.2/689.1	
(h) Catoctin Creek and all tributaries	640.6/589.8	Above Alternate U.S. Rt. 40
(i) Little Bennett Creek and all tributaries	711/527	Above Md. Rt. 355
(j) Furnace Branch and all tributaries	675/514	
(k) Ballenger Creek and all tributaries	557/683	
(l) Bear Branch and all tributaries	685.2/531.9	From confluence with Bennett Creek
(5) Use IV: None		
(6) Use IV-P:		
(a) Monacacy River and all tributaries except those designated above as Use III-P	696/570	Above U.S. Rt. 40
(b) Catoctin Creek	640.6/538	Mainstem only, below Alternate U.S. Route 40
(c) Israel Creek and all tributaries	607/545	
<b>P. SUB-BASIN 02-14-05: UPPER POTOMAC RIVER AREA</b>		
(1) Use I-P: Potomac River and all Maryland tributaries except those designated below as Use III-P or Use IV-P	543.3/594.4	From confluence of Shenandoah River to the confluence of the North and South Branches of the Potomac River
(2) Use II: None		
(3) Use III: None		
(4) Use III-P:		
(a) Town Creek tributaries	365/618.8	
(b) Beaver Creek and all tributaries	599.9/620.3	In Antietam Creek Watershed
(c) Marsh Run and all tributaries	605.7/662.1	In Antietam Creek Watershed
(d) Little Antietam Creek and all tributaries	620/674	
(e) Camp Spring Run and all tributaries	536/653	
(5) Use IV: None		
(6) Use IV-P:		
(a) Town Creek	365/618.8	
(b) Fifteen Mile Creek and all tributaries	410.1/655	
(c) Sideling Hill Creek and all tributaries	424.5/660	
(d) Tonoloway Creek and all tributaries	474.8/679.8	

- |   |             |  |
|---|-------------|--|
| (e) Licking Creek and all tributaries   | 504/663.5   |  |
| (f) Conococheague Creek and all tributaries                                       | 566.3/645.4 |  |
| (g) Antietam Creek and all tributaries except those designated above as Use III-P | 58901/577.8 |  |

#### Q. SUB-BASIN 02-14-10: NORTH BRANCH POTOMAC RIVER AREA

- |   |                                       |   |
|---|---------------------------------------|---|
| (1) Use I-P:  |                                       |   |
| (a) North Branch Potomac River mainstem   | 352.3/621.1                           | From the confluence of the North and South Branches of the Potomac River to the MD/WVA State line |
| (b) Georges Creek mainstem  | 222.8/607.4                           | From the confluence with N. Branch  |
| (c) Mill Run and its tributaries in Allegany County                                   | 272.2/625.8                           | From the confluence with N. Branch (near Rawlings and Rawlings Heights)                           |
| (d) an unnamed tributary near Pinto   | 281.7/636.5                           | Confluence of the unnamed tributary with the North Branch of the Potomac River                    |
| (2) Use II: None  |                                       |   |
| (3) Use III: None   |                                       |   |
| (4) Use III-P: All Maryland tributaries to the North Branch Potomac River except for: | From 352.3/621.1 to MD/WVA State line | From confluence of North and South Branches of the Potomac River to MD/WVA State line             |
| (a) Those designated below as Use IV-P waters   |                                       |   |
| (b) Those designated above as Use I-P waters  |                                       |   |
| (5) Use IV: None  |                                       |   |
| (6) Use IV-P:   |                                       |   |
| (a) Wills Creek   | 303.3/655.5                           | Mainstem only   |
| (b) Evitts Creek  | 310.2/656.8                           | Mainstem only   |

#### R. SUB-BASIN 05-02-02: YOUGHIOGHENY RIVER AREA

- |   |             |   |
|---|-------------|---|
| (1) Use I-P:  |             |   |
| (a) Broad Ford Run and all tributaries                                  | 130/579     | Above Dam   |
| (b) Piney Creek and all tributaries in Maryland                         | 232/687     | Upstream from confluence with Church Creek  |
| (2) Use II: None  |             |   |
| (3) Use III:  |             |   |
| (a) South Branch, Casselman River                                       | 187.7/674.0 | Confluence of North and South Branches  |
| (b) Piney Creek and all tributaries in Maryland, including Church Creek | 223.9/693.9 | From MD/PA State line to confluence of Church Creek                                 |
| (4) Use III-P: Youghiogheny River and all tributaries                   | 126.8/696.2 | Upstream of MD/PA State line joining mainstem of the Youghiogheny River in Maryland |
| (5) Use-IV: Casselman River   | 205.5/694.8 | Mainstem only, confluence of South Branch & North Branch to PA line                 |
| (6) Use IV-P: None  |             |   |

#### S. SUB-BASIN 02-05-03: CONEWAGO CREEK

- |                   |  |  |
|-------------------|--|--|
| (1) Use I-P: None |  |  |
|-------------------|--|--|

- (2) Use II: None
- (3) Use III: None
- (4) Use III-P: None
- (5) Use IV: None
- (6) Use IV-P: None

T. SUB-BASIN 02-13-99: CHESAPEAKE BAY (PROPER)

- (1) Use I-P: None
- (2) Use II: All waters of the Chesapeake Bay Proper

- (3) Use III: None
- (4) Use III-P: None
- (5) Use IV: None
- (6) Use IV-P: None

From the Susquehanna River mouth to the Virginia State line, including the tidal waters of the Chesapeake Bay bounded generally by the shoreline of the Bay and by “zero river mile” lines of estuaries and tributaries to the Bay, as designated by the Department of the Environment, and any peripheral waters designated as part of the Chesapeake Bay Proper by the Department of the Environment after consultation with the Tidewater Administration and the Forest, Park and Wildlife Service

<u>Designator</u>	<u>Sub-Basin</u>
02-12-02	Lower Susquehanna River Area
02-13-01	Coastal Area
02-13-02	Pocomoke River Area
02-13-03	Nanticoke River Area
02-13-04	Choptank River Area
02-13-05	Chester River Area
02-13-06	Elk River Area
02-13-07	Bush River Area
02-13-08	Gunpowder River Area
02-13-09	Patapsco River Area
02-13-10	West Chesapeake Bay Area
02-13-11	Patuxent River Area
02-14-01	Lower Potomac River Area
02-14-02	Washington Metropolitan Area
02-14-03	Middle Potomac River Area
02-14-05	Upper Potomac River Area
02-14-10	North Branch Potomac River Area
05-02-02	Youghiogheny River Area
02-05-03	Conewago Creek Area
02-13-99	Chesapeake Bay

**Appendix  
D.10**

**Method for Computing Peak Discharge  
for Water Quality Storm**

---

**METHOD FOR COMPUTING PEAK DISCHARGE FOR WATER QUALITY STORM**

(Adapted from Claytor and Schueler, 1996)

The peak rate of discharge is needed for the sizing of off-line diversion structures and to design grass channels. Conventional SCS methods underestimate the volume and rate of runoff for rainfall events less than 2". This discrepancy in estimating runoff and discharge rates can lead to situations where a significant amount of runoff by-passes the filtering treatment practice due to an inadequately sized diversion structure or leads to the design of undersized grass channels.

The following procedure can be used to estimate peak discharges for small storm events. It relies on the volume of runoff computed using the Small Storm Hydrology Method (Pitt, 1994) and utilizes the NRCS, TR-55 Graphical Peak Discharge Method (USDA, 1986).

- Using the  $WQ_v$  methodology, a corresponding Curve Number (CN) is computed utilizing the following equation:

$$CN = \frac{1000}{[10 + 5P + 10Q_a - 10\sqrt{Q_a^2 + 1.25Q_aP}]}$$

where:  $P$  = rainfall, in inches (use 1.0" or 0.9" for the Water Quality Storm)

$Q_a$  = runoff volume, in inches (equal to  $P3R_v$ )

Note: The above equation is derived from the SCS Runoff Curve Number method described in detail in NEH-4, Hydrology (SCS 1985) and SCS TR-55 Chapter 2: Estimating Runoff. The CN can also be obtained graphically using Figure D.10.1 or from TR-55.

- Once a CN is computed, the time of concentration ( $t_c$ ) is computed (based on the methods identified in TR-55, Chapter 3: "Time Of Concentration And Travel Time").
- Using the computed CN,  $t_c$  and drainage area ( $A$ ), in acres; the peak discharge ( $Q_p$ ) for the Water Quality Storm is computed (based on the procedures identified in TR-55, Chapter 4: "Graphical Peak Discharge Method"). Use Rainfall distribution type II.

- Read initial abstraction ( $I_a$ ), compute  $I_a/P$

- Read the unit peak discharge ( $q_u$ ) from Exhibit 4-II for appropriate  $t_c$

- Using the runoff volume ( $Q_a$ ), compute the peak discharge ( $Q_p$ );  $Q_p = q_u 3A 3Q_a$

where:

$Q_p$  = the peak discharge, in cfs

$q_u$  = the unit peak discharge, in cfs/mi<sup>2</sup>/inch

$A$  = drainage area, in square miles

$Q_a$  = runoff volume, in watershed inches

Example Calculation of Peak Discharge for Water Quality Storm

## Appendix D.10. Method for Computing Peak Discharge for Water Quality Storm

Using a 3.0 acre small shopping center having a 1.0 acre flat roof, 1.6 acres of parking, and 0.4 acres of open space, and using  $P = 1.0''$ ; the weighted volumetric runoff coefficient ( $R_v$ ) is:

$$\begin{aligned} R_v &= 0.05 + 0.009(I); I = 2.6 \text{ acres} / 3.0 \text{ acres} = 0.867 \text{ (86.7\%)} \\ &= 0.05 + 0.009(86.7\%) \\ &= 0.83 \end{aligned}$$

The runoff volume,  $Q_a$  is:

$$\begin{aligned} Q_a &= P3R_v \\ &= 1.0''30.83 \\ &= 0.83 \text{ watershed inches} \end{aligned}$$

and  $WQ_v$  is:

$$WQ_v = \frac{[(1.0'')(0.83)(3.0 \text{ acres})]}{12} \times \frac{43,560 \text{ ft}^2}{\text{acre}} = 9,039 \text{ ft}^3$$

Using  $Q_a = 0.83$  watershed inches and  $P = 1.0''$ ; CN for the water quality storm is:

$$CN = \frac{1000}{[10 + (5)(1.0'') + (10)(0.83) - 10\sqrt{(0.83)^2 + 1.25(0.83)(1.0'')}] = 98}$$

Using:

$$\begin{aligned} t_c &= 10 \text{ minutes (0.17 hour);} \\ I_a &= (200/CN)^2 = 0.041; \\ I_a \cdot P &= (0.041 \cdot 1.0'') = 0.041; \\ q_u &= 950 \text{ csm/in. (from TR-55 Exhibit 4-II); and} \\ A &= 3.0 \text{ acres} \cdot \frac{1}{640} \text{ mi}^2 \text{ per acre} = 0.0047 \text{ mi}^2 \end{aligned}$$

$$Q_p = (950 \text{ csm/in.})(0.0047 \text{ mi}^2)(0.83'') = 3.7 \text{ cfs}$$

For computing runoff volume and peak rate for storms larger than the Water Quality Storm (i.e., 2, 10 and 100 year storms), use the published CN's from TR-55 and follow the prescribed procedure in TR-55.

In some cases the Rational Formula may be used to compute peak discharges associated with the Water Quality Storm. The designer must have available reliable intensity, duration, frequency (IDF) tables or curves for the storm and region of interest. This information may not be available for many locations and therefore the TR-55 method described above is recommended.

Figure D-10.1 Curve Number (CN) for Water Quality Storm  
- Rainfall (P) =1.0" & 0.9"

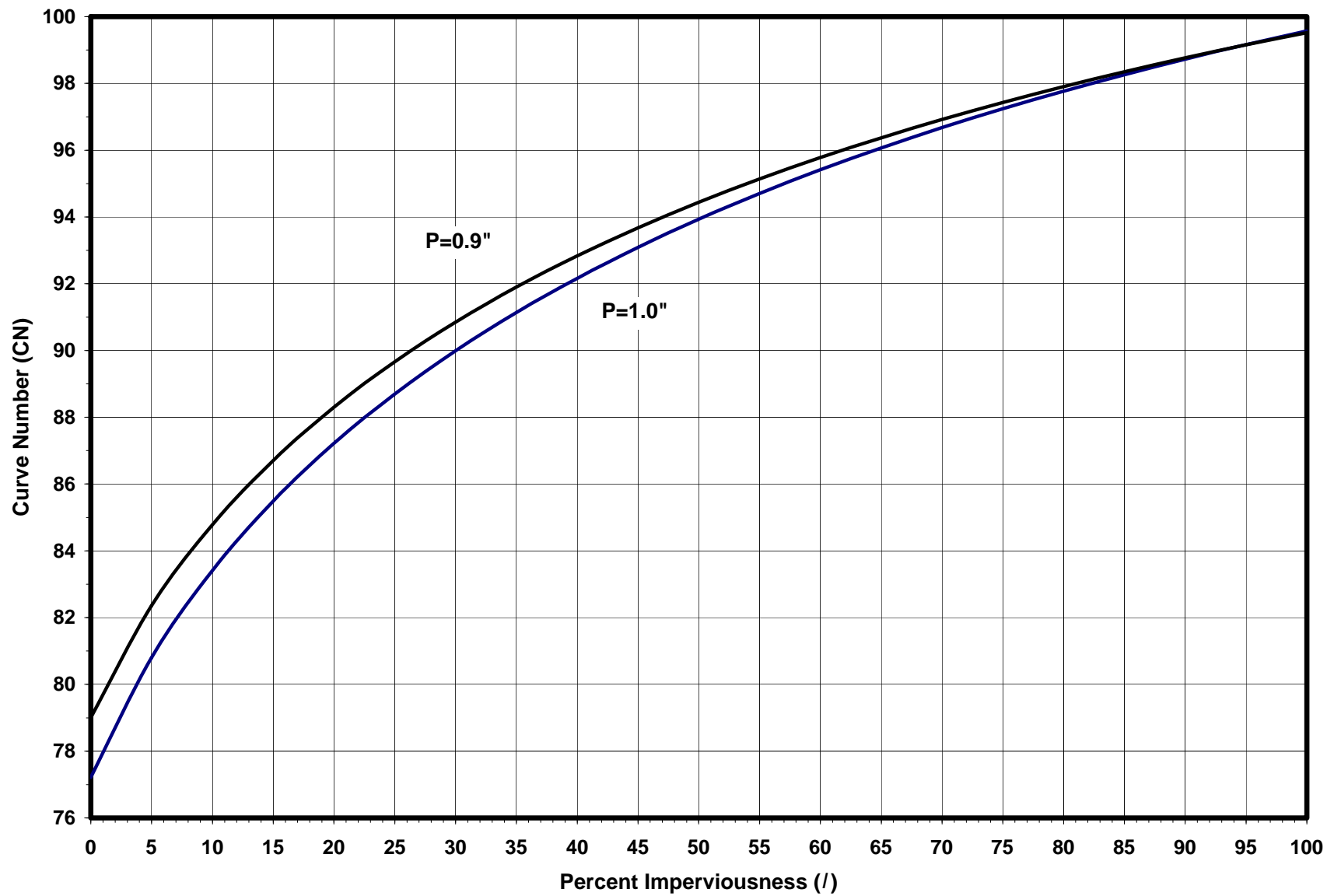

D.10.3



**References**

Pitt, R., 1994, Small Storm Hydrology. University of Alabama - Birmingham. Unpublished manuscript. Presented at design of stormwater quality management practices. Madison, WI, May 17-19 1994.

Schueler, T.R. and R.A. Claytor, 1996, Design of Stormwater Filter Systems. Center for Watershed Protection, Silver Spring, MD.

United States Department of Agriculture (USDA), 1986. Urban Hydrology for Small Watersheds. Soil Conservation Service, Engineering Division. Technical Release 55 (TR-55).

Appendix

## D.11

### Method for Computing the Channel Protection Storage Volume ( $Cp_v$ )

Appendix D.11..... Method for Computing the Channel Protection Storage Volume (Cp<sub>v</sub>)

---

The following procedure shall be used to design the channel protection storage volume (Cp<sub>v</sub>). The method is based on the Design Procedures for Stormwater Management Extended Detention Structures (MDE, 1987) and utilizes the NRCS, TR-55 Graphical Peak Discharge Method (USDA, 1986).

- ☞ Compute the time of concentration ( $t_c$ ) and the one-year post-development runoff depth ( $Q_a$ ) in inches.
- ☞ Compute the initial abstraction ( $I_a$ ) [ $I_a = 200/CN - 2$ ] and the ratio  $I_a/P$  where  $P$  is the one-year rainfall depth (see Table 2-2).
- ☞ With  $t_c$  and  $I_a/P$ , find the unit peak factor ( $q_u$ ) from Figure D.11.1 and compute the one year post-development peak discharge  $q_i = q_u A Q_a$  where  $A$  is the drainage in square miles.
- ☞ If  $q_i$  [ 2.0 cfs, Cp<sub>v</sub> is not required. Provide for water quality (WQ<sub>v</sub>) and groundwater recharge (Re<sub>v</sub>) as necessary.
- ☞ With  $q_u$ , find the ratio of outflow to inflow ( $q_o/q_i$ ) for T = 24 hours from Figure D.11.2 (use T=12 hours in USE III/IV waters).
- ☞ Compute the peak outflow discharge  $q_o = q_o/q_i \times q_i$
- ☞ With  $q_o/q_i$ , compute the ratio of storage to runoff volume ( $V_s/V_r$ ).

$$V_s/V_r = 0.683 - 1.43(q_o/q_i) + 1.64(q_o/q_i)^2 - 0.804(q_o/q_i)^3$$

- ☞ Compute the extended detention storage volume  $V_s = (V_s/V_r) \times V_r$  (note:  $V_r = Q_a$ );

Convert  $V_s$  to acre-feet by  $\frac{V_s}{12} \times A$ , where  $V_s$  is in inches and  $A$  is in acres.

- ☞ Compute the required orifice area ( $A_o$ ) for extended detention design:

$$A_o = \frac{q_o}{C\sqrt{2gh_o}} = \frac{q_o}{4.81\sqrt{h_o}}$$

where  $h_o$  is the maximum storage depth associated with  $V_s$ .

- ☞ Determine the required maximum orifice diameter ( $d_o$ )  $d_o = \sqrt{4A_o/\pi}$ .

A  $d_o$  of less than 3.0” is subject to local jurisdictional approval, and is not recommended unless an internal control for orifice protection is used (App. D.8).

**Figure D.11.1** SCS Graphical Method of Determining Peak Discharge ( $q_u$ ) in csm/in for 24-Hour Type II Storm Distribution

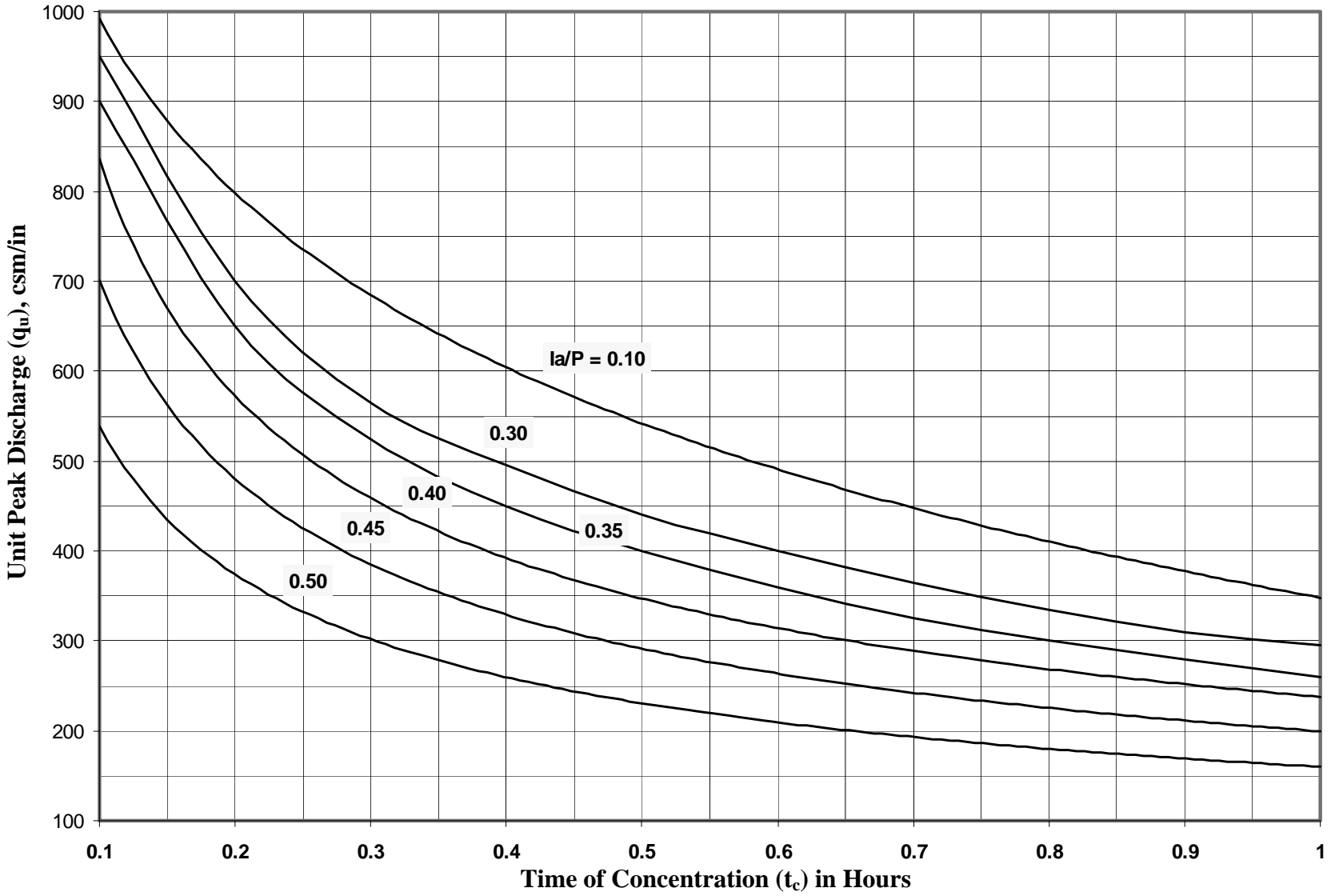
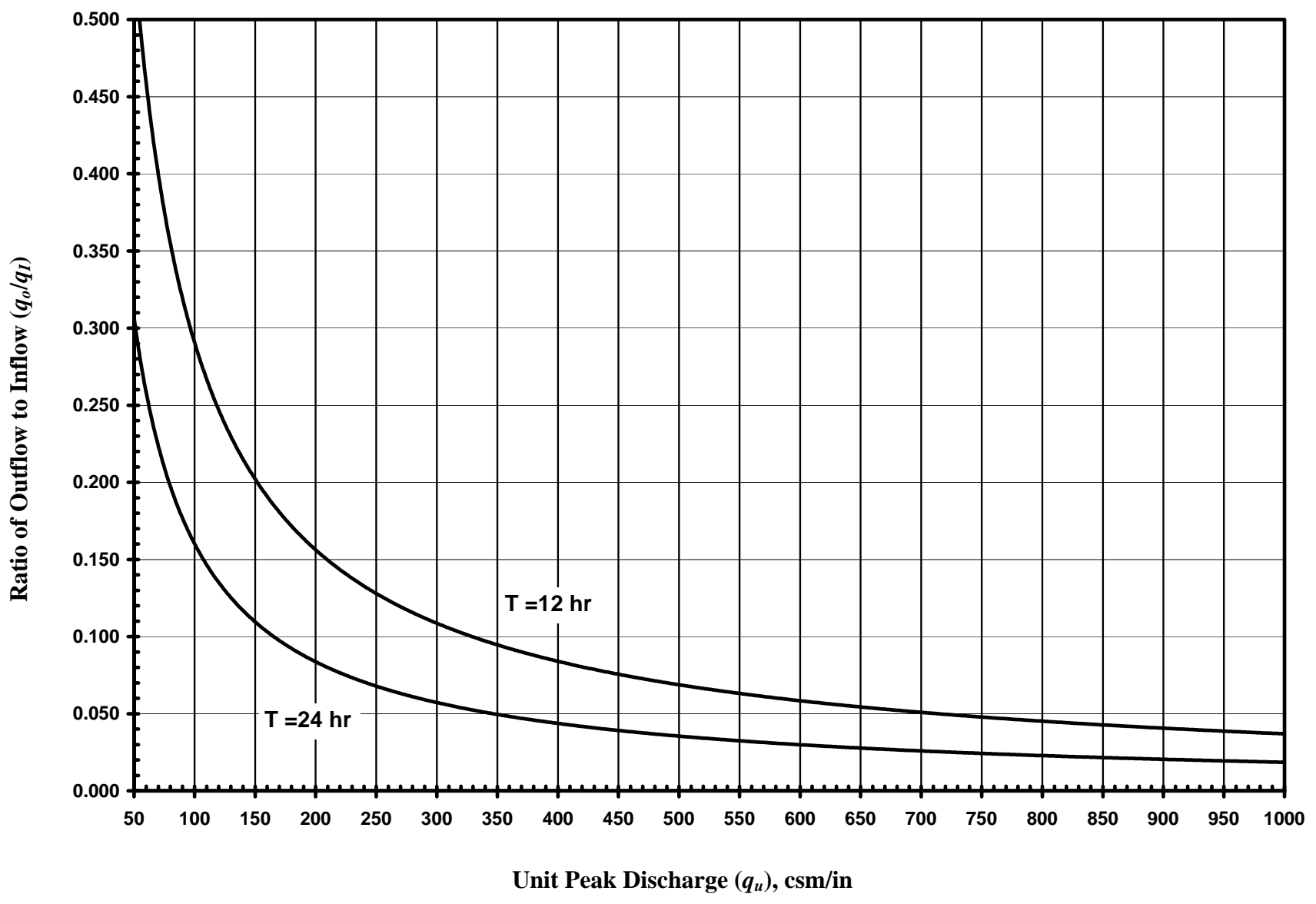

Figure D.11.2 Detention Time Versus Discharge Ratios ( $q_o/q_i$ )



D.11.3

**Appendix  
D.12**

**Critical Erosive Velocity for Grass and Soil**

**Velocity**

Maximum permissible velocities of flow shall not exceed the values shown on the following table:

**Table D.12.1** Permissible Velocities for Channels Lined with Vegetation

Channel Slope	Lining	Permissible Velocity <sup>1</sup> (ft/sec)
0-5%	Reed canarygrass Tall fescue Kentucky bluegrass	5
	Grass-legume mixture	4
	Red fescue Redtop Sericea lespedeza Annual lespedeza Small grains	2.5
5-10%	Reed canarygrass Tall fescue Kentucky bluegrass	4
	Grass-legume mixture	3
Greater than 10%	Reed canarygrass Tall fescue Kentucky bluegrass	3

<sup>1</sup> For highly erodible soils, permissible velocities should be decreased 25%. An erodibility factor (K) greater than 0.35 would indicate a highly erodible soil. Erodibility factors (K-factors) for Maryland soils are listed either in the Soil Survey or on the Soils-5 forms available in each Soil Conservation District or local NRCS office.

Source: Soil and Water Conservation Engineering, Schwab, *et al.*

**Appendix  
D.13**

**Method for Designing Infiltration Structures**



## **Introduction**

The following procedures shall be used for designing infiltration trenches (I-1) and basins (I-2) to meet the water quality ( $WQ_v$ ), the channel protection ( $Cp_v$ ), and the overbank flood protection ( $Qp$ ) volume requirements. These methods are based on the 1984 Maryland Standards and Specifications for Infiltration Practices (MDE, 1984) and Modelling Infiltration Practices Using TR-20 (MDE, 1983).

The use of infiltration practices depends on careful site investigation. The feasibility conditions listed in Chapter 3.3 and in Appendix D.1 are to be investigated and are equally important in ensuring the proper function of an infiltration practice. Should a site investigation reveal that any one of the feasibility tests is not adequate, the implementation of infiltration practices should not be pursued. Alternate feasibility criteria may be permitted only in those conditions where the local jurisdictions can justify and ensure proper application.

### **D.13.1 Soil Textures**

The hydrologic design methods presented in this appendix are based on the utilization of two hydrologic soil properties, the effective water capacity ( $C_w$ ) and the minimum infiltration rate ( $f$ ) of the specific soil textural groups, as shown in Table D.13.1. The effective water capacity of a soil is the fraction of the void spaces available for water storage, measured in inches per inch. The minimum infiltration rate is the final rate that water passes through the soil profile during saturated conditions, measured in terms of inches per hour. The hydrologic soil properties are obtained by identifying the soil textures by a gradation test for each change in soil profile. The soil textures presented in Table D.13.1 correspond to the soil textures of the U.S. Department of Agriculture (USDA) Textural Triangle presented in Figure D.13.1.

The data presented in Table D.13.1 are based on the analysis of over 5,000 soil samples by the USDA under carefully controlled procedures. The use of the soil properties established in Table D.13.1 for design and review procedures will offer two advantages. First, it provides for consistency of results in the design procedures. Second, it eliminates the need for the laborious and costly process of conducting field and laboratory infiltration and permeability tests.

**Table D.13.1** Hydrologic Soil Properties Classified by Soil Texture\*

<b>Texture Class</b>	<b>Effective Water Capacity (<math>C_w</math>)</b> (inch per inch)	<b>Minimum Infiltration Rate (<math>f</math>)</b> (inches per hour)	<b>Hydrologic Soil Grouping</b>
<b>Sand</b>	<b>0.35</b>	<b>8.27</b>	<b>A</b>
<b>Loamy Sand</b>	<b>0.31</b>	<b>2.41</b>	<b>A</b>
<b>Sandy Loam</b>	<b>0.25</b>	<b>1.02</b>	<b>A</b>
<b>Loam</b>	<b>0.19</b>	<b>0.52</b>	<b>B</b>
<b>Silt Loam</b>	<b>0.17</b>	<b>0.27</b>	<b>B</b>
<b>Sandy Clay Loam</b>	<b>0.14</b>	<b>0.17</b>	<b>C</b>
<b>Clay Loam</b>	<b>0.14</b>	<b>0.09</b>	<b>D</b>
<b>Silty Clay Loam</b>	<b>0.11</b>	<b>0.06</b>	<b>D</b>
<b>Sandy Clay</b>	<b>0.09</b>	<b>0.05</b>	<b>D</b>
<b>Silty Clay</b>	<b>0.09</b>	<b>0.04</b>	<b>D</b>
<b>Clay</b>	<b>0.08</b>	<b>0.02</b>	<b>D</b>

\* Source: Rawls, Brakensiek and Saxton, 1982

Based on the soil textural classes and the corresponding minimum infiltration rates, a restriction is established to eliminate unsuitable soil conditions. Soil textures with minimum infiltration rates less than 0.52 inches per hour are not suitable for usage of infiltration practices. These include soils that have a 30 percent clay content, making these soils susceptible to frost heaving and structurally unstable, in addition to having a poor capacity to percolate runoff. Soil textures that are recommended for infiltration systems include those soils with infiltration rates of 0.52 inches per hour or greater, which include loam, sandy loam, loamy sand, and sand.

Figure D.13.1 USDA Soils Textural Triangle

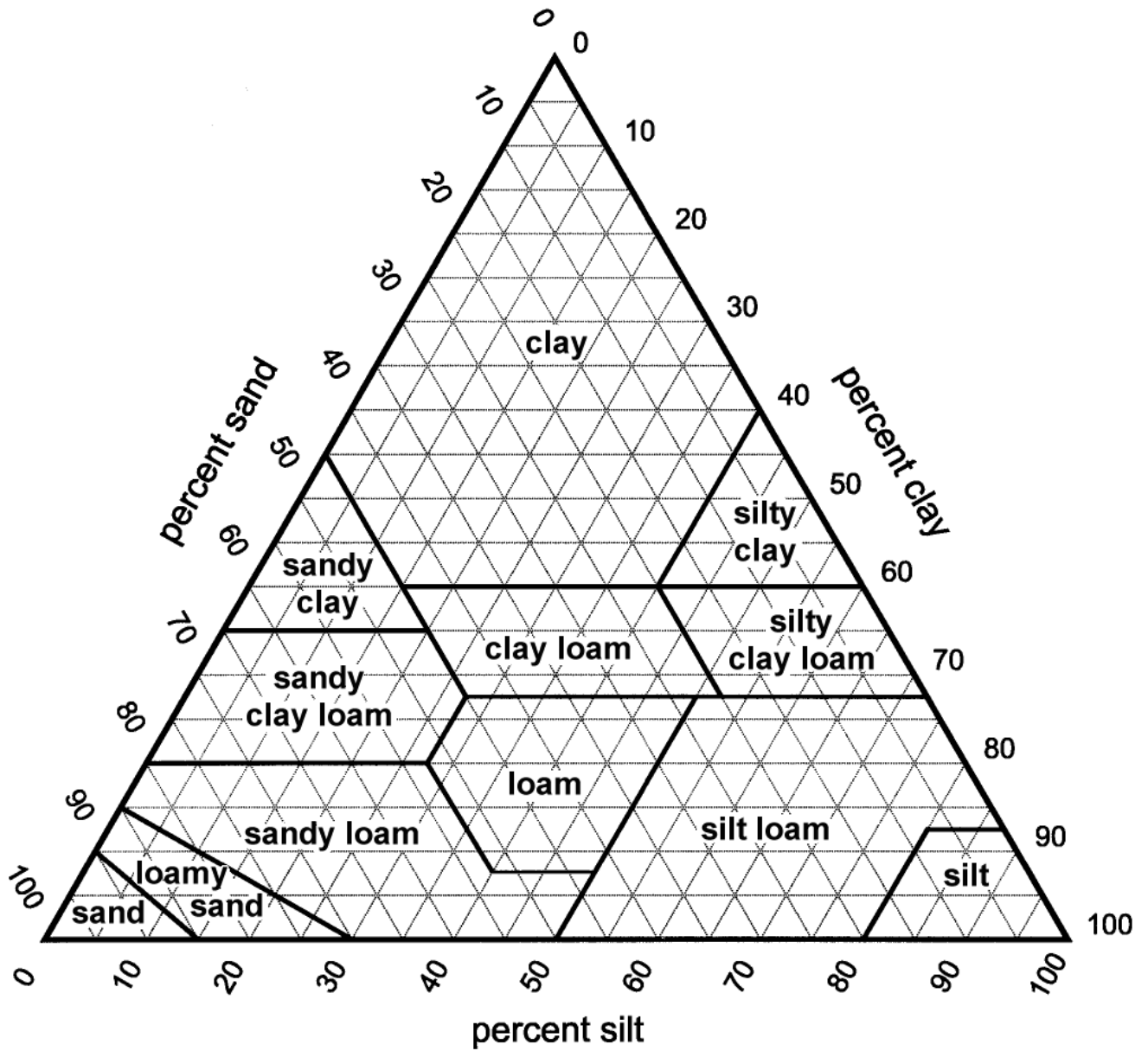

## D.13.2 Hydrologic Design Methods

### D.13.2.1 General Design Situations

There are two general types of situations where infiltration practices may be used. First, one may be interested in the dimensions of an infiltration device that is required to provide storage of the  $WQ_v$ , and/or the  $Cp_v$  or  $Q_p$ . Second, site conditions may dictate the layout and capacity of infiltration measures and one might be interested in determining the level of control provided by such a layout. In the latter case, control may not be sufficient and additional control, possibly using other acceptable Best Management Practices (BMPs), may be required. It is important to emphasize that the same principles of design apply to both cases.

Design methodologies are presented for two infiltration practices: infiltration trenches (I-1) and infiltration basins (I-2). The design procedures are based on either intercepting the  $WQ_v$  from the area contributing runoff or using the truncated hydrograph method for control of the runoff from an area for either  $Cp_v$  or  $Q_p$ . The design equations may be defined for either case of stormwater quality or quantity control because the volume of water ( $V_w$ ) stored in the individual infiltration practice may be determined from the methods described in Chapter 2 (for  $WQ_v$ ) and in Appendix D.13.3 for  $Cp_v$  and/or  $Q_p$ .

### D.13.2.2 Design of Infiltration Trenches (I-1)

The design of an infiltration trench is based on the textural class of the soils underlying the trench such that a feasible design is possible. The design of an infiltration trench is also based on the maximum allowable depth of the trench ( $d_{max}$ ). The maximum allowable depth should meet the following criteria:

$$d_{max} = \frac{fT_s}{n}$$

Where  $f$  is the final infiltration rate of the trench area in inches per hour,  $T_s$  is the maximum allowable storage time in hours, and  $n$  is the porosity ( $V_v/V_t$ ) of the stone reservoir.

An infiltration trench is sized to accept the design volume that enters the trench ( $V_w$ ) plus the volume of rain that falls on the surface of the trench ( $PA_t$ ) minus the exfiltration volume ( $fTA_t$ ) out of the bottom of the trench. Based on the SCS hydrograph analysis, the effective filling time for most infiltration trenches ( $T$ ) will generally be less than two hours. The volume of water that must be stored in the trench ( $V$ ) is defined as:

where  $P$  is the design rainfall event (ft), and  $A_t$  is the trench surface area (ft<sup>2</sup>). For most design

$$V = V_w + PA_t - fTA_t \quad (\text{Equation D - 13.1})$$

storm events, the volume of water due to rainfall on the surface area of the trench ( $PA_t$ ) is small when compared to the design volume ( $V_w$ ) of the trench and may be ignored with little loss in accuracy to the final design.

The volume of rainfall and runoff entering the trench can be defined in terms of trench geometry. The gross volume of the trench ( $V_t$ ) is equal to the ratio of the volume of water that must be stored ( $V$ ) to the porosity ( $n$ ) of the stone reservoir in the trench;  $V_t$  is also equal to the product of the depth ( $d_t$ ) and the surface area ( $A_t$ ):

$$V_t = \frac{V}{n} = d_t A_t n \quad (\text{Equation D - 13.2})$$

Combining equations D.13.1 and D.13.2 yields the following relationship:

$$d_t A_t n = V_w - fTA_t \quad (\text{Equation D - 13.3})$$

Because both dimensions of the trench are unknown, this equation may be rearranged to determine the area of the trench ( $A_t$ ) if the value of  $d_t$  were set based on either the location of the water table or the maximum allowable depth of the trench ( $d_{max}$ ):

$$A_t = \frac{V_w}{nd_t + fT}$$

### Procedures for Infiltration Trench Design

1. Determine the volume of water for storage using the methods for  $WQ_v$ ,  $Cp_v$ , or  $Q_p$  found in Chapter 2 and/or Appendix D.13.3.
2. Compute the maximum allowable trench depth ( $d_{max}$ ) from the feasibility equation,  $d_{max} = \frac{fT_s}{n}$ . Select the trench design depth ( $d_t$ ) based on the depth that is the required depth above the seasonal groundwater table, or a depth less than or equal to  $d_{max}$ , whichever results in the smaller depth.
3. Compute the trench surface area ( $A_t$ ) for the particular soil type using Equation D.13.3.

In the event that the sidewalls of the trench must be sloped for stability during construction, the surface dimensions of the trench should be based on the following equation:

$$A_t = (L - Zd_t)(W - Zd_t)$$

where  $L$  and  $W$  are the top length and width and  $Z:1$  is the trench side slope ratio. The design procedure would begin by selecting a top width ( $W$ ) that is greater than  $23Zd_t$  for a specified slope ( $Z$ ). The side slope ratio value will depend on the soil type and the depth of the trench.

$$L = Zd_t + \frac{A_t}{W - Zd_t}$$

The top length ( $L$ ) may then be determined as:

### D.13.2.3 Design of Infiltration Basins (I-2)

The design of an infiltration basin is based on the same soil textural properties and maximum allowable depth as the infiltration trench such that a feasible design is possible. However, because the infiltration basin uses an open area or shallow depression for storage, the maximum allowable depth ( $d_{max}$ ) should meet the following criteria:

$$d_{max} = f \times T_p$$

where  $f$  is the final infiltration rate of the trench area in inches per hour and  $T_p$  is the maximum allowable ponding time in hours.

An infiltration basin is sized to accept the design volume that enters the basin ( $V_w$ ) plus the volume of rain that falls on the surface of the basin ( $PA_b$ ) minus the exfiltration volume ( $fTA_b$ ) out of the bottom of the basin. Based on the SCS hydrograph analysis, the effective filling time for most infiltration basins will generally be less than two hours therefore use  $T = 2$  hours. The volume of water that must be stored in the trench ( $V$ ) is defined as

$$V = V_w + PA_b - fTA_b \quad (\text{Equation D - 13.4})$$

where  $P$  is the design rainfall event (ft), and  $A_b$  is the basin surface area (ft<sup>2</sup>). For most design storm events, the volume of water due to rainfall on the surface area of the basin ( $PA_b$ ) is small when compared to the design volume ( $V_w$ ) of the basin and may be ignored with little loss in accuracy to the final design.

The volume of rainfall and runoff entering the basin can be defined in terms of basin geometry. The geometry of a basin will generally be in the shape of an excavated trapezoid with specified side slopes. The volume of a trapezoidal shaped basin may be approximated by:

where  $A_t$  is the top surface area of the basin (ft<sup>2</sup>),  $A_b$  is the bottom surface area of the basin (ft<sup>2</sup>),

---

### D.13.6

$$A_b = \frac{2V_w - A_t d_b}{(d_b - 2P + 2fT)} \quad (\text{Equation D - 13.6})$$

and  $d_b$  is the basin depth (ft). By setting Equations D.13.4 and D.13.5 equal the following equation may be used to define the bottom area ( $A_b$ ):

If a rectilinear shape is used, the bottom length and width of the basin may be defined in terms of the top length and width as:

$$L_b = L_t - 2Zd_b$$

$$W_b = W_t - 2Zd_b$$

where  $Z$  is a specified side slope ratio ( $Z:1$ ). By substituting the above relationships for  $L_b$  and  $W_b$ , into Equation D.13.6, the following equation is derived for the basin top length:

$$L_t = \frac{V_w + Zd_b(W_t - 2Zd_b)}{W_t(d_b - P) - Zd_b^2} \quad \text{(Equation D - 13.7)}$$

### Procedures for Infiltration Basin Design

1. Determine the volume of water for storage using the methods for  $WQ_v$ ,  $Cp_v$ , or  $Q_p$  found in Chapter 2 and/or Appendix D.13.3.
2. Compute the maximum allowable basin depth ( $d_{max}$ ) from the feasibility equation,  $d_{max} = fT_p$ . Select the basin design depth ( $d_b$ ) based on the depth that is the required depth above the seasonal groundwater table, or a depth less than or equal to  $d_{max}$ , whichever results in the smaller depth.
3. Compute the basin surface area dimensions for the particular soil type using Equation D.13.6.

Note: If a rectilinear shape is used, the basin top length ( $L_t$ ) and width ( $W_t$ ) must be greater than  $2Zd_b$  for a feasible solution. If  $L_t$  and  $W_t$  are not greater than  $2Zd_b$  the bottom dimensions would be less than or equal to zero. In this case, the basin depth ( $d_b$ ) shall be reduced for a feasible solution.

### D.13.3 The Truncated Hydrograph Method for Stormwater Quantity Management

Most stormwater polices require that the peak discharge from the post-developed hydrograph for a selected return period(s) not exceed the peak discharge from the pre-developed hydrograph after development for stream channel erosion control and/or flood control purposes. In previous stormwater quantity management infiltration design methods, the difference between the pre-development and post-development runoff volumes was stored in the proposed infiltration structure. In most cases, this volume of runoff occurs prior to the actual hydrograph peak (see Figure D.13.2) and therefore actual peak discharge control is not provided. Therefore, when considering infiltration

practices for peak discharge or stormwater quantity control, the truncated hydrograph method should be used to determine the necessary infiltration storage volumes.

The pre-development and post-development peak discharges can be computed using standard SCS methodology (TR-55 Tabular or TR-20). The time ( $T_2$ ) at which the allowable discharge occurs on the receding limb of the post-development hydrograph, as shown in Figure D.13.1 is determined from the SCS methods. The volume of runoff under the post-development hydrograph and to the left of the allowable discharge at  $T_2$  is the design storage volume ( $V$ ).

The computed infiltration storage volume,  $V$ , may be adjusted to account for the volume of water which exfiltrates from the infiltration structure during the period of time required to fill the structure. The exfiltration volume ( $V_e$ ) is the product of the minimum soil infiltration rate (ft/hr), the filling time (hrs), and the surface area of the infiltration practice. The filling time ( $T_f$ ) of the infiltration practice may be determined directly from the post-development hydrograph as shown in Figure D.13.1.  $T_f$  is the difference between  $T_2$ , where the allowable discharge occurs on the recession limb and the time  $T_1$  where the discharge value on the rising of the hydrograph is equal to the minimum infiltration discharge. The minimum discharge is equal to the minimum soil infiltration rate (ft/sec) times the surface area (ft<sup>2</sup>) of the infiltration practice.



Figure D.13.2 Truncated Hydrograph Method

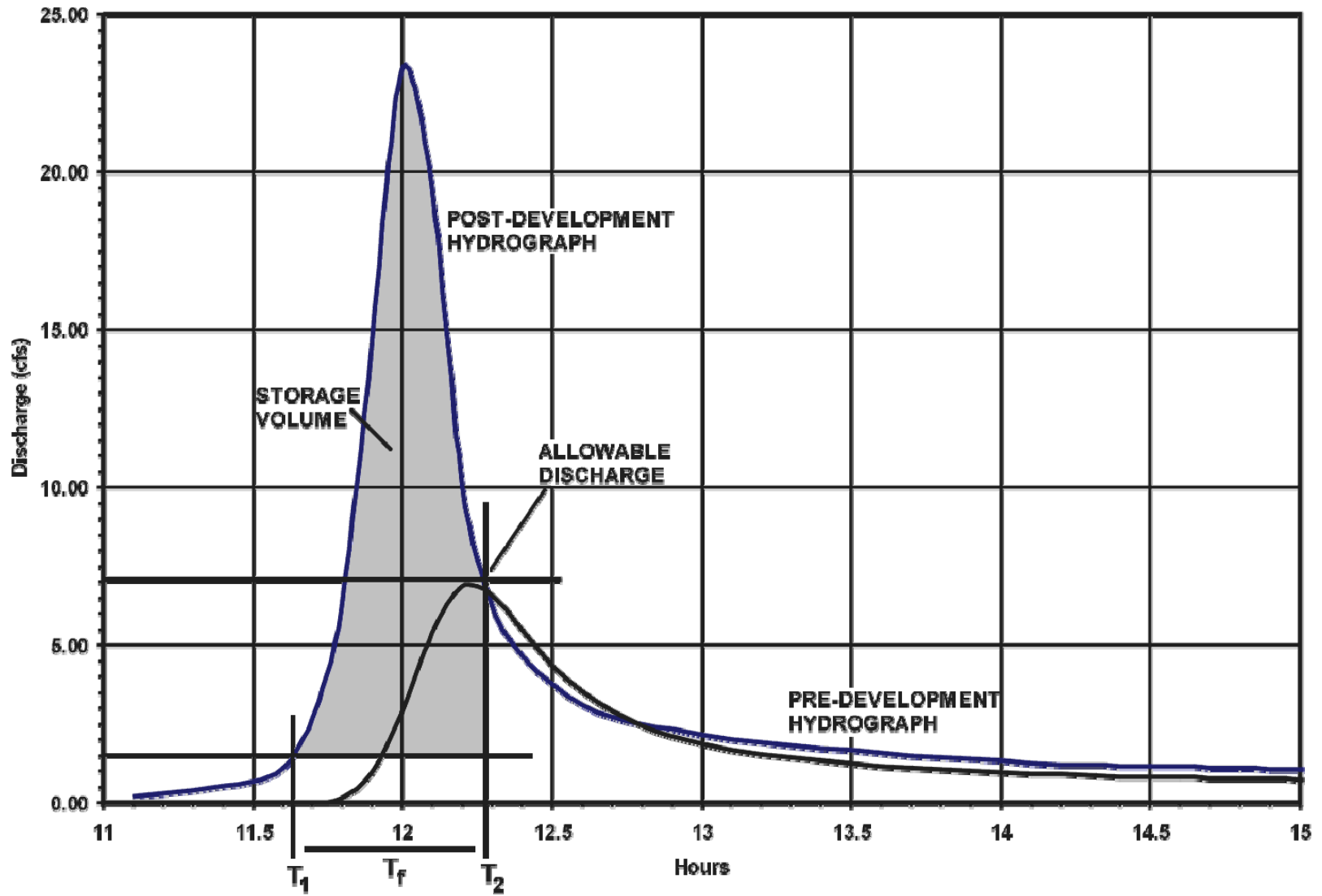

Appendix

**D.14**

**Eastern Shore (Delmarva) Dimensionless  
Hydrograph**

Figure D.14.1

SCS Graphical Method of Determining Peak Discharge ( $q_u$ ) in csm/in  
For Delmarva Peninsula

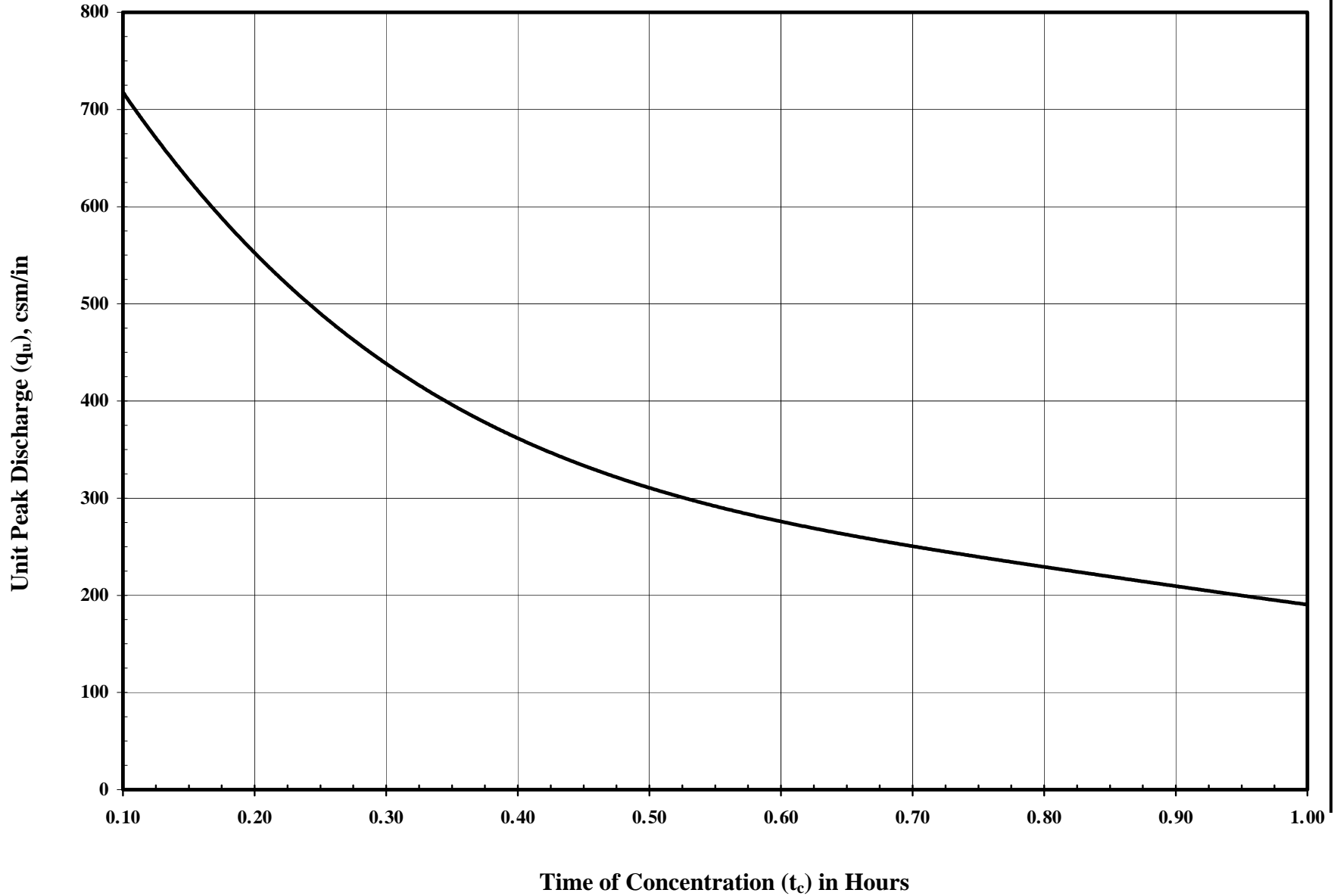

D-14.1

Appendix D.14 ..... Eastern Shore (Delmarva) Dimensionless Hydrograph

Figure D.14.2

Dimensionless Unit Hydrographs  
SCS (484) and Delmarva (284)

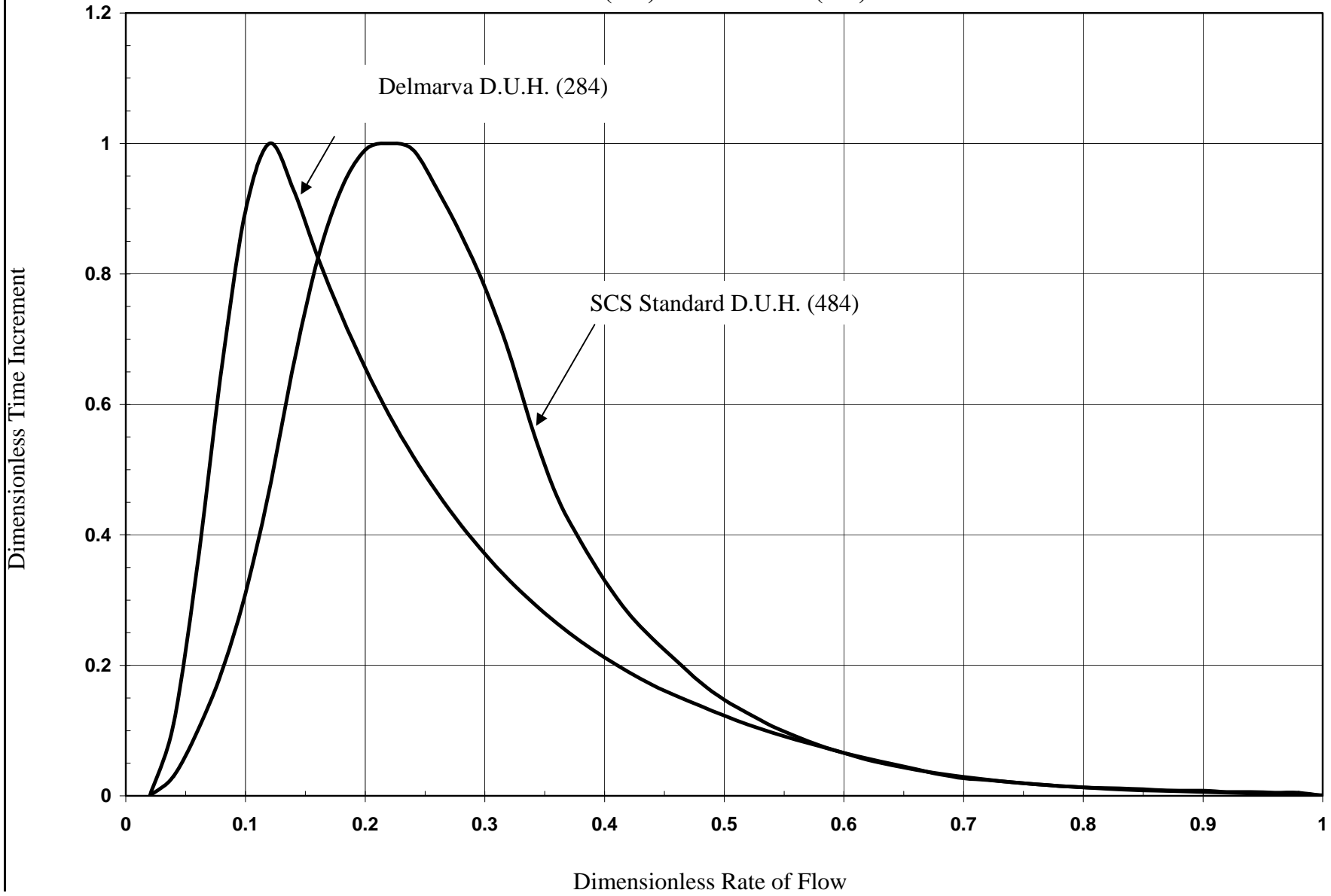

D-14.2

Dimensionless Time Increment

Dimensionless Rate of Flow

<b>Table D.14.1 Standard 24-Hour Dimensionless Unit Hydrograph</b>					
<b>Dimensionless Time Increment = 0.02</b>					
$\Delta t$	x.x0	x.x2	x.x4	x.x6	x.x8
0.0	0.0	0.0300	0.100	0.1900	0.31
0.1	0.47	0.66	0.82	0.93	0.99
0.2	1.00	0.99	0.93	0.86	0.78
0.3	0.68	0.56	0.46	0.39	0.33
0.4	0.28	0.241	0.207	0.174	0.147
0.5	0.126	0.107	0.091	0.077	0.066
0.6	0.055	0.047	0.04	0.034	0.029
0.7	0.025	0.021	0.018	0.015	0.013
0.8	0.011	0.009	0.008	0.007	0.006
0.9	0.005	0.004	0.003	0.002	0.001
1.0	0.0	0.0	0.0	0.0	0.0
<b>Computed Peak Rate Factor = 484.00</b>					

<b>Table D.14.2 24-Hour Dimensionless Unit Hydrograph for Use in the Delmarva Peninsula</b>					
<b>Dimensionless Time Increment = 0.02</b>					
$\Delta t$	x.x0	x.x2	x.x4	x.x6	x.x8
0.0	0.0	0.111	0.356	0.655	0.896
0.1	1.000	0.929	0.828	0.737	0.656
0.2	0.584	0.521	0.465	0.415	0.371
0.3	0.331	0.296	0.265	0.237	0.212
0.4	0.190	0.170	0.153	0.138	0.123
0.5	0.109	0.097	0.086	0.076	0.066
0.6	0.057	0.049	0.041	0.033	0.027
0.7	0.024	0.021	0.018	0.015	0.013
0.8	0.012	0.011	0.009	0.008	0.008
0.9	0.006	0.006	0.005	0.005	0.0
1.0	0.0	0.0	0.0	0.0	0.0
<b>Computed Peak Rate Factor = 284.00</b>					

**Appendix  
D.15**

**Miscellaneous MD SHA Design Charts  
for Determining Pipe Inlet Control**

FIGURE D.15.1 HEADWATER DEPTH FOR OVAL CONCRETE PIPE CULVERTS

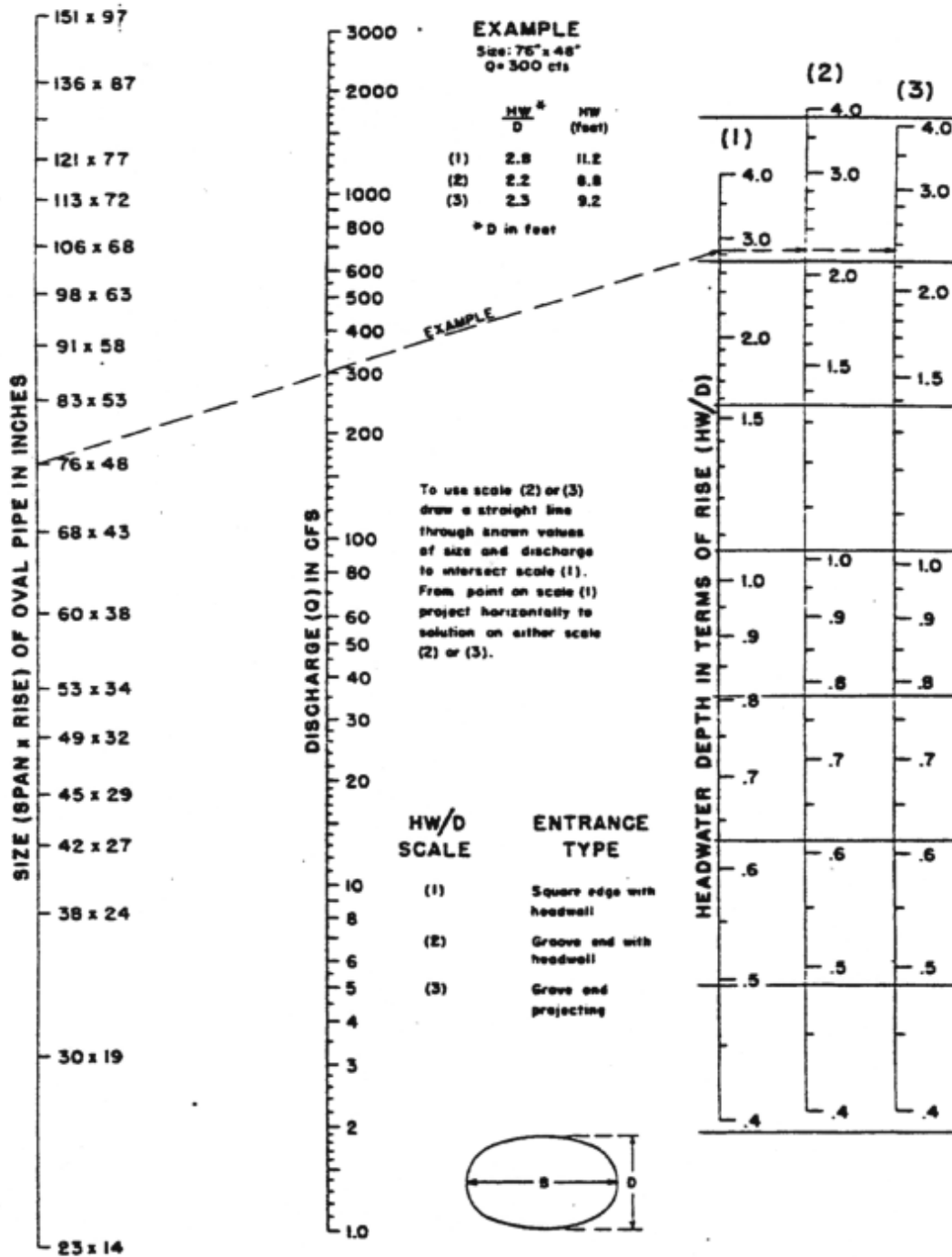

HEADWATER DEPTH FOR  
 OVAL CONCRETE PIPE CULVERTS  
 LONG AXIS HORIZONTAL  
 WITH INLET CONTROL

ADAPTED FROM MARYLAND STATE HIGHWAY ADMINISTRATION I/63 SHA-61.1-420.3-1.0

FIGURE D.15.2 HEADWATER DEPTH FOR CMP ARCH CULVERTS WITH INLET CONTROL

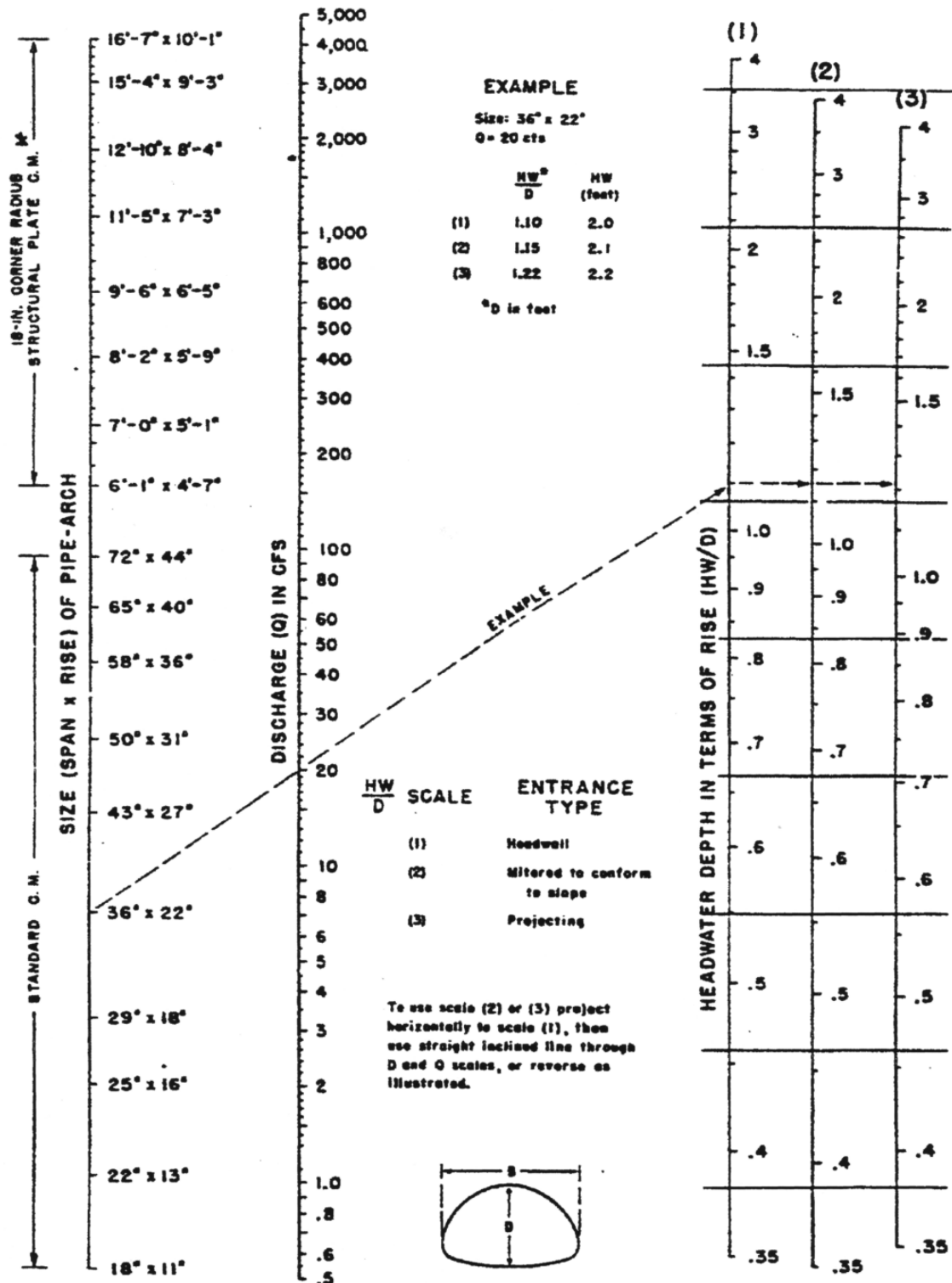

FOR ADDITIONAL SIZES THAT ARE NOT DIMENSIONED REFER TO CHARTS 442.00 AND 443.00

**HEADWATER DEPTH FOR C. M. PIPE-ARCH CULVERTS WITH INLET CONTROL**

ADAPTED FROM MARYLAND STATE HIGHWAY ADMINISTRATION I/63 SHA-61.1-420.2-2.0



FIGURE D.15.3 HEADWATER DEPTH FOR CMP CULVERTS WITH INLET CONTROL

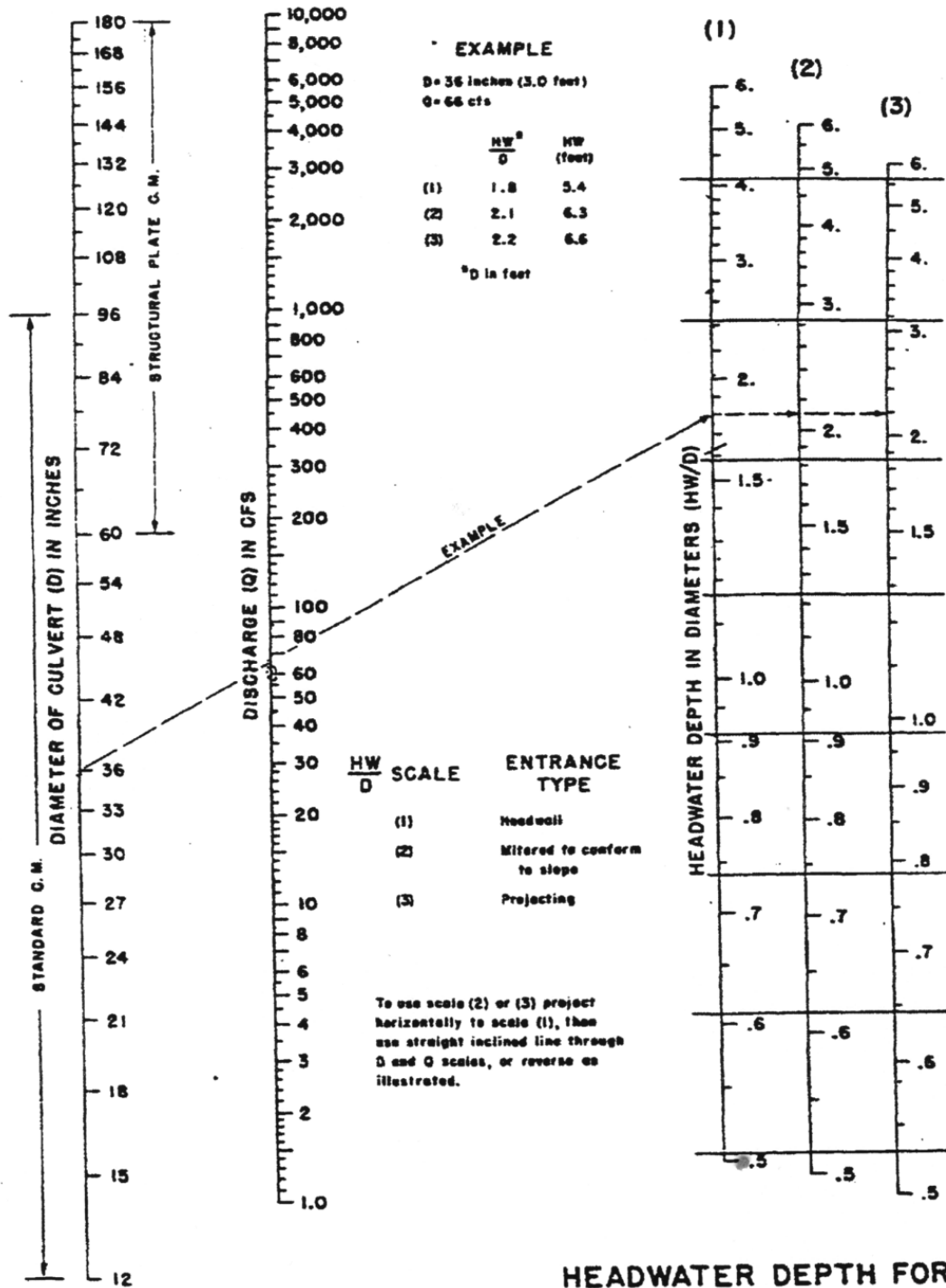

**HEADWATER DEPTH FOR  
 C. M. PIPE CULVERTS  
 WITH INLET CONTROL**

ADAPTED FROM MARYLAND STATE HIGHWAY ADMINISTRATION I/63 SHA-61.1-420.1-2.0

FIGURE D.15.4 HEADWATER DEPTH FOR CONCRETE PIPE CULVERTS WITH INLET CONTROL

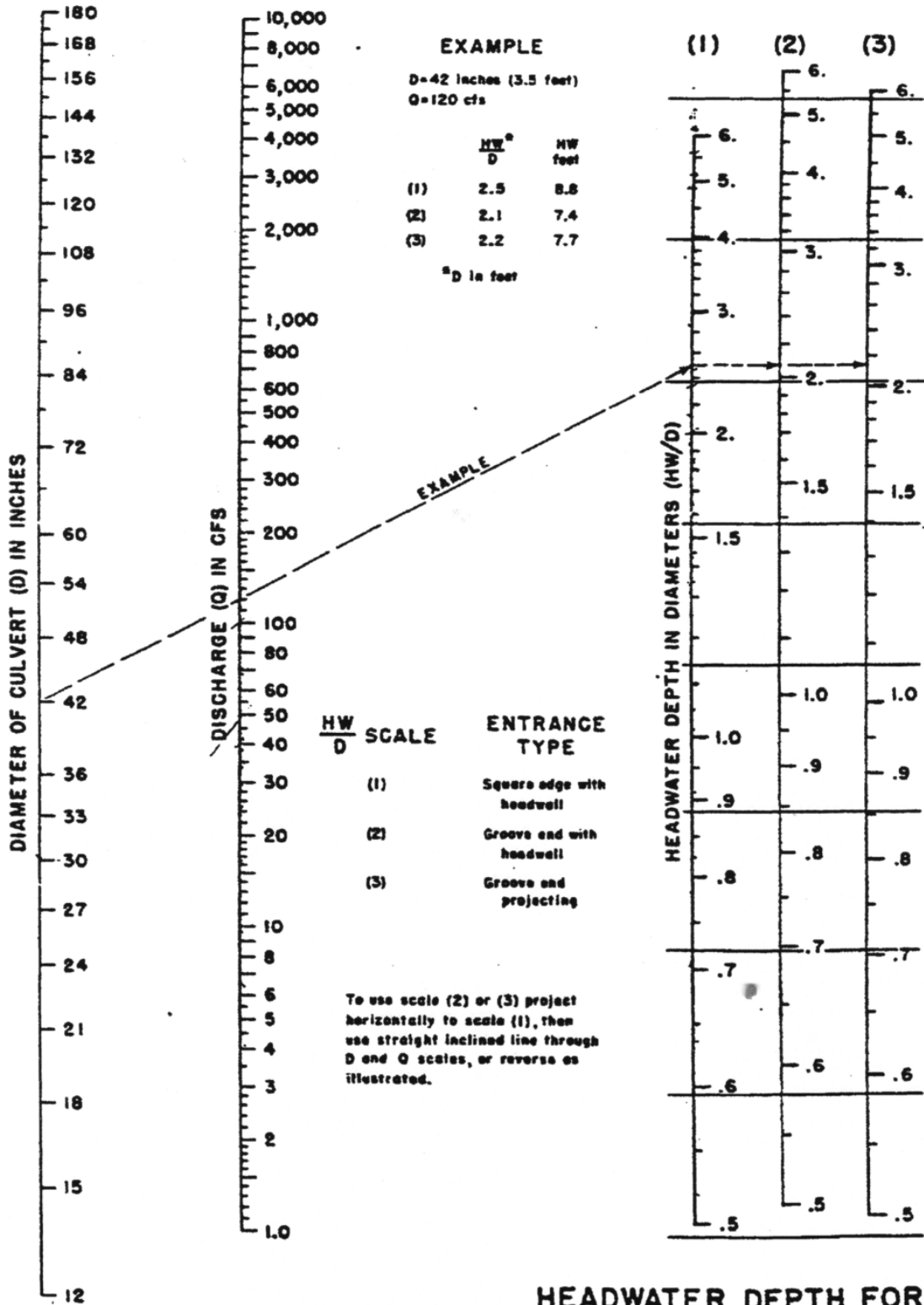

**HEADWATER DEPTH FOR CONCRETE PIPE CULVERTS WITH INLET CONTROL**

HEADWATER SCALES 283  
 REVISED MAY 1964

ADAPTED FROM MARYLAND STATE HIGHWAY ADMINISTRATION 5/64 SHA-61.1-420.1-1.0

**Appendix**

**E.1**

**Stormwater Credits for Innovative Site Planning**

### E.1.0 Stormwater Credits

In Maryland, there are many programs at both the State and local level that seek to minimize the impact of land development. Critical Areas, forest conservation, and local stream buffer requirements are designed to reduce nonpoint source pollution. Non-structural practices can play a significant role in reducing water quality impacts and are increasingly recognized as a critical feature of every stormwater BMP plan, particularly with respect to site design. In most cases, non-structural practices must be combined with structural practices to meet stormwater requirements. The key benefit of non-structural practices is that they can reduce the generation of stormwater from the site; thereby reducing the size and cost of stormwater storage. In addition, they can provide partial removal of many pollutants. Non-structural practices have been classified into six broad groups and are designed to mesh with existing state and local programs (e.g., forest conservation, stream buffers etc.). To promote greater use, a series of six stormwater credits are provided for designers that use these site planning techniques.

Credit 1.	Natural Area Conservation
Credit 2.	Disconnection of Rooftop Runoff
Credit 3.	Disconnection of Non Rooftop Runoff
Credit 4.	Sheet Flow to Buffers
Credit 5.	Open Channel Use
Credit 6.	Environmentally Sensitive Development

This chapter describes each of the credits for the six groups of non-structural practices, specifies minimum criteria to be eligible for the credit, and provides an example of how the credit is calculated. Designers should check with the appropriate approval authority to ensure that the credit is applicable to their jurisdiction. Clearly both of the site designs used to illustrate the credits could be more creative to provide more non-structural opportunities.

In general, the stormwater sizing criteria provide a strong incentive to reduce impervious cover at development sites (e.g.,  $Re_v$ ,  $WQ_v$ ,  $Cp_v$  or  $Qp$  and  $Qf$ ). Storage requirements for all five stormwater sizing criteria are directly related to impervious cover. Thus, significant reductions in impervious cover result in smaller required storage volumes and, consequently, lower BMP construction costs.

These and other site design techniques can help to reduce impervious cover, and consequently, the stormwater treatment volume needed at a site. The techniques presented in this chapter are considered options to be used by the designer to help reduce the need for stormwater BMP storage capacity. Due to local safety codes, soil conditions, and topography, some of these site design features will be restricted. Designers are encouraged to consult with the appropriate approval authority to determine restrictions on non-structural strategies.

NOTE: This chapter contains archived material and is presented here for historical purposes only.
---

These credits are an integral part of a project’s overall stormwater management plan and BMP storage volume calculation. Therefore, use of these credits shall be documented at the initial (concept) design stage, documented with submission of final grading plans, and verified with “as-built” certifications. If a planned credit is not implemented, then BMP volumes shall be increased appropriately to meet  $Re_v$ ,  $WQ_v$ ,  $Cp_v$ , and  $Q_p$  where applicable.

**Table E.1.1** Summary of Stormwater Credits

<b>Stormwater Credit</b>	<b><math>WQ_v</math></b>	<b><math>Re_v</math></b>	<b><math>Cp_v</math> or <math>Q_p</math></b>
<b>Natural Area Conservation</b>	Reduce Site Area	No credit. Use as receiving area w/Percent Area Method.	Forest/meadow CN for natural areas
<b>Disconnection of Rooftop Runoff</b>	Reduced $R_v$	No credit. Use with Percent Area Method.	Longer $t_c$ (increased flow path). CN credit.
<b>Disconnection of Non-Rooftop Runoff</b>	Reduced $R_v$	No credit. Use with Percent Area Method.	Longer $t_c$ (increased flow path) CN credit
<b>Sheet Flow to Buffers</b>	Subtract contributing site area to BMP	Reduced $Re_v$	CN credit
<b>Open Channel Use</b>	May meet $WQ_v$	Meets $Re_v$	Longer $t_c$ (increased flow path) No CN credit
<b>Environmentally Sensitive Development</b>	Meets $WQ_v$	Meets $Re_v$	No CN credit $t_c$ may increase

### Section E.1.1 Natural Area Conservation Credit

#### Natural Area Conservation Credit

A stormwater credit is given when natural areas are conserved at development sites, thereby retaining pre development hydrologic and water quality characteristics. A simple  $WQ_v$  credit is granted for all conservation areas permanently protected under conservation easements or other locally acceptable means. Examples of natural area conservation include:

- forest retention areas
- non-tidal wetlands and associated buffers
- other lands in protective easement (floodplains, open space, steep slopes)
- stream systems

Under the credit, a designer can subtract conservation areas from total site area when computing the water quality volume. The volumetric runoff coefficient,  $R_v$ , is still calculated based on the percent impervious cover for the entire site.

As an additional incentive, the post development curve number (CN) used to compute the  $Cp_v$  or  $Qp_2$ , and  $Qp_{10}$  for all natural areas protected by conservation easements can be assumed to be woods in good condition when calculating the total site CN.

As an example, the required  $WQ_v$  for a ten acre site with three acres of impervious area and three acres of protected conservation area before the credit would be:

$$WQ_v = [(P)(R_v)(A)]/12; \text{ where } P= 1", R_v = 0.05+0.009(30\%)$$
$$WQ_v = [(1") (0.32)(10 \text{ acres})]/12 = 0.266 \text{ acre-feet.}$$

Under the credit, three acres of conservation are subtracted from total site area, which yields a smaller storage volume:

$$WQ_v = [(P)(R_v)(A)]/12; \text{ where } P=1", R_v=0.05+0.009(30\%)$$
$$WQ_v = [(1")(0.32)(10-3 \text{ acres})]/12 = 0.187 \text{ acre-feet.}$$

The recharge requirement ( $Re_v$ ) is not reduced using this credit.

### **Criteria for Natural Area Credit**

To receive the credit, the proposed conservation area:

- *Shall not be disturbed during project construction (e.g., cleared or graded) except for temporary impacts associated with incidental utility construction or mitigation and afforestation projects,*
- *Shall be protected by having the limits of disturbance clearly shown on all construction drawings and delimited in the field except as provided for above,*
- *Shall be located within an acceptable conservation easement or other enforceable instrument that ensures perpetual protection of the proposed area. The easement must clearly specify how the natural area vegetation shall be managed and boundaries will be marked [Note: managed turf (e.g., playgrounds, regularly maintained open areas) is not an acceptable form of vegetation management], and*
- *Shall be located on the development project.*

**Example of Calculating Natural Area Credit**

Site Data - 51 Single Family Lots  
 Area = 38 ac.  
 Conservation Area = 7.0 ac  
 Impervious Area = 13.8 ac  
 $R_v = .38, P = 0.9$   
 Post dev. CN = 78  
 Original  $WQ_v = 1.08$  ac-ft.  
 Original  $Re_v = .25$  ac-ft.  
 Original  $Cp_v = 1.65$  ac-ft.  
 Original  $Q_{p10} = 2.83$  ac-ft.

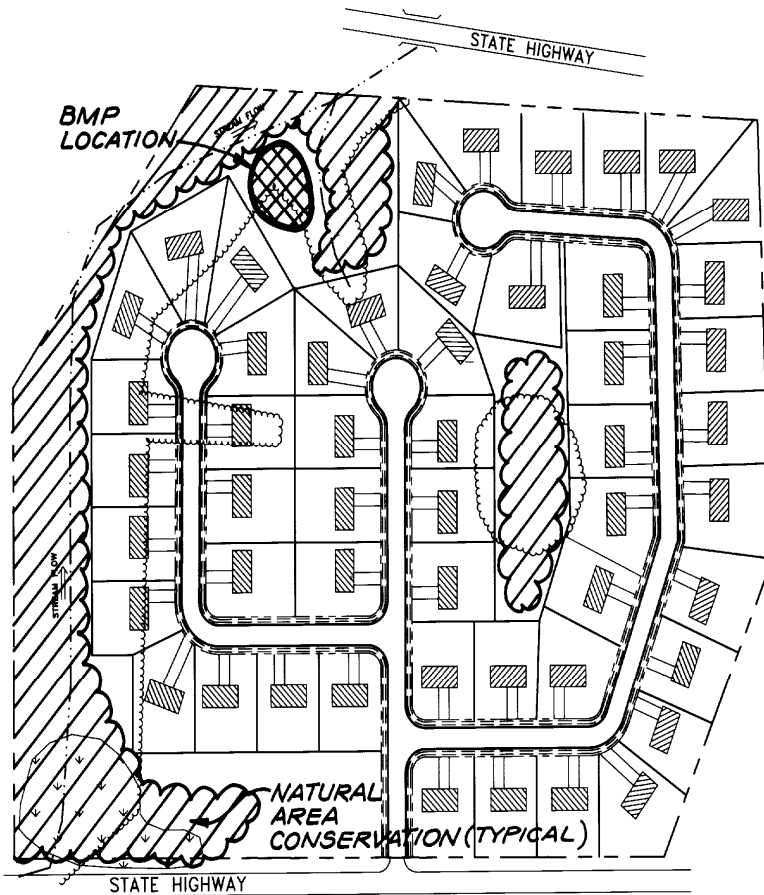

**Computation of Stormwater Credits**

$$\begin{aligned}
 WQ_v &= [(P)(R_v)(A)]/12 \\
 &= [(0.9)(.38)(38.0 - 7.0 \text{ ac.})]/12 \\
 &= 0.89 \text{ ac-ft}
 \end{aligned}$$

$Re_v$  = Same as original  
 (However, area draining to Natural Area may used with the Percent Area Method)

$Cp_v$  and  $Q_{p10}$  (total site): CN reduced from 78 to 75



**Section E.1.2 Disconnection of Rooftop Runoff Credit****Disconnection of Rooftop Runoff Credit**

A credit is given when rooftop runoff is disconnected and then directed to a pervious area where it can either infiltrate into the soil or filter over it. The credit is typically obtained by grading the site to promote overland filtering or by providing bioretention areas on single family residential lots.

If a rooftop is adequately disconnected, the disconnected impervious area may be deducted from total impervious cover (therefore reducing  $WQ_v$ ). In addition, disconnected rooftops can be used to meet the  $Re_v$  requirement as a non-structural practice using the percent area method (see Chapter 2).

Post development CN's for disconnected rooftop areas used to compute  $Cp_v$  and  $Qp$  can be assumed to be woods in good condition.

**Criteria for Disconnection of Rooftop Runoff Credit**

The credit is subject to the following restrictions:

- *Rooftop cannot be within a designated hotspot,*
- *Disconnection shall cause no basement seepage,*
- *The contributing area of rooftop to each disconnected discharge shall be 500 square feet or less,*
- *The length of the "disconnection" shall be 75' or greater, or compensated using Table E.1.2,*
- *Dry wells, french drains, rain gardens, or other similar storage devices may be utilized to compensate for areas with disconnection lengths less than 75 feet. (See Table E.1.2 and Figure E.1.1, dry wells are prohibited in "D" soils),*
- *In residential development applications, disconnections will only be credited for lot sizes greater than 6000 sq. ft.,*
- *The entire vegetative "disconnection" shall be on an average slope of 5% or less,*
- *The disconnection must drain continuously through a vegetated channel, swale, or through a filter strip to the property line or BMP,*
- *Downspouts must be at least 10 feet away from the nearest impervious surface to discourage "re-connections", and*
- *For those rooftops draining directly to a buffer, only the rooftop disconnection credit or the buffer credit may be used, not both.*

**Figure E.1.1** Schematic of Dry Well

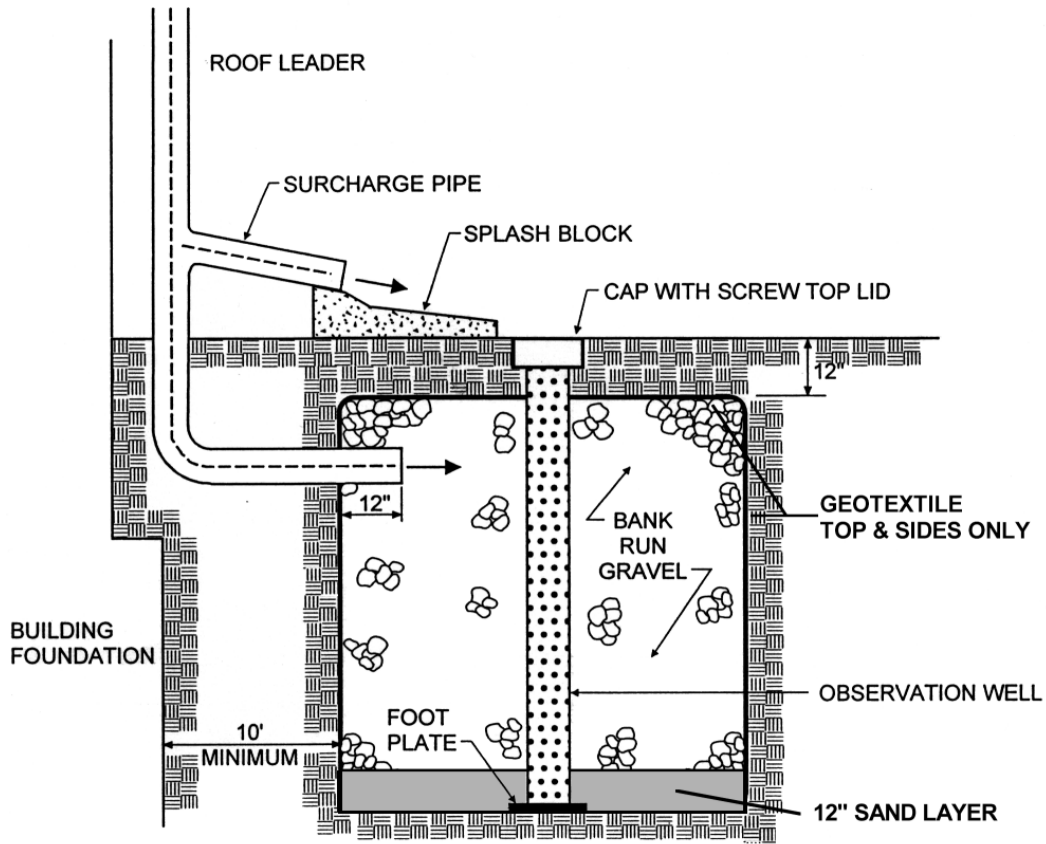

**Table E.1.2** Rooftop Disconnection Compensation Storage Volume Requirements  
(Per Disconnection Using Drywells, Raingardens, etc.)

Disconnection Length Provided	0 - 14 ft.	15 - 29 ft.	30 - 44 ft.	45 - 59 ft.	60 - 74 ft.	≥ 75 ft.
% WQ <sub>v</sub> Treated by Disconnect	0%	20%	40%	60%	80%	100%
% WQ <sub>v</sub> Treated by Storage	100%	80%	60%	40%	20%	0%
Max. Storage Volume* (Eastern Rainfall Zone)	40 cu-ft.	32 cu-ft.	24 cu-ft.	16 cu-ft.	8 cu-ft.	0 cu-ft.
Max. Storage Volume* (Western Rainfall Zone)	36 cu-ft.	28.8 cu-ft.	21.6 cu-ft.	14.4 cu-ft.	7.2 cu-ft.	0 cu-ft.

\*Assuming 500 square feet roof area to each downspout.

**Example of Using the Rooftop Disconnection Credit**

Site Data - 51 Single Family Lots  
 Area = 38 ac., 1/2 acre lots  
 Original Impervious Area = 13.80 ac.  
 Original  $R_v = .38$   
 Post dev. CN = 78  
 # of Disconnected Rooftops = 22  
 Original  $WQ_v = 1.08$  ac-ft  
 Original  $Re_v = 0.25$  ac-ft  
 Original  $Cp_v = 1.65$  ac-ft  
 Original  $Qp_v = 2.83$  ac-ft

60% B Soils  
 40% C Soils  
 Composite  $S=0.208$  (20.8%)

22 Lots Disconnected w/5  
 Downspouts each.  
 $\therefore$  2500 sq. ft. each lot

Net impervious area reduction =  
 $(22)(2500)/43560 = 1.3$  ac

Net Impervious Area =  
 $13.8 - 1.3 = 12.5$  acres

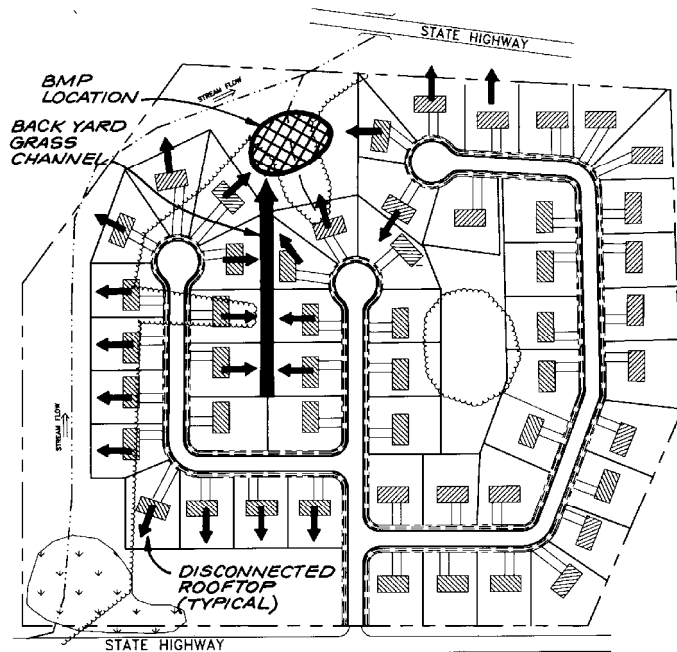

**Computation of Stormwater Credit:**

New  $R_v = 0.05 + .009 (12.5 \text{ ac}/38 \text{ ac}) = .35$   
 $\therefore WQ_v = [(0.9)(.35)(38 \text{ ac})]12 = 1.00$  ac-ft.

**Required  $Re_v$  (Percent Area Method)**

$Re_v = 20.8\% \times 13.8 \text{ ac.} = 2.87$  acres

$Re_v$  treated by disconnection = 1.3 acres

$Re_v$  remaining for treatment = 1.57 acres non structurally or 0.14 acre-feet structurally

$Cp_v$  and  $Qp$  (total site): CN reduced from 78 to 76

### Section E.1.3 Disconnection of Non Rooftop Runoff Credit

#### Disconnection of Non Rooftop Runoff Credit

Credit is given for practices that disconnect surface impervious cover runoff by directing it to pervious areas where it is either infiltrated into the soil or filtered (by overland flow). This credit can be obtained by grading the site to promote overland vegetative filtering or providing bioretention areas on single family residential lots.

These "disconnected" areas can be subtracted from the impervious area when computing  $WQ_v$ . In addition, disconnected surface impervious cover can be used to meet the  $Re_v$  requirement as a non-structural practice using the percent area method (See Chapter 2).

#### Criteria for Disconnection of Non Rooftop Runoff Credit

The credit is subject to the following restrictions:

- *Runoff cannot come from a designated hotspot,*
- *The maximum contributing impervious flow path length shall be 75 feet,*
- *The disconnection shall drain continuously through a vegetated channel, swale, or filter strip to the property line or BMP,*
- *The length of the "disconnection" must be equal to or greater than the contributing length,*
- *The entire vegetative "disconnection" shall be on an average slope of 5% or less,*
- *The surface impervious area to any one discharge location cannot exceed 1,000 ft<sup>2</sup>.*
- *Disconnections are encouraged on relatively permeable soils (HSG's A and B),*
- *If the site cannot meet the required disconnect length, a spreading device, such as a french drain, rain garden, gravel trench or other storage device may be needed for compensation, and*
- *For those areas draining directly to a buffer, only the non rooftop disconnection credit or the stream buffer credit can be used, not both.*

<b>Example of Calculating the Non Rooftop Disconnection Credit</b>	
<p>Site Data -Community Center                      Area = 3.0 ac                      Original Impervious Area = 1.9 ac. = 63.3%                      Original <math>R_v = .62</math>                      Post dev. CN = 83                      B Soils, <math>S = 0.26</math>                      Original <math>WQ_v = 6752 \text{ ft}^3</math>                      Original <math>Re_v = 1688 \text{ ft}^3</math>                      Original <math>Cp_v = \text{N/A}</math>                      Original <math>Q_{p2} = 10,630 \text{ ft}^3</math></p> <p>0.33 ac of surface imperviousness disconnected</p> <p>Net impervious area reduction  <math>1.9 - 0.33 = 1.57 \text{ ac.}</math></p>	<p>The diagram illustrates a site plan for a community center. A dashed line indicates the site boundary. A 'COUNTY ROAD' is shown on the left with a 'CULVERT' crossing it. A 'STRUCTURAL BMP' is located near the road. A 'DISCONNECTED IMPERVIOUS SURFACE' is shown as a hatched area. An 'EX. TREELINE' is shown on the right. A 'DRY SWALE OR GRASS CHANNEL' is shown at the bottom right. A 'USE I STREAM' is also indicated. Distances of 125 and 150 are marked along the swale/channel. A 'TOTAL IMPERVIOUS AREA = 1.9 ac' is labeled within the site boundary.</p>
<p>Computation of Stormwater Credit:</p> <p>New <math>R_v = 0.05 + .009 (1.57 \text{ ac}/3.0 \text{ ac}) = .52</math>  <math>\therefore WQ_v = [(1.0)(0.52)(3.0 \text{ ac})]/12 = 0.13 \text{ ac-ft (5662.8 cf)}</math></p> <p>Required <math>Re_v</math> (Percent area method)  <math>Re_v = (S)(A_i) = (0.26)(1.9 \text{ ac.}) = 0.49 \text{ acres}</math>  <math>Re_v</math> treated by disconnection = 0.33 acres  <math>Re_v</math> remaining for treatment = 0.16 acres non structurally or 551.2 cf structurally</p> <p><math>Cp_v</math> and <math>Q_p</math> Post developed CN may be reduced</p>	

**Section E.1.4 Sheetflow to Buffer Credit****Sheetflow to Buffer Credit**

This credit is given when stormwater runoff is effectively treated by a natural buffer to a stream or forested area. Effective treatment is achieved when pervious and impervious area runoff is discharged to a grass or forested buffer through overland flow. The use of a filter strip is also recommended to treat overland flow in the green space of a development site.

The credits include:

1. The area draining by sheet flow to a buffer is subtracted from the total site area in the  $WQ_v$  calculation.
2. The area draining to the buffer contributes to the recharge requirement,  $Re_v$ .
3. A *wooded* CN can be used for the contributing area if it drains to a forested buffer.

**Criteria for Sheetflow to Buffer Credit**

The credit is subject to the following conditions:

- *The minimum buffer width shall be 50 feet as measured from bankfull elevation or centerline of the buffer,*
- *The maximum contributing length shall be 150 feet for pervious surfaces and 75 feet for impervious surfaces,*
- *Runoff shall enter the buffer as sheet flow. Either the average contributing overland slope shall be 5.0% or less, or a level spreading device shall be used where sheet flow can no longer be maintained (see Detail No. 9 in Appendix D.8),*
- *Not applicable if rooftop or non rooftop disconnection is already provided (see Credits 2 & 3),*
- *Buffers shall remain unmanaged other than routine debris removal, and*
- *Shall be protected by an acceptable conservation easement or other enforceable instrument that ensures perpetual protection of the proposed area. The easement must clearly specify how the natural area vegetation shall be managed and boundaries will be marked [Note: managed turf (e.g., playgrounds, regularly maintained open areas) is not an acceptable form of vegetation management].*

Figure E.1.2 illustrates how a buffer or filter strip can be used to treat stormwater from adjacent pervious and impervious areas.

**Figure E.1.2** Example of Sheetflow to Buffer Credit

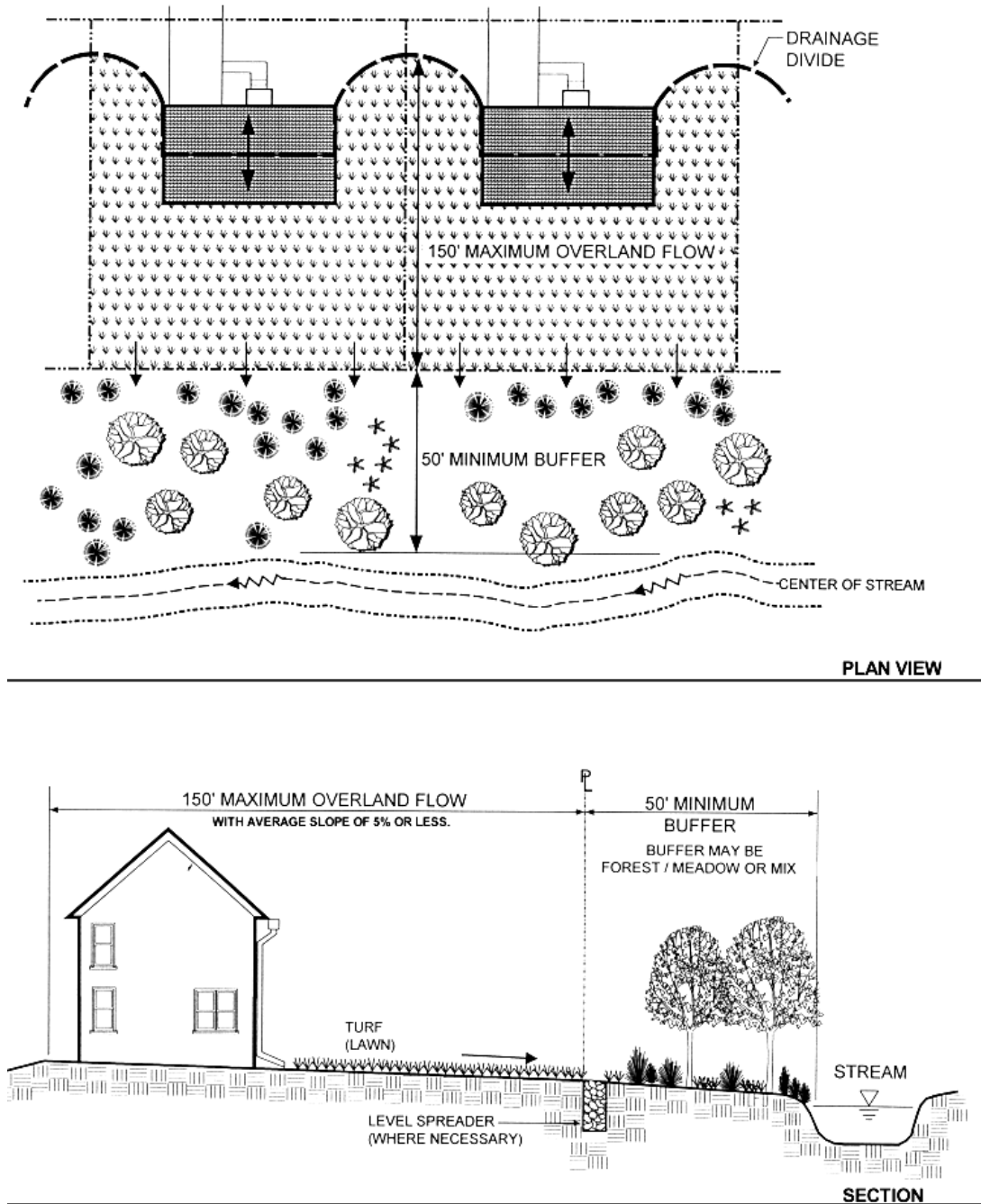

**Example of Using the Sheetflow to Buffer Credit**

Site Data - 51 Single Family  
 Area = 38.0 ac  
 Original Impervious Area =  
 13.8 ac = 36.3%  
 Original  $R_v = .38$   
 Post-dev. CN = 78

Original  $WQ_v = 1.08$  ac-ft  
 Original  $Re_v = 0.24$  ac-ft  
 Original  $Cp_v = 1.65$  ac-ft  
 Original  $Qp_v = 2.83$  ac-ft

Credit  
 5.0 ac draining to  
 buffer/filter strip  
 Rooftops represent 3% of  
 site imperviousness = 0.41  
 acres

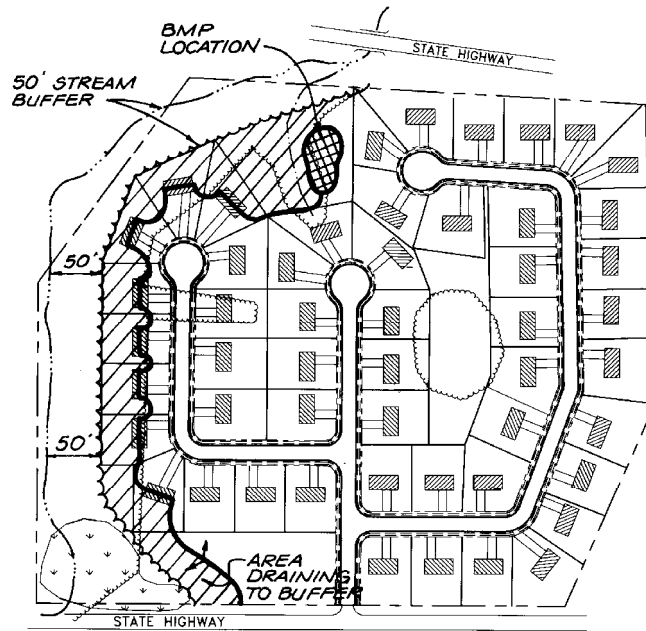

**Computation of Stormwater Credits**

New drainage area = 38 ac.- 5 ac. = 33.0 acres  
 $R_v$  remains unchanged to BMP;  $R_v = 0.05 + 0.009(36.3) = 0.38$

$$WQ_v = [(P)(R_v)(A)]/12$$

$$= [(0.9)(0.38)(33.0 \text{ ac.})]/12$$

$$= 0.94 \text{ ac-ft}$$

**Required  $Re_v$  (Percent Area Method)**

$Re_v = 20.8\% \times 13.8 \text{ ac.} = 2.87 \text{ acres}$   
 $Re_v$  treated by disconnection = 0.41 acres  
 $Re_v$  remaining for treatment = 2.46 acres non structurally or 0.214 ac-ft structurally

$Cp_v$  and  $Qp_v$  (total site): CN is reduced slightly.



### Section E.1.5 Grass Channel Credit

Grass Channel Credit (in lieu of Curb and Gutter):

Credit may be given when open grass channels are used to reduce the volume of runoff and pollutants during smaller storms (e.g., < 1 inch). The schematic of the grass channel is provided in Figure 5.3.

Use of a grass channel will automatically meet the  $Re_v$  for impervious areas draining into the channel. However,  $Re_v$  for impervious areas not draining to grass channels must still be addressed. If designed according to the following criteria, the grass channel will meet the  $WQ_v$  as well.

CNs for channel protection or peak flow control ( $Cp_v$  or  $Q_p$ ) will not change.

#### Criteria for the Grass Channel Credit

The  $WQ_v$  credit is obtained if a grass channel meets the following criteria:

- *The maximum flow velocity for runoff from the one-inch rainfall shall be less than or equal to 1.0 fps (see Appendix D.10 for methodology to compute flowrate),*
- *The maximum flow velocity for runoff from the ten-year design event shall be non erosive,*
- *The bottom width shall be 2 feet minimum and 8 feet maximum,*
- *The side slopes shall be 3:1 or flatter,*
- *The channel slope shall be less than or equal to 4.0%, and*
- *Not applicable if rooftop disconnection is already provided (see Credit 2).*

An example of a grass channel is provided in Figure E.1.3.

**Figure E.1.3** Example of Grass Channel

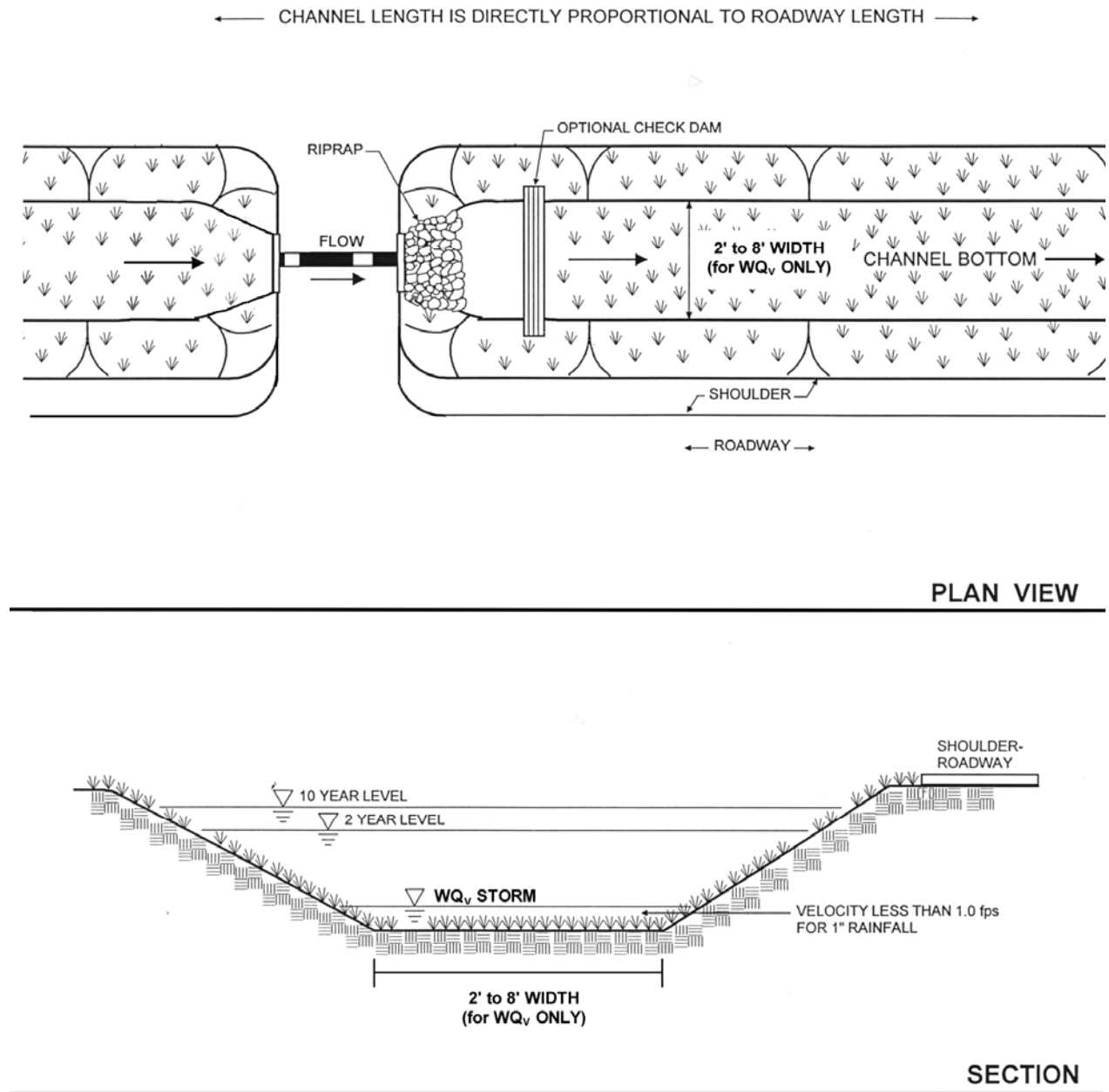

**Example of Grass Channel Credit**

Site Data - 51 Single Family Residences

Area = 38.0 ac

Original Impervious Area = 13.8 = 36.3%

$R_v = .38$

CN = 78

Original  $WQ_v = 1.08$  ac-ft

Original  $Re_v = 0.25$  ac-ft

Original  $Cp_v = 1.65$  ac-ft

Original  $Qp_v = 2.83$  ac-ft

Credit

12.5 acres meet grass channel criteria

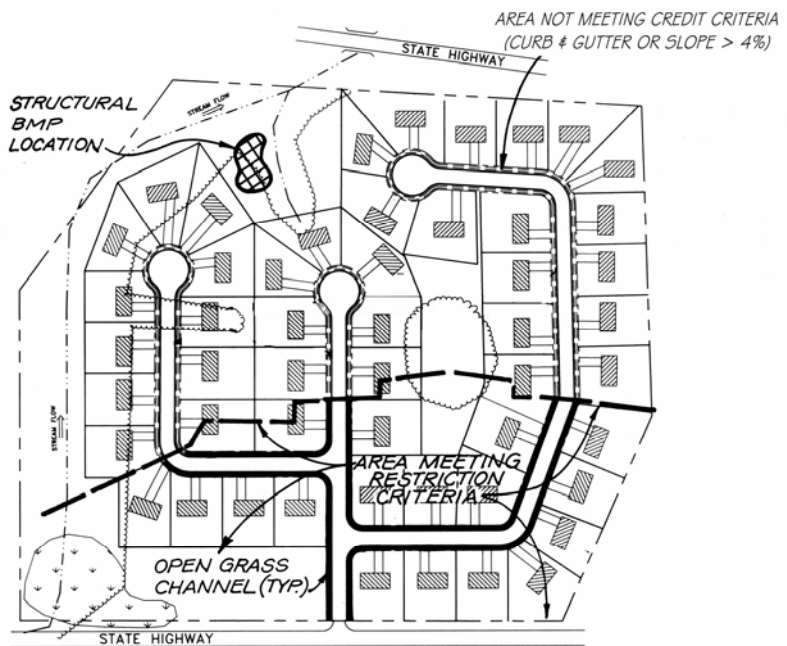

**Computation of Stormwater Credits**

New  $WQ_v$  Area = 38 ac - 12.5 ac = 25.5 ac

$$WQ_v = [(0.9)(0.38)(25.5 \text{ ac.})]/12 = 0.74 \text{ ac-ft}$$

Required  $Re_v$  (Percent Area Method)

$$Re_v = 20.8\% \times 13.8 \text{ ac.} = 2.87 \text{ acres}$$

4.5 acres of imperviousness lie within area drained by grass channels, and

4.5 acres > 2.87 acres

$\therefore Re_v$  requirement is met.

$Cp_v$  and  $Qp_v$ : No change

### Section E.1.6 Environmentally Sensitive Development Credit

#### Environmentally Sensitive Development

Credit is given when a group of environmental site design techniques are applied to low density or residential development. The credit eliminates the need for structural practices to treat both the  $Re_v$  and  $WQ_v$  and is intended for use on large lots.

#### Criteria for Environmentally Sensitive Development Credit

These criteria can be met without the use of structural practices in certain low density residential developments when the following conditions are met:

##### For Single Lot Development:

- *total site impervious cover is less than 15%,*
- *lot size shall be at least two acres,*
- *rooftop runoff is disconnected in accordance with the criteria outlined in Section E.1.2, and*
- *grass channels are used to convey runoff versus curb and gutter.*

##### For Multiple Lot Development:

- *total site impervious cover is less than 15%,*
- *lot size shall be at least two acres if clustering techniques are not used,*
- *if clustering techniques are used, the average lot size shall not be greater than 50% of the minimum lot size as identified in the appropriate local zoning ordinance and shall be at least one half acre,*
- *rooftop runoff is disconnected in accordance with the criteria outlined in Section E.1.2,*
- *grass channels are used to convey runoff versus curb and gutter,*
- *a minimum of 25% of the site is protected in natural conservation areas (by permanent easement or other similar measure), and*
- *the design shall address stormwater ( $Re_v$ ,  $WQ_v$ ,  $Cp_v$ , and/or  $Qp_{10}$ ) for all roadway and connected impervious surfaces.*

<b>Example of Environmentally Sensitive Development</b>	
<p>Site Data - 1 Single Family Lot                      Area = 2.5 ac                      Conservation Area = 0.6 ac                      Impervious Area = .35 ac (includes adjacent road surface) = 14%                      B soils                      Eastern Rainfall Zone for WQ<sub>v</sub>  <math>R_v = 0.05 + 0.009(14) = .18</math>                      CN = 65</p> <p>WQ<sub>v</sub> : Use P=0.2 as I &lt; 15%  <math>WQ_v = [(0.2)(A)]/12</math>  <math>= [(0.2)(2.5)]/12 \times (43560 \text{ ft}^2/\text{ac.})</math>  <math>= 1,815 \text{ ft}^3</math></p> <p>Re<sub>v</sub> = [(S)(R<sub>v</sub>)(A)]/12  <math>= [(0.26)(0.18)(2.5)]/12 \times (43,560 \text{ ft}^2/\text{ac.})</math>  <math>= 424.7 \text{ ft}^3</math></p>	<p>The diagram illustrates a site plan for a single-family lot. A hatched triangular area at the top is labeled 'NATURAL CONSERVATION AREA'. Below it, a house and driveway are shown. A note states: 'HOUSE &amp; DRIVE, SIDEWALKS/DECK, &amp; PORCH ≤ 15% OF SITE IMPERVIOUSNESS'. Roof drains are shown as disconnected lines leading to a 'DRY WELL'. A 'GRASS CHANNEL' is shown at the bottom, adjacent to an 'OPEN SECTION ROAD'.</p>
<p>Computation of Stormwater Credits:</p> <p>WQ<sub>v</sub> is met by site design                      Re<sub>v</sub> is met by site design                      Cp<sub>v</sub> and Q<sub>p</sub>: No change in CN, t<sub>c</sub> may be longer which would reduce Q<sub>p</sub> requirements</p>	

**Section E.1.7 Dealing with Multiple Credits**

Site designers are encouraged to utilize as many credits as they can on a site. Greater reductions in stormwater storage volumes can be achieved when many credits are combined (e.g., disconnecting rooftops and protecting natural conservation areas). However, credits cannot be claimed twice for an identical area of the site (e.g. claiming credit for stream buffers and disconnecting rooftops over the same site area).

**Section E.1. 8 Other Strategies to Reduce Impervious Cover**

Definition: Site planning practices that reduce the creation of impervious area in new residential and commercial development and therefore reduce the  $WQ_v$  for the site.

Examples of progressive site design practices that minimize the creation of impervious cover include:

- Narrower residential road sections
- Shorter road lengths
- Smaller turnarounds and cul-de-sac radii
- Permeable spill-over parking areas
- Smaller parking demand ratios
- Smaller parking stalls
- Angled one way parking
- Subdivisions with open space
- Smaller front yard setbacks
- Shared parking and driveways
- Narrower sidewalks

It should be noted that most site designers may have little ability to control these requirements, which are typically enshrined in local subdivision, parking and/or street codes.

Where these techniques are employed, it may be possible to reduce stormwater storage volumes. For example, because the  $WQ_v$  is directly based on impervious cover, a reduction in impervious cover reduces  $WQ_v$ . For  $Cp_v$  and  $Qp$ , the designer can compute curve numbers (CN) based on the actual measured impervious area at a site using:

$$CN = \frac{(98)I + \sum(CN)(P)}{A}$$

where:

- $CN$  = curve number for the appropriate pervious cover
- $I$  = impervious area at the site
- $P$  = pervious area at the site
- $A$  = total site area