

Eurocode 3: Design of steel structures —

Part 1-1: General rules and rules for buildings

The European Standard EN 1993-1-1:2005 has the status of a
British Standard

ICS 91.010.30; 91.080.10

National foreword

This British Standard is the official English language version of EN 1993-1-1:2005, including Corrigendum February 2006. It supersedes DD ENV 1993-1-1:1992, which is withdrawn.

The start and finish of text introduced or altered by corrigendum is indicated in the text by tags **AC** and **AC**. Tags indicating changes to CEN text carry the number of the CEN corrigendum. For example, text altered by June 2006 corrigendum is indicated by **AC1** and **AC1**.

The structural Eurocodes are divided into packages by grouping Eurocodes for each of the main materials, concrete, steel, composite concrete and steel, timber, masonry and aluminium, this is to enable a common date of withdrawal (DOW) for all the relevant parts that are needed for a particular design. The conflicting national standards will be withdrawn at the end of the coexistence period, after all the EN Eurocodes of a package are available.

Following publication of the EN, there is a period of allowed for the national calibration during which the national annex is issued, followed by a coexistence period of a maximum 3 years. During the coexistence period Member States are encouraged to adapt their national provisions. Conflicting national standards will be withdrawn by March 2010 at the latest.

BS EN 1993-1-1 will partially supersede BS 449-2, 5400-3 and 5950-1, which will be withdrawn by March 2010.

The UK participating in its preparation was entrusted by Technical Committee B/525, Building and civil engineering structures, to Subcommittee B/525/31, Structural use of steel, which has the responsibility to:

- aid enquirers to understand the text;
- present to the responsible international/European committee any enquiries on the interpretation, or proposals for change, and keep the UK interests informed;
- monitor related international and European developments and promulgate them in the UK.

A list of organizations represented on this subcommittee can be obtained on request to its secretary.

Where a normative part of this EN allows for a choice to be made at the national level, the range and possible choice will be given in the normative text, and a note will qualify it as a Nationally Determined Parameter (NDP). NDPs can be a specific value for a factor, a specific level or class, a particular method or a particular application rule if several are proposed in the EN.

To enable EN 1993-1-1 to be used in the UK, the NDPs will be published in a National Annex, which will be made available by BSI in due course, after public consultation has taken place.

This British Standard was published under the authority of the Standards Policy and Strategy Committee on 18 May 2005

© BSI 2006

Amendments issued since publication

Amd. No.	Date	Comments
16568 Corrigendum No. 1	29 September 2006	See national foreword and revision to supersession details

This publication does not purport to include all the necessary provisions of a contract. Users are responsible for its correct application.

Compliance with a British Standard does not of itself confer immunity from legal obligations.

EUROPEAN STANDARD
NORME EUROPÉENNE
EUROPÄISCHE NORM

EN 1993-1-1

May 2005

ICS 91.010.30; 91.080.10

Supersedes ENV 1993-1-1:1992
Incorporating Corrigendum February 2006

English version

Eurocode 3: Design of steel structures - Part 1-1: General rules and rules for buildings

Eurocode 3: Calcul des structures en acier - Partie 1-1:
Règles générales et règles pour les bâtiments

Eurocode 3: Bemessung und Konstruktion von Stahlbauten
- Teil 1-1: Allgemeine Bemessungsregeln und Regeln für
den Hochbau

This European Standard was approved by CEN on 16 April 2004.

CEN members are bound to comply with the CEN/CENELEC Internal Regulations which stipulate the conditions for giving this European Standard the status of a national standard without any alteration. Up-to-date lists and bibliographical references concerning such national standards may be obtained on application to the Central Secretariat or to any CEN member.

This European Standard exists in three official versions (English, French, German). A version in any other language made by translation under the responsibility of a CEN member into its own language and notified to the Central Secretariat has the same status as the official versions.

CEN members are the national standards bodies of Austria, Belgium, Cyprus, Czech Republic, Denmark, Estonia, Finland, France, Germany, Greece, Hungary, Iceland, Ireland, Italy, Latvia, Lithuania, Luxembourg, Malta, Netherlands, Norway, Poland, Portugal, Slovakia, Slovenia, Spain, Sweden, Switzerland and United Kingdom.



EUROPEAN COMMITTEE FOR STANDARDIZATION
COMITÉ EUROPÉEN DE NORMALISATION
EUROPÄISCHES KOMITEE FÜR NORMUNG

Management Centre: rue de Stassart, 36 B-1050 Brussels

Contents**Page**

1	General	9
1.1	<i>Scope.....</i>	9
1.2	<i>Normative references.....</i>	10
1.3	<i>Assumptions.....</i>	11
1.4	<i>Distinction between principles and application rules.....</i>	11
1.5	<i>Terms and definitions.....</i>	11
1.6	<i>Symbols.....</i>	12
1.7	<i>Conventions for member axes.....</i>	20
2	Basis of design.....	22
2.1	<i>Requirements.....</i>	22
2.1.1	Basic requirements.....	22
2.1.2	Reliability management.....	22
2.1.3	Design working life, durability and robustness.....	22
2.2	<i>Principles of limit state design.....</i>	23
2.3	<i>Basic variables.....</i>	23
2.3.1	Actions and environmental influences.....	23
2.3.2	Material and product properties.....	23
2.4	<i>Verification by the partial factor method.....</i>	23
2.4.1	Design values of material properties.....	23
2.4.2	Design values of geometrical data.....	23
2.4.3	Design resistances.....	24
2.4.4	Verification of static equilibrium (EQU).....	24
2.5	<i>Design assisted by testing.....</i>	24
3	Materials.....	25
3.1	<i>General.....</i>	25
3.2	<i>Structural steel.....</i>	25
3.2.1	Material properties.....	25
3.2.2	Ductility requirements.....	25
3.2.3	Fracture toughness.....	25
3.2.4	Through-thickness properties.....	27
3.2.5	Tolerances.....	28
3.2.6	Design values of material coefficients.....	28
3.3	<i>Connecting devices.....</i>	28
3.3.1	Fasteners.....	28
3.3.2	Welding consumables.....	28
3.4	<i>Other prefabricated products in buildings.....</i>	28
4	Durability.....	28
5	Structural analysis.....	29
5.1	<i>Structural modelling for analysis.....</i>	29
5.1.1	Structural modelling and basic assumptions.....	29

5.1.2	Joint modelling	29
5.1.3	Ground-structure interaction.....	29
5.2	<i>Global analysis</i>	30
5.2.1	Effects of deformed geometry of the structure	30
5.2.2	Structural stability of frames	31
5.3	<i>Imperfections</i>	32
5.3.1	Basis	32
5.3.2	Imperfections for global analysis of frames	33
5.3.3	Imperfection for analysis of bracing systems	36
5.3.4	Member imperfections.....	38
5.4	<i>Methods of analysis considering material non-linearities</i>	38
5.4.1	General	38
5.4.2	Elastic global analysis	39
5.4.3	Plastic global analysis.....	39
5.5	<i>Classification of cross sections</i>	40
5.5.1	Basis	40
5.5.2	Classification	40
5.6	<i>Cross-section requirements for plastic global analysis</i>	41
6	Ultimate limit states	45
6.1	<i>General</i>	45
6.2	<i>Resistance of cross-sections</i>	45
6.2.1	General	45
6.2.2	Section properties	46
6.2.3	Tension	49
6.2.4	Compression	49
6.2.5	Bending moment	50
6.2.6	Shear	50
6.2.7	Torsion.....	52
6.2.8	Bending and shear	53
6.2.9	Bending and axial force.....	54
6.2.10	Bending, shear and axial force	56
6.3	<i>Buckling resistance of members</i>	56
6.3.1	Uniform members in compression	56
6.3.2	Uniform members in bending.....	60
6.3.3	Uniform members in bending and axial compression	64
6.3.4	General method for lateral and lateral torsional buckling of structural components.....	65
6.3.5	Lateral torsional buckling of members with plastic hinges	67
6.4	<i>Uniform built-up compression members</i>	69
6.4.1	General	69
6.4.2	Laced compression members.....	71
6.4.3	Battened compression members	72
6.4.4	Closely spaced built-up members.....	74
7	Serviceability limit states	75
7.1	<i>General</i>	75
7.2	<i>Serviceability limit states for buildings</i>	75
7.2.1	Vertical deflections.....	75
7.2.2	Horizontal deflections.....	75
7.2.3	Dynamic effects.....	75
Annex A [informative]	– Method 1: Interaction factors k_{ij} for interaction formula in 6.3.3(4)	76

EN 1993-1-1: 2005 (E)

Annex B [informative] – Method 2: Interaction factors k_{ij} for interaction formula in 6.3.3(4) 79

Annex AB [informative] – Additional design provisions 81

Annex BB [informative] – Buckling of components of building structures 82

Foreword

This European Standard EN 1993, Eurocode 3: Design of steel structures, has been prepared by Technical Committee CEN/TC250 « Structural Eurocodes », the Secretariat of which is held by BSI. CEN/TC250 is responsible for all Structural Eurocodes.

This European Standard shall be given the status of a National Standard, either by publication of an identical text or by endorsement, at the latest by November 2005, and conflicting National Standards shall be withdrawn at latest by March 2010.

This Eurocode supersedes ENV 1993-1-1.

According to the CEN-CENELEC Internal Regulations, the National Standard Organizations of the following countries are bound to implement these European Standard: Austria, Belgium, Cyprus, Czech Republic, Denmark, Estonia, Finland, France, Germany, Greece, Hungary, Iceland, Ireland, Italy, Latvia, Lithuania, Luxembourg, Malta, Netherlands, Norway, Poland, Portugal, Slovakia, Slovenia, Spain, Sweden, Switzerland and United Kingdom.

Background of the Eurocode programme

In 1975, the Commission of the European Community decided on an action programme in the field of construction, based on article 95 of the Treaty. The objective of the programme was the elimination of technical obstacles to trade and the harmonization of technical specifications.

Within this action programme, the Commission took the initiative to establish a set of harmonized technical rules for the design of construction works which, in a first stage, would serve as an alternative to the national rules in force in the Member States and, ultimately, would replace them.

For fifteen years, the Commission, with the help of a Steering Committee with Representatives of Member States, conducted the development of the Eurocodes programme, which led to the first generation of European codes in the 1980s.

In 1989, the Commission and the Member States of the EU and EFTA decided, on the basis of an agreement¹ between the Commission and CEN, to transfer the preparation and the publication of the Eurocodes to the CEN through a series of Mandates, in order to provide them with a future status of European Standard (EN). This links *de facto* the Eurocodes with the provisions of all the Council's Directives and/or Commission's Decisions dealing with European standards (e.g. the Council Directive 89/106/EEC on construction products – CPD – and Council Directives 93/37/EEC, 92/50/EEC and 89/440/EEC on public works and services and equivalent EFTA Directives initiated in pursuit of setting up the internal market).

The Structural Eurocode programme comprises the following standards generally consisting of a number of Parts:

EN 1990	Eurocode:	Basis of structural design
EN 1991	Eurocode 1:	Actions on structures
EN 1992	Eurocode 2:	Design of concrete structures
EN 1993	Eurocode 3:	Design of steel structures
EN 1994	Eurocode 4:	Design of composite steel and concrete structures
EN 1995	Eurocode 5:	Design of timber structures
EN 1996	Eurocode 6:	Design of masonry structures
EN 1997	Eurocode 7:	Geotechnical design
EN 1998	Eurocode 8:	Design of structures for earthquake resistance

¹ Agreement between the Commission of the European Communities and the European Committee for Standardisation (CEN) concerning the work on EUROCODES for the design of building and civil engineering works (BC/CEN/03/89).

Eurocode standards recognize the responsibility of regulatory authorities in each Member State and have safeguarded their right to determine values related to regulatory safety matters at national level where these continue to vary from State to State.

Status and field of application of Eurocodes

The Member States of the EU and EFTA recognize that Eurocodes serve as reference documents for the following purposes :

- as a means to prove compliance of building and civil engineering works with the essential requirements of Council Directive 89/106/EEC, particularly Essential Requirement N°1 - Mechanical resistance and stability - and Essential Requirement N°2 - Safety in case of fire;
- as a basis for specifying contracts for construction works and related engineering services;
- as a framework for drawing up harmonized technical specifications for construction products (ENs and ETAs)

The Eurocodes, as far as they concern the construction works themselves, have a direct relationship with the Interpretative Documents² referred to in Article 12 of the CPD, although they are of a different nature from harmonized product standard³. Therefore, technical aspects arising from the Eurocodes work need to be adequately considered by CEN Technical Committees and/or EOTA Working Groups working on product standards with a view to achieving a full compatibility of these technical specifications with the Eurocodes.

The Eurocode standards provide common structural design rules for everyday use for the design of whole structures and component products of both a traditional and an innovative nature. Unusual forms of construction or design conditions are not specifically covered and additional expert consideration will be required by the designer in such cases.

National Standards implementing Eurocodes

The National Standards implementing Eurocodes will comprise the full text of the Eurocode (including any annexes), as published by CEN, which may be preceded by a National title page and National foreword, and may be followed by a National annex (informative).

The National Annex (informative) may only contain information on those parameters which are left open in the Eurocode for national choice, known as Nationally Determined Parameters, to be used for the design of buildings and civil engineering works to be constructed in the country concerned, i.e. :

- values for partial factors and/or classes where alternatives are given in the Eurocode,
- values to be used where a symbol only is given in the Eurocode,
- geographical and climatic data specific to the Member State, e.g. snow map,
- the procedure to be used where alternative procedures are given in the Eurocode,
- references to non-contradictory complementary information to assist the user to apply the Eurocode.

Links between Eurocodes and product harmonized technical specifications (ENs

² According to Art. 3.3 of the CPD, the essential requirements (ERs) shall be given concrete form in interpretative documents for the creation of the necessary links between the essential requirements and the mandates for hENs and ETAGs/ETAs.

³ According to Art. 12 of the CPD the interpretative documents shall :

- a) give concrete form to the essential requirements by harmonizing the terminology and the technical bases and indicating classes or levels for each requirement where necessary ;
- b) indicate methods of correlating these classes or levels of requirement with the technical specifications, e.g. methods of calculation and of proof, technical rules for project design, etc. ;
- c) serve as a reference for the establishment of harmonized standards and guidelines for European technical approvals.

The Eurocodes, *de facto*, play a similar role in the field of the ER 1 and a part of ER 2.

and ETAs)

There is a need for consistency between the harmonized technical specifications for construction products and the technical rules for works⁴. Furthermore, all the information accompanying the CE Marking of the construction products which refer to Eurocodes should clearly mention which Nationally Determined Parameters have been taken into account.

Additional information specific to EN 1993-1

EN 1993 is intended to be used with Eurocodes EN 1990 – Basis of Structural Design, EN 1991 – Actions on structures and EN 1992 to EN 1999, when steel structures or steel components are referred to.

EN 1993-1 is the first of six parts of EN 1993 – Design of Steel Structures. It gives generic design rules intended to be used with the other parts EN 1993-2 to EN 1993-6. It also gives supplementary rules applicable only to buildings.

EN 1993-1 comprises twelve subparts EN 1993-1-1 to EN 1993-1-12 each addressing specific steel components, limit states or materials.

It may also be used for design cases not covered by the Eurocodes (other structures, other actions, other materials) serving as a reference document for other CEN TC's concerning structural matters.

EN 1993-1 is intended for use by

- committees drafting design related product, testing and execution standards,
- clients (e.g. for the formulation of their specific requirements)
- designers and constructors
- relevant authorities

Numerical values for partial factors and other reliability parameters are recommended as basic values that provide an acceptable level of reliability. They have been selected assuming that an appropriate level of workmanship and quality management applies.

⁴ See Art.3.3 and Art.12 of the CPD, as well as clauses 4.2, 4.3.1, 4.3.2 and 5.2 of ID 1.

National annex for EN 1993-1-1

This standard gives values with notes indicating where national choices may have to be made. Therefore the National Standard implementing EN 1993-1 should have a National Annex containing all Nationally Determined Parameters to be used for the design of steel structures to be constructed in the relevant country.

National choice is allowed in EN 1993-1-1 through the following clauses:

- 2.3.1(1)
- 3.1(2)
- 3.2.1(1)
- 3.2.2(1)
- 3.2.3(1)
- 3.2.3(3)B
- 3.2.4(1)B
- 5.2.1(3)
- 5.2.2(8)
- 5.3.2(3)
- 5.3.2(11)
- 5.3.4(3)
- 6.1(1)
- 6.1(1)B
- 6.3.2.2(2)
- 6.3.2.3(1)
- 6.3.2.3(2)
- 6.3.2.4(1)B
- 6.3.2.4(2)B
- 6.3.3(5)
- 6.3.4(1)
- 7.2.1(1)B
- 7.2.2(1)B
- 7.2.3(1)B
- BB.1.3(3)B

1 General

1.1 Scope

1.1.1 Scope of Eurocode 3

(1) Eurocode 3 applies to the design of buildings and civil engineering works in steel. It complies with the principles and requirements for the safety and serviceability of structures, the basis of their design and verification that are given in EN 1990 – Basis of structural design.

(2) Eurocode 3 is concerned only with requirements for resistance, serviceability, durability and fire resistance of steel structures. Other requirements, e.g. concerning thermal or sound insulation, are not covered.

(3) Eurocode 3 is intended to be used in conjunction with:

- EN 1990 “Basis of structural design”
- EN 1991 “Actions on structures”
- ENs, ETAGs and ETAs for construction products relevant for steel structures
- EN 1090 “Execution of Steel Structures – Technical requirements”
- EN 1992 to EN 1999 when steel structures or steel components are referred to

(4) Eurocode 3 is subdivided in various parts:

EN 1993-1 Design of Steel Structures : General rules and rules for buildings.

EN 1993-2 Design of Steel Structures : Steel bridges.

EN 1993-3 Design of Steel Structures : Towers, masts and chimneys.

EN 1993-4 Design of Steel Structures : Silos, tanks and pipelines.

EN 1993-5 Design of Steel Structures : Piling.

EN 1993-6 Design of Steel Structures : Crane supporting structures.

(5) EN 1993-2 to EN 1993-6 refer to the generic rules in EN 1993-1. The rules in parts EN 1993-2 to EN 1993-6 supplement the generic rules in EN 1993-1.

(6) EN 1993-1 “General rules and rules for buildings” comprises:

EN 1993-1-1 Design of Steel Structures : General rules and rules for buildings.

EN 1993-1-2 Design of Steel Structures : Structural fire design.

EN 1993-1-3 Design of Steel Structures : Cold-formed thin gauge members and sheeting.

EN 1993-1-4 Design of Steel Structures : Stainless steels.

EN 1993-1-5 Design of Steel Structures : Plated structural elements.

EN 1993-1-6 Design of Steel Structures : Strength and stability of shell structures.

EN 1993-1-7 Design of Steel Structures : Strength and stability of planar plated structures transversely loaded.

EN 1993-1-8 Design of Steel Structures : Design of joints.

EN 1993-1-9 Design of Steel Structures : Fatigue strength of steel structures.

EN 1993-1-10 Design of Steel Structures : Selection of steel for fracture toughness and through-thickness properties.

EN 1993-1-11 Design of Steel Structures : Design of structures with tension components made of steel.

EN 1993-1-12 Design of Steel Structures : Supplementary rules for high strength steel.

1.1.2 Scope of Part 1.1 of Eurocode 3

(1) EN 1993-1-1 gives basic design rules for steel structures with material thicknesses $t \geq 3$ mm. It also gives supplementary provisions for the structural design of steel buildings. These supplementary provisions are indicated by the letter “B” after the paragraph number, thus ()B.

NOTE For cold formed thin gauge members and plate thicknesses $t < 3$ mm see EN 1993-1-3.

(2) The following subjects are dealt with in EN 1993-1-1:

Section 1: General

Section 2: Basis of design

Section 3: Materials

Section 4: Durability

Section 5: Structural analysis

Section 6: Ultimate limit states

Section 7: Serviceability limit states

(3) Sections 1 to 2 provide additional clauses to those given in EN 1990 “Basis of structural design”.

(4) Section 3 deals with material properties of products made of low alloy structural steels.

(5) Section 4 gives general rules for durability.

(6) Section 5 refers to the structural analysis of structures, in which the members can be modelled with sufficient accuracy as line elements for global analysis.

(7) Section 6 gives detailed rules for the design of cross sections and members.

(8) Section 7 gives rules for serviceability.

1.2 Normative references

This European Standard incorporates by dated or undated reference, provisions from other publications. These normative references are cited at the appropriate places in the text and the publications are listed hereafter. For dated references, subsequent amendments to or revisions of any of these publications apply to this European Standard only when incorporated in it by amendment or revision. For undated references the latest edition of the publication referred to applies (including amendments).

1.2.1 General reference standards

EN 1090 Execution of steel structures – Technical requirements

EN ISO 12944 Paints and varnishes – Corrosion protection of steel structures by protective paint systems

EN 1461 Hot dip galvanized coatings on fabricated iron and steel articles – specifications and test methods

1.2.2 Weldable structural steel reference standards

EN 10025-1:2004 Hot-rolled products of structural steels - Part 1: General delivery conditions.

EN 10025-2:2004 Hot-rolled products of structural steels - Part 2: Technical delivery conditions for non-alloy structural steels.

EN 10025-3:2004 Hot-rolled products of structural steels - Part 3: Technical delivery conditions for normalized / normalized rolled weldable fine grain structural steels.

EN 10025-4:2004	Hot-rolled products of structural steels - Part 4: Technical delivery conditions for thermomechanical rolled weldable fine grain structural steels.
EN 10025-5:2004	Hot-rolled products of structural steels - Part 5: Technical delivery conditions for structural steels with improved atmospheric corrosion resistance.
EN 10025-6:2004	Hot-rolled products of structural steels - Part 6: Technical delivery conditions for flat products of high yield strength structural steels in the quenched and tempered condition.
EN 10164:1993	Steel products with improved deformation properties perpendicular to the surface of the product - Technical delivery conditions.
EN 10210-1:1994	Hot finished structural hollow sections of non-alloy and fine grain structural steels – Part 1: Technical delivery requirements.
EN 10219-1:1997	Cold formed hollow sections of structural steel - Part 1: Technical delivery requirements.

1.3 Assumptions

- (1) In addition to the general assumptions of EN 1990 the following assumptions apply:
- fabrication and erection complies with EN 1090

1.4 Distinction between principles and application rules

- (1) The rules in EN 1990 clause 1.4 apply.

1.5 Terms and definitions

- (1) The rules in EN 1990 clause 1.5 apply.
- (2) The following terms and definitions are used in EN 1993-1-1 with the following meanings:

1.5.1

frame

the whole or a portion of a structure, comprising an assembly of directly connected structural elements, designed to act together to resist load; this term refers to both moment-resisting frames and triangulated frames; it covers both plane frames and three-dimensional frames

1.5.2

sub-frame

a frame that forms part of a larger frame, but is to be treated as an isolated frame in a structural analysis

1.5.3

type of framing

terms used to distinguish between frames that are either:

- **semi-continuous**, in which the structural properties of the members and joints need explicit consideration in the global analysis
- **continuous**, in which only the structural properties of the members need be considered in the global analysis
- **simple**, in which the joints are not required to resist moments

1.5.4

global analysis

the determination of a consistent set of internal forces and moments in a structure, which are in equilibrium with a particular set of actions on the structure

1.5.5

system length

distance in a given plane between two adjacent points at which a member is braced against lateral displacement in this plane, or between one such point and the end of the member

1.5.6

buckling length

system length of an otherwise similar member with pinned ends, which has the same buckling resistance as a given member or segment of member

1.5.7

shear lag effect

non-uniform stress distribution in wide flanges due to shear deformation; it is taken into account by using a reduced “effective” flange width in safety assessments

1.5.8

capacity design

design method for achieving the plastic deformation capacity of a member by providing additional strength in its connections and in other parts connected to it

1.5.9

uniform member

member with a constant cross-section along its whole length

1.6 Symbols

- (1) For the purpose of this standard the following symbols apply.
- (2) Additional symbols are defined where they first occur.

NOTE Symbols are ordered by appearance in EN 1993-1-1. Symbols may have various meanings.

Section 1

x-x	axis along a member
y-y	axis of a cross-section
z-z	axis of a cross-section
u-u	major principal axis (where this does not coincide with the y-y axis)
v-v	minor principal axis (where this does not coincide with the z-z axis)
b	width of a cross section
h	depth of a cross section
d	depth of straight portion of a web
t_w	web thickness
t_f	flange thickness
r	radius of root fillet
r_1	radius of root fillet
r_2	toe radius
t	thickness

Section 2

P_k	nominal value of the effect of prestressing imposed during erection
G_k	nominal value of the effect of permanent actions

X_K	characteristic values of material property
X_n	nominal values of material property
R_d	design value of resistance
R_k	characteristic value of resistance
γ_M	general partial factor
γ_{Mi}	particular partial factor
γ_{Mf}	partial factor for fatigue
η	conversion factor
a_d	design value of geometrical data

Section 3

f_y	yield strength
f_u	ultimate strength
R_{ch}	yield strength to product standards
R_m	ultimate strength to product standards
A_0	original cross-section area
ε_y	yield strain
ε_u	ultimate strain
Z_{Ed}	required design Z-value resulting from the magnitude of strains from restrained metal shrinkage under the weld beads.
Z_{Rd}	available design Z-value
E	modulus of elasticity
G	shear modulus
ν	Poisson's ratio in elastic stage
α	coefficient of linear thermal expansion

Section 5

α_{cr}	factor by which the design loads would have to be increased to cause elastic instability in a global mode
F_{Ed}	design loading on the structure
F_{cr}	elastic critical buckling load for global instability mode based on initial elastic stiffnesses
H_{Ed}	design value of the horizontal reaction at the bottom of the storey to the horizontal loads and fictitious horizontal loads
V_{Ed}	total design vertical load on the structure on the bottom of the storey
$\delta_{H,Ed}$	horizontal displacement at the top of the storey, relative to the bottom of the storey
h	storey height
$\bar{\lambda}$	non dimensional slenderness
N_{Ed}	design value of the axial force
ϕ	global initial sway imperfection
ϕ_0	basic value for global initial sway imperfection
α_h	reduction factor for height h applicable to columns
h	height of the structure

EN 1993-1-1: 2005 (E)

α_m	reduction factor for the number of columns in a row
m	number of columns in a row
e_0	maximum amplitude of a member imperfection
L	member length
η_{init}	amplitude of elastic critical buckling mode
η_{cr}	shape of elastic critical buckling mode
$e_{0,d}$	design value of maximum amplitude of an imperfection
M_{Rk}	characteristic moment resistance of the critical cross section
N_{Rk}	characteristic resistance to normal force of the critical cross section
α	imperfection factor
$EI \eta_{cr}''$	bending moment due to η_{cr} at the critical cross section
χ	reduction factor for the relevant buckling curve
$\alpha_{ult,k}$	minimum force amplifier to reach the characteristic resistance without taking buckling into account
α_{cr}	minimum force amplifier to reach the elastic critical buckling
q	equivalent force per unit length
δ_q	in-plane deflection of a bracing system
q_d	equivalent design force per unit length
M_{Ed}	design bending moment
k	factor for $e_{0,d}$
ε	strain
σ	stress
$\sigma_{com,Ed}$	maximum design compressive stress in an element
ℓ	length
ε	coefficient depending on f_y
c	width or depth of a part of a cross section
α	portion of a part of a cross section in compression
ψ	stress or strain ratio
k_σ	plate buckling coefficient
d	outer diameter of circular tubular sections

Section 6

γ_{M0}	partial factor for resistance of cross-sections whatever the class is
γ_{M1}	partial factor for resistance of members to instability assessed by member checks
γ_{M2}	partial factor for resistance of cross-sections in tension to fracture
$\sigma_{x,Ed}$	design value of the local longitudinal stress
$\sigma_{z,Ed}$	design value of the local transverse stress
τ_{Ed}	design value of the local shear stress
N_{Ed}	design normal force
$M_{y,Ed}$	design bending moment, y-y axis
$M_{z,Ed}$	design bending moment, z-z axis
N_{Rd}	design values of the resistance to normal forces

$M_{y,Rd}$	design values of the resistance to bending moments, y-y axis
$M_{z,Rd}$	design values of the resistance to bending moments, z-z axis
s	staggered pitch, the spacing of the centres of two consecutive holes in the chain measured parallel to the member axis
p	spacing of the centres of the same two holes measured perpendicular to the member axis
n	number of holes extending in any diagonal or zig-zag line progressively across the member or part of the member
d_0	diameter of hole
e_N	shift of the centroid of the effective area A_{eff} relative to the centre of gravity of the gross cross section
ΔM_{Ed}	additional moment from shift of the centroid of the effective area A_{eff} relative to the centre of gravity of the gross cross section
A_{eff}	effective area of a cross section
$N_{t,Rd}$	design values of the resistance to tension forces
$N_{pl,Rd}$	design plastic resistance to normal forces of the gross cross-section
$N_{u,Rd}$	design ultimate resistance to normal forces of the net cross-section at holes for fasteners
A_{net}	net area of a cross section
$N_{net,Rd}$	design plastic resistance to normal forces of the net cross-section
$N_{c,Rd}$	design resistance to normal forces of the cross-section for uniform compression
$M_{c,Rd}$	design resistance for bending about one principal axis of a cross-section
W_{pl}	plastic section modulus
$W_{el,min}$	minimum elastic section modulus
$W_{eff,min}$	minimum effective section modulus
A_f	area of the tension flange
$A_{f,net}$	net area of the tension flange
V_{Ed}	design shear force
$V_{c,Rd}$	design shear resistance
$V_{pl,Rd}$	plastic design shear resistance
A_v	shear area
η	factor for shear area
S	first moment of area
I	second moment of area
A_w	area of a web
A_f	area of one flange
T_{Ed}	design value of total torsional moments
T_{Rd}	design resistance to torsional moments
$T_{t,Ed}$	design value of internal St. Venant torsion
$T_{w,Ed}$	design value of internal warping torsion
$\tau_{t,Ed}$	design shear stresses due to St. Venant torsion
$\tau_{w,Ed}$	design shear stresses due to warping torsion
$\sigma_{w,Ed}$	design direct stresses due to the bimoment B_{Ed}
B_{Ed}	bimoment
$V_{pl,T,Rd}$	reduced design plastic shear resistance making allowance for the presence of a torsional moment

EN 1993-1-1: 2005 (E)

- ρ reduction factor to determine reduced design values of the resistance to bending moments making allowance for the presence of shear forces
- $M_{V,Rd}$ reduced design values of the resistance to bending moments making allowance for the presence of shear forces
- $M_{N,Rd}$ reduced design values of the resistance to bending moments making allowance for the presence of normal forces
- n ratio of design normal force to design plastic resistance to normal forces of the gross cross-section
- a ratio of web area to gross area
- α parameter introducing the effect of biaxial bending
- β parameter introducing the effect of biaxial bending
- $e_{N,y}$ shift of the centroid of the effective area A_{eff} relative to the centre of gravity of the gross cross section (y-y axis)
- $e_{N,z}$ shift of the centroid of the effective area A_{eff} relative to the centre of gravity of the gross cross section (z-z axis)
- $W_{eff,min}$ minimum effective section modulus
- $N_{b,Rd}$ design buckling resistance of a compression member
- χ reduction factor for relevant buckling mode
- Φ value to determine the reduction factor χ
- a_0, a, b, c, d class indexes for buckling curves
- N_{cr} elastic critical force for the relevant buckling mode based on the gross cross sectional properties
- i radius of gyration about the relevant axis, determined using the properties of the gross cross-section
- λ_1 slenderness value to determine the relative slenderness
- $\bar{\lambda}_T$ relative slenderness for torsional or torsional-flexural buckling
- $N_{cr,TF}$ elastic torsional-flexural buckling force
- $N_{cr,T}$ elastic torsional buckling force
- $M_{b,Rd}$ design buckling resistance moment
- χ_{LT} reduction factor for lateral-torsional buckling
- Φ_{LT} value to determine the reduction factor χ_{LT}
- α_{LT} imperfection factor
- $\bar{\lambda}_{LT}$ non dimensional slenderness for lateral torsional buckling
- M_{cr} elastic critical moment for lateral-torsional buckling
- $\bar{\lambda}_{LT,0}$ plateau length of the lateral torsional buckling curves for rolled sections
- β correction factor for the lateral torsional buckling curves for rolled sections
- $\chi_{LT,mod}$ modified reduction factor for lateral-torsional buckling
- f modification factor for χ_{LT}
- k_c correction factor for moment distribution
- ψ ratio of moments in segment
- L_c length between lateral restraints
- $\bar{\lambda}_f$ equivalent compression flange slenderness
- i_{fz} radius of gyration of compression flange about the minor axis of the section
- $I_{eff,f}$ effective second moment of area of compression flange about the minor axis of the section

$A_{\text{eff},f}$	effective area of compression flange
$A_{\text{eff},w,c}$	effective area of compressed part of web
$\bar{\lambda}_{c0}$	slenderness parameter
$k_{f\ell}$	modification factor
ΔM_y	moments due to the shift of the centroidal y-y axis
ΔM_z	moments due to the shift of the centroidal z-z axis
χ_y	reduction factor due to flexural buckling (y-y axis)
χ_z	reduction factor due to flexural buckling (z-z axis)
k_{yy}	interaction factor
k_{yz}	interaction factor
k_{zy}	interaction factor
k_{zz}	interaction factor
$\bar{\lambda}_{\text{op}}$	global non dimensional slenderness of a structural component for out-of-plane buckling
χ_{op}	reduction factor for the non-dimensional slenderness $\bar{\lambda}_{\text{op}}$
$\alpha_{\text{ult},k}$	minimum load amplifier of the design loads to reach the characteristic resistance of the most critical cross section
$\alpha_{\text{cr},\text{op}}$	minimum amplifier for the in plane design loads to reach the elastic critical resistance with regard to lateral or lateral torsional buckling
N_{Rk}	characteristic value of resistance to compression
$M_{y,\text{Rk}}$	characteristic value of resistance to bending moments about y-y axis
$M_{z,\text{Rk}}$	characteristic value of resistance to bending moments about z-z axis
Q_m	local force applied at each stabilized member at the plastic hinge locations
L_{stable}	stable length of segment
L_{ch}	buckling length of chord
h_0	distance of centrelines of chords of a built-up column
a	distance between restraints of chords
α	angle between axes of chord and lacings
i_{min}	minimum radius of gyration of single angles
A_{ch}	area of one chord of a built-up column
$N_{\text{ch},\text{Ed}}$	design chord force in the middle of a built-up member
M_{Ed}^I	design value of the maximum moment in the middle of the built-up member
I_{eff}	effective second moment of area of the built-up member
S_v	shear stiffness of built-up member from the lacings or battened panel
n	number of planes of lacings
A_d	area of one diagonal of a built-up column
d	length of a diagonal of a built-up column
A_v	area of one post (or transverse element) of a built-up column
I_{ch}	in plane second moment of area of a chord
I_b	in plane second moment of area of a batten
μ	efficiency factor

EN 1993-1-1: 2005 (E)

i_y radius of gyration (y-y axis)

Annex A

C_{my} equivalent uniform moment factor
 C_{mz} equivalent uniform moment factor
 C_{mLT} equivalent uniform moment factor
 μ_y factor
 μ_z factor
 $N_{cr,y}$ elastic flexural buckling force about the y-y axis
 $N_{cr,z}$ elastic flexural buckling force about the z-z axis
 C_{yy} factor
 C_{yz} factor
 C_{zy} factor
 C_{zz} factor
 w_y factor
 w_z factor
 n_{pl} factor
 $\bar{\lambda}_{max}$ maximum of $\bar{\lambda}_y$ and $\bar{\lambda}_z$
 b_{LT} factor
 c_{LT} factor
 d_{LT} factor
 e_{LT} factor
 ψ_y ratio of end moments (y-y axis)
 $C_{my,0}$ factor
 $C_{mz,0}$ factor
 a_{LT} factor
 I_T St. Venant torsional constant
 I_y second moment of area about y-y axis
 $M_{i,Ed}(x)$ maximum first order moment
 $|\delta_x|$ maximum member displacement along the member

Annex B

α_s factor
 α_h factor
 C_m equivalent uniform moment factor

Annex AB

γ_G partial factor for permanent loads
 G_k characteristic value of permanent loads
 γ_Q partial factor for variable loads
 Q_k characteristic value of variable loads

Annex BB

$\bar{\lambda}_{\text{eff},v}$	effective slenderness ratio for buckling about v-v axis
$\bar{\lambda}_{\text{eff},y}$	effective slenderness ratio for buckling about y-y axis
$\bar{\lambda}_{\text{eff},z}$	effective slenderness ratio for buckling about z-z axis
L	system length
L_{cr}	buckling length
S	shear stiffness provided by sheeting
I_w	warping constant
$C_{\theta,k}$	rotational stiffness provided by stabilizing continuum and connections
K_{θ}	factor for considering the type of analysis
K_{θ}	factor for considering the moment distribution and the type of restraint
$C_{\theta R,k}$	rotational stiffness provided by the stabilizing continuum to the beam assuming a stiff connection to the member
$C_{\theta C,k}$	rotational stiffness of the connection between the beam and the stabilizing continuum
$C_{\theta D,k}$	rotational stiffness deduced from an analysis of the distortional deformations of the beam cross sections
L_m	stable length between adjacent lateral restraints
L_k	stable length between adjacent torsional restraints
L_s	stable length between a plastic hinge location and an adjacent torsional restraint
C_1	modification factor for moment distribution
C_m	modification factor for linear moment gradient
C_n	modification factor for non-linear moment gradient
a	distance between the centroid of the member with the plastic hinge and the centroid of the restraint members
B_0	factor
B_1	factor
B_2	factor
η	ratio of critical values of axial forces
i_s	radius of gyration related to centroid of restraining member
β_t	ratio of the algebraically smaller end moment to the larger end moment
R_1	moment at a specific location of a member
R_2	moment at a specific location of a member
R_3	moment at a specific location of a member
R_4	moment at a specific location of a member
R_5	moment at a specific location of a member
R_E	maximum of R_1 or R_5
R_s	maximum value of bending moment anywhere in the length L_y
c	taper factor
h_h	additional depth of the haunch or taper
h_{max}	maximum depth of cross-section within the length L_y
h_{min}	minimum depth of cross-section within the length L_y

h_s vertical depth of the un-haunched section

L_h length of haunch within the length L_y

L_y length between restraints

1.7 Conventions for member axes

(1) The convention for member axes is:

x-x - along the member

y-y - axis of the cross-section

z-z - axis of the cross-section

(2) For steel members, the conventions used for cross-section axes are:

- generally:

y-y - cross-section axis parallel to the flanges

z-z - cross-section axis perpendicular to the flanges

- for angle sections:

y-y - axis parallel to the smaller leg

z-z - axis perpendicular to the smaller leg

- where necessary:

u-u - major principal axis (where this does not coincide with the yy axis)

v-v - minor principal axis (where this does not coincide with the zz axis)

(3) The symbols used for dimensions and axes of rolled steel sections are indicated in Figure 1.1.

(4) The convention used for subscripts that indicate axes for moments is: "Use the axis about which the moment acts."

NOTE All rules in this Eurocode relate to principal axis properties, which are generally defined by the axes y-y and z-z but for sections such as angles are defined by the axes u-u and v-v.

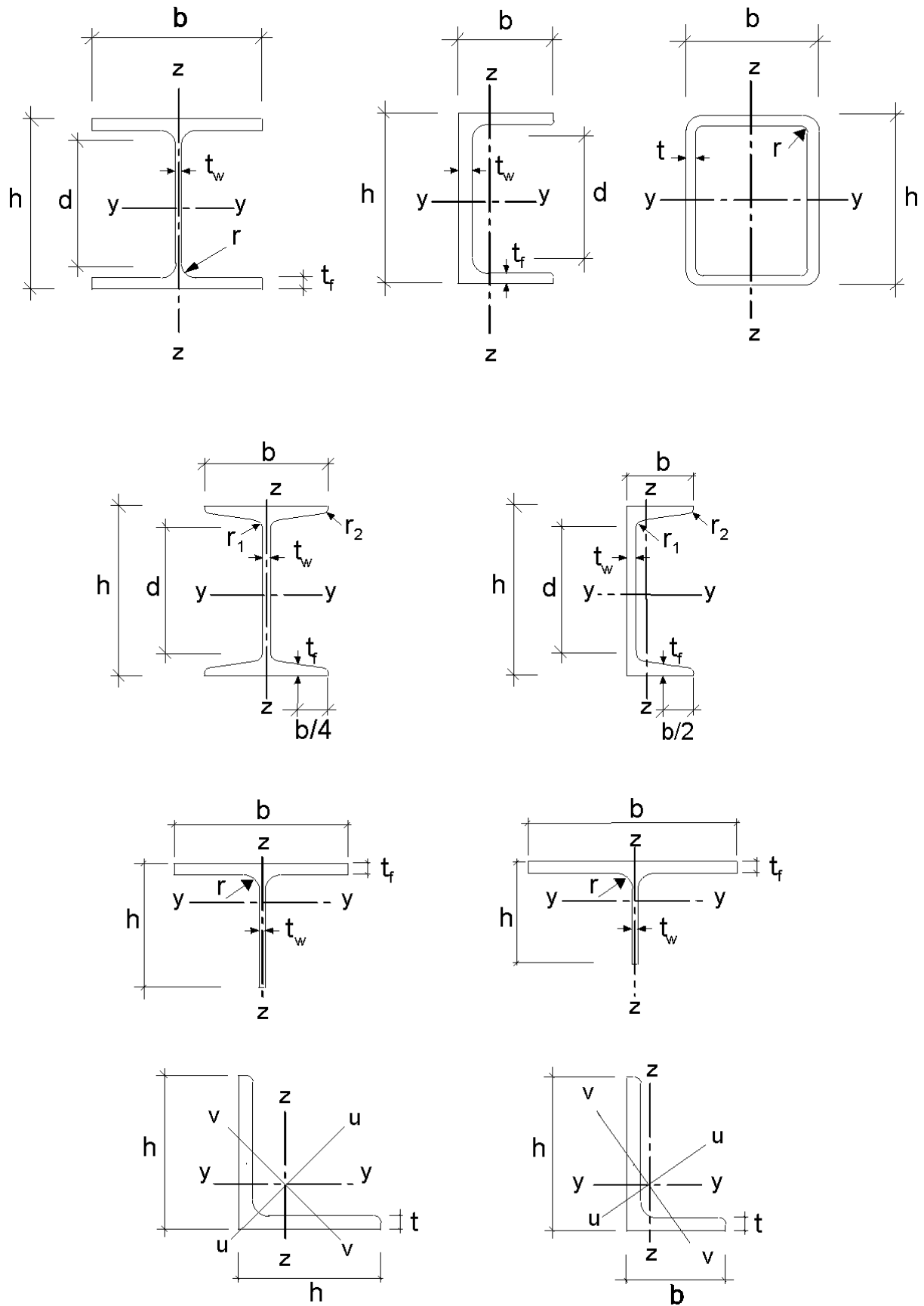

Figure 1.1: Dimensions and axes of sections

2 Basis of design

2.1 Requirements

2.1.1 Basic requirements

- AC1 (1)P The design of steel structures shall be in accordance with the general rules given in EN 1990. AC1
- (2) The supplementary provisions for steel structures given in this section should also be applied.
- (3) The basic requirements of EN 1990 section 2 should be deemed to be satisfied where limit state design is used in conjunction with the partial factor method and the load combinations given in EN 1990 together with the actions given in EN 1991.
- (4) The rules for resistances, serviceability and durability given in the various parts of EN 1993 should be applied.

2.1.2 Reliability management

- (1) Where different levels of reliability are required, these levels should preferably be achieved by an appropriate choice of quality management in design and execution, according to EN 1990 Annex C and EN 1090.

2.1.3 Design working life, durability and robustness

2.1.3.1 General

- AC1 (1)P Depending upon the type of action affecting durability and the design working life (see EN 1990) steel structures shall be AC1
- designed against corrosion by means of
 - suitable surface protection (see EN ISO 12944)
 - the use of weathering steel
 - the use of stainless steel (see EN 1993-1-4)
 - detailed for sufficient fatigue life (see EN 1993-1-9)
 - designed for wearing
 - designed for accidental actions (see EN 1991-1-7)
 - inspected and maintained.

2.1.3.2 Design working life for buildings

- AC1 (1)P,B The design working life shall be taken as the period for which a building structure is expected to be used for its intended purpose. AC1
- (2)B For the specification of the intended design working life of a permanent building see Table 2.1 of EN 1990.
- (3)B For structural elements that cannot be designed for the total design life of the building, see 2.1.3.3(3)B.

2.1.3.3 Durability for buildings

- AC1 (1)P,B To ensure durability, buildings and their components shall either be designed for environmental actions and fatigue if relevant or else protected from them. AC1

AC1 (2)P,B The effects of deterioration of material, corrosion or fatigue where relevant shall be taken into account by appropriate choice of material, see EN 1993-1-4 and EN 1993-1-10, and details, see EN 1993-1-9, or by structural redundancy and by the choice of an appropriate corrosion protection system. **AC1**

(3)B If a building includes components that need to be replaceable (e.g. bearings in zones of soil settlement), the possibility of their safe replacement should be verified as a transient design situation.

2.2 Principles of limit state design

(1) The resistance of cross-sections and members specified in this Eurocode 3 for the ultimate limit states as defined in EN 1990, 3.3 are based on tests in which the material exhibited sufficient ductility to apply simplified design models.

(2) The resistances specified in this Eurocode Part may therefore be used where the conditions for materials in section 3 are met.

2.3 Basic variables

2.3.1 Actions and environmental influences

(1) Actions for the design of steel structures should be taken from EN 1991. For the combination of actions and partial factors of actions see Annex A to EN 1990.

NOTE 1 The National Annex may define actions for particular regional or climatic or accidental situations.

NOTE 2B For proportional loading for incremental approach, see Annex AB.1.

NOTE 3B For simplified load arrangement, see Annex AB.2.

(2) The actions to be considered in the erection stage should be obtained from EN 1991-1-6.

(3) Where the effects of predicted absolute and differential settlements need to be considered, best estimates of imposed deformations should be used.

(4) The effects of uneven settlements or imposed deformations or other forms of prestressing imposed during erection should be taken into account by their nominal value P_k as permanent actions and grouped with other permanent actions G_k from a single action ($G_k + P_k$).

(5) Fatigue actions not defined in EN 1991 should be determined according to Annex A of EN 1993-1-9.

2.3.2 Material and product properties

(1) Material properties for steels and other construction products and the geometrical data to be used for design should be those specified in the relevant ENs, ETAGs or ETAs unless otherwise indicated in this standard.

2.4 Verification by the partial factor method

2.4.1 Design values of material properties

AC1 (1)P For the design of steel structures characteristic values X_k or nominal values X_n of material properties shall be used as indicated in this Eurocode. **AC1**

2.4.2 Design values of geometrical data

(1) Geometrical data for cross-sections and systems may be taken from product standards hEN or drawings for the execution to EN 1090 and treated as nominal values.

(2) Design values of geometrical imperfections specified in this standard are equivalent geometric imperfections that take into account the effects of:

- geometrical imperfections of members as governed by geometrical tolerances in product standards or the execution standard;
- structural imperfections due to fabrication and erection;
- residual stresses;
- variation of the yield strength.

2.4.3 Design resistances

(1) For steel structures equation (6.6c) or equation (6.6d) of EN 1990 applies:

$$R_d = \frac{R_k}{\gamma_M} = \frac{1}{\gamma_M} R_k (\eta_1 X_{k1}; \eta_i X_{ki}; a_d) \quad (2.1)$$

where R_k is the characteristic value of the particular resistance determined with characteristic or nominal values for the material properties and dimensions

γ_M is the global partial factor for the particular resistance

NOTE For the definitions of η_1 , η_i , X_{k1} , X_{ki} and a_d see EN 1990.

2.4.4 Verification of static equilibrium (EQU)

(1) The reliability format for the verification of static equilibrium in Table 1.2 (A) in Annex A of EN 1990 also applies to design situations equivalent to (EQU), e.g. for the design of holding down anchors or the verification of uplift of bearings of continuous beams.

2.5 Design assisted by testing

(1) The resistances R_k in this standard have been determined using Annex D of EN 1990.

(2) In recommending classes of constant partial factors γ_{Mi} the characteristic values R_k were obtained from

$$R_k = R_d \gamma_{Mi} \quad (2.2)$$

where R_d are design values according to Annex D of EN 1990

γ_{Mi} are recommended partial factors.

NOTE 1 The numerical values of the recommended partial factors γ_{Mi} have been determined such that R_k represents approximately the 5 %-fractile for an infinite number of tests.

NOTE 2 For characteristic values of fatigue strength and partial factors γ_{Mf} for fatigue see EN 1993-1-9.

NOTE 3 For characteristic values of toughness resistance and safety elements for the toughness verification see EN 1993-1-10.

(3) Where resistances R_k for prefabricated products should be determined from tests, the procedure in (2) should be followed.

3 Materials

3.1 General

- (1) The nominal values of material properties given in this section should be adopted as characteristic values in design calculations.
- (2) This Part of EN 1993 covers the design of steel structures fabricated from steel material conforming to the steel grades listed in Table 3.1.

NOTE For other steel material and products see National Annex.

3.2 Structural steel

3.2.1 Material properties

- (1) The nominal values of the yield strength f_y and the ultimate strength f_u for structural steel should be obtained
- a) either by adopting the values $f_y = R_{ch}$ and $f_u = R_m$ direct from the product standard
- b) or by using the simplification given in Table 3.1

NOTE The National Annex may give the choice.

3.2.2 Ductility requirements

- (1) For steels a minimum ductility is required that should be expressed in terms of limits for:
- the ratio f_u / f_y of the specified minimum ultimate tensile strength f_u to the specified minimum yield strength f_y ;
 - the elongation at failure on a gauge length of $5,65 \sqrt{A_0}$ (where A_0 is the original cross-sectional area);
 - the ultimate strain ε_u , where ε_u corresponds to the ultimate strength f_u .

NOTE The limiting values of the ratio f_u / f_y , the elongation at failure and the ultimate strain ε_u may be defined in the National Annex. The following values are recommended:

- $f_u / f_y \geq 1,10$;
- elongation at failure not less than 15%;
- $\varepsilon_u \geq 15\varepsilon_y$, where ε_y is the yield strain ($\varepsilon_y = f_y / E$).

- (2) Steel conforming with one of the steel grades listed in Table 3.1 should be accepted as satisfying these requirements.

3.2.3 Fracture toughness

- AC1** (1)P The material shall have sufficient fracture toughness to avoid brittle fracture of tension elements at the lowest service temperature expected to occur within the intended design life of the structure. **AC1**

NOTE The lowest service temperature to be adopted in design may be given in the National Annex.

- (2) No further check against brittle fracture need to be made if the conditions given in EN 1993-1-10 are satisfied for the lowest temperature.

(3)B For building components under compression a minimum toughness property should be selected.

NOTE B The National Annex may give information on the selection of toughness properties for members in compression. The use of Table 2.1 of EN 1993-1-10 for $\sigma_{Ed} = 0,25 f_y(t)$ is recommended.

(4) For selecting steels for members with hot dip galvanized coatings see EN 1461.

Table 3.1: Nominal values of yield strength f_y and ultimate tensile strength f_u for hot rolled structural steel

Standard and steel grade	Nominal thickness of the element t [mm]			
	t ≤ 40 mm		40 mm < t ≤ 80 mm	
	f_y [N/mm ²]	f_u [N/mm ²]	f_y [N/mm ²]	f_u [N/mm ²]
EN 10025-2				
S 235	235	360	215	360
S 275	275	430	255	410
S 355	355	510	335	470
S 450	440	550	410	550
EN 10025-3				
S 275 N/NL	275	390	255	370
S 355 N/NL	355	490	335	470
S 420 N/NL	420	520	390	520
S 460 N/NL	460	540	430	540
EN 10025-4				
S 275 M/ML	275	370	255	360
S 355 M/ML	355	470	335	450
S 420 M/ML	420	520	390	500
S 460 M/ML	460	540	430	530
EN 10025-5				
S 235 W	235	360	215	340
S 355 W	355	510	335	490
EN 10025-6				
S 460 Q/QL/QL1	460	570	440	550

Table 3.1 (continued): Nominal values of yield strength f_y and ultimate tensile strength f_u for structural hollow sections

Standard and steel grade	Nominal thickness of the element t [mm]			
	$t \leq 40$ mm		$40 \text{ mm} < t \leq 80$ mm	
	f_y [N/mm ²]	f_u [N/mm ²]	f_y [N/mm ²]	f_u [N/mm ²]
EN 10210-1				
S 235 H	235	360	215	340
S 275 H	275	430	255	410
S 355 H	355	510	335	490
S 275 NH/NLH	275	390	255	370
S 355 NH/NLH	355	490	335	470
S 420 NH/NHL	420	540	390	520
S 460 NH/NLH	460	560	430	550
EN 10219-1				
S 235 H	235	360		
S 275 H	275	430		
S 355 H	355	510		
S 275 NH/NLH	275	370		
S 355 NH/NLH	355	470		
S 460 NH/NLH	460	550		
S 275 MH/MLH	275	360		
S 355 MH/MLH	355	470		
S 420 MH/MLH	420	500		
S 460 MH/MLH	460	530		

3.2.4 Through-thickness properties

(1) Where steel with improved through-thickness properties is necessary according to EN 1993-1-10, steel according to the required quality class in EN 10164 should be used.

NOTE 1 Guidance on the choice of through-thickness properties is given in EN 1993-1-10.

NOTE 2B Particular care should be given to welded beam to column connections and welded end plates with tension in the through-thickness direction.

NOTE 3B The National Annex may give the relevant allocation of target values Z_{Ed} according to 3.2(2) of EN 1993-1-10 to the quality class in EN 10164. The allocation in Table 3.2 is recommended for buildings:

Table 3.2: Choice of quality class according to EN 10164

Target value of Z_{Ed} according to EN 1993-1-10	Required value of Z_{Rd} expressed in terms of design Z -values according to EN 10164
$Z_{Ed} \leq 10$	—
$10 < Z_{Ed} \leq 20$	Z 15
$20 < Z_{Ed} \leq 30$	Z 25
$Z_{Ed} > 30$	Z 35

3.2.5 Tolerances

- (1) The dimensional and mass tolerances of rolled steel sections, structural hollow sections and plates should conform with the relevant product standard, ETAG or ETA unless more severe tolerances are specified.
- (2) For welded components the tolerances given in EN 1090 should be applied.
- (3) For structural analysis and design the nominal values of dimensions should be used.

3.2.6 Design values of material coefficients

(1) The material coefficients to be adopted in calculations for the structural steels covered by this Eurocode Part should be taken as follows:

- modulus of elasticity $E = 210\,000 \text{ N/mm}^2$
- shear modulus $G = \frac{E}{2(1+\nu)} \approx 81\,000 \text{ N/mm}^2$
- Poisson's ratio in elastic stage $\nu = 0,3$
- coefficient of linear thermal expansion $\alpha = 12 \times 10^{-6} \text{ per K}$ (for $T \leq 100 \text{ }^\circ\text{C}$)

NOTE For calculating the structural effects of unequal temperatures in composite concrete-steel structures to EN 1994 the coefficient of linear thermal expansion is taken as $\alpha = 10 \times 10^{-6} \text{ per K}$.

3.3 Connecting devices

3.3.1 Fasteners

- (1) Requirements for fasteners are given in EN 1993-1-8.

3.3.2 Welding consumables

- (1) Requirements for welding consumables are given in EN 1993-1-8.

3.4 Other prefabricated products in buildings

(1)B Any semi-finished or finished structural product used in the structural design of buildings should comply with the relevant EN Product Standard or ETAG or ETA.

4 Durability

- (1) The basic requirements for durability are set out in EN 1990.

AC1 (2)P The means of executing the protective treatment undertaken off-site and on-site shall be in accordance with EN 1090. **AC1**

NOTE EN 1090 lists the factors affecting execution that need to be specified during design.

- (3) Parts susceptible to corrosion, mechanical wear or fatigue should be designed such that inspection, maintenance and reconstruction can be carried out satisfactorily and access is available for in-service inspection and maintenance.

(4)B For building structures no fatigue assessment is normally required except as follows:

- a) Members supporting lifting appliances or rolling loads
- b) Members subject to repeated stress cycles from vibrating machinery
- c) Members subject to wind-induced vibrations
- d) Members subject to crowd-induced oscillations

Ⓐ₁ (5)P For elements that cannot be inspected an appropriate corrosion allowance shall be included. Ⓐ₁

(6)B Corrosion protection does not need to be applied to internal building structures, if the internal relative humidity does not exceed 80%.

5 Structural analysis

5.1 Structural modelling for analysis

5.1.1 Structural modelling and basic assumptions

Ⓐ₁ (1)P Analysis shall be based upon calculation models of the structure that are appropriate for the limit state under consideration. Ⓐ₁

(2) The calculation model and basic assumptions for the calculations should reflect the structural behaviour at the relevant limit state with appropriate accuracy and reflect the anticipated type of behaviour of the cross sections, members, joints and bearings.

Ⓐ₁ (3)P The method used for the analysis shall be consistent with the design assumptions. Ⓐ₁

(4)B For the structural modelling and basic assumptions for components of buildings see also EN 1993-1-5 and EN 1993-1-11.

5.1.2 Joint modelling

(1) The effects of the behaviour of the joints on the distribution of internal forces and moments within a structure, and on the overall deformations of the structure, may generally be neglected, but where such effects are significant (such as in the case of semi-continuous joints) they should be taken into account, see EN 1993-1-8.

(2) To identify whether the effects of joint behaviour on the analysis need be taken into account, a distinction may be made between three joint models as follows, see EN 1993-1-8, 5.1.1:

- simple, in which the joint may be assumed not to transmit bending moments;
- continuous, in which the behaviour of the joint may be assumed to have no effect on the analysis;
- semi-continuous, in which the behaviour of the joint needs to be taken into account in the analysis

(3) The requirements of the various types of joints are given in EN 1993-1-8.

5.1.3 Ground-structure interaction

(1) Account should be taken of the deformation characteristics of the supports where significant.

NOTE EN 1997 gives guidance for calculation of soil-structure interaction.

5.2 Global analysis

5.2.1 Effects of deformed geometry of the structure

- (1) The internal forces and moments may generally be determined using either:
- first-order analysis, using the initial geometry of the structure or
 - second-order analysis, taking into account the influence of the deformation of the structure.
- (2) The effects of the deformed geometry (second-order effects) should be considered if they increase the action effects significantly or modify significantly the structural behaviour.
- (3) First order analysis may be used for the structure, if the increase of the relevant internal forces or moments or any other change of structural behaviour caused by deformations can be neglected. This condition may be assumed to be fulfilled, if the following criterion is satisfied:

$$\alpha_{cr} = \frac{F_{cr}}{F_{Ed}} \geq 10 \quad \text{for elastic analysis}$$

$$\alpha_{cr} = \frac{F_{cr}}{F_{Ed}} \geq 15 \quad \text{for plastic analysis}$$
(5.1)

where α_{cr} is the factor by which the design loading would have to be increased to cause elastic instability in a global mode

F_{Ed} is the design loading on the structure

F_{cr} is the elastic critical buckling load for global instability mode based on initial elastic stiffnesses

NOTE A greater limit for α_{cr} for plastic analysis is given in equation (5.1) because structural behaviour may be significantly influenced by non linear material properties in the ultimate limit state (e.g. where a frame forms plastic hinges with moment redistributions or where significant non linear deformations from semi-rigid joints occur). Where substantiated by more accurate approaches the National Annex may give a lower limit for α_{cr} for certain types of frames.

(4)B Portal frames with shallow roof slopes and beam-and-column type plane frames in buildings may be checked for sway mode failure with first order analysis if the criterion (5.1) is satisfied for each storey. In these structures α_{cr} may be calculated using the following approximative formula, provided that the axial compression in the beams or rafters is not significant:

$$\alpha_{cr} = \left(\frac{H_{Ed}}{V_{Ed}} \right) \left(\frac{h}{\delta_{H,Ed}} \right)$$
(5.2)

where H_{Ed} is the design value of the horizontal reaction at the bottom of the storey to the horizontal loads and fictitious horizontal loads, see 5.3.2(7)

V_{Ed} is the total design vertical load on the structure on the bottom of the storey

$\delta_{H,Ed}$ is the horizontal displacement at the top of the storey, relative to the bottom of the storey, when the frame is loaded with horizontal loads (e.g. wind) and fictitious horizontal loads which are applied at each floor level

h is the storey height

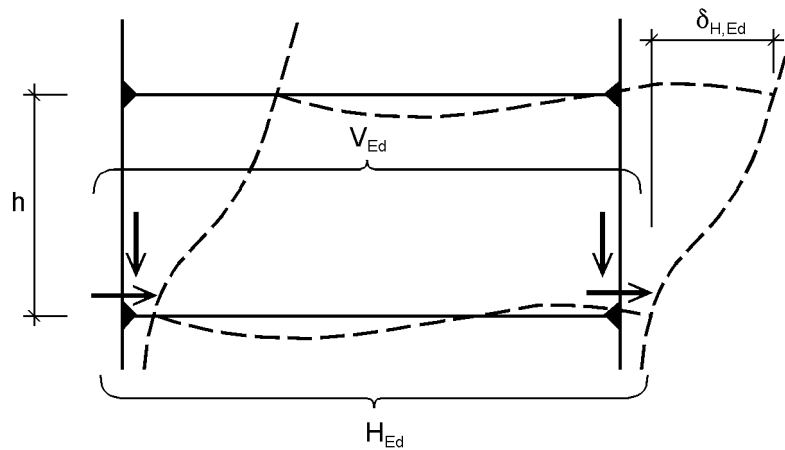

Figure 5.1: Notations for 5.2.1(2)

NOTE 1B For the application of (4)B in the absence of more detailed information a roof slope may be taken to be shallow if it is not steeper than 1:2 (26°).

NOTE 2B For the application of (4)B in the absence of more detailed information the axial compression in the beams or rafters may be assumed to be significant if

$$\bar{\lambda} \geq 0,3 \sqrt{\frac{A f_y}{N_{Ed}}} \quad (5.3)$$

where N_{Ed} is the design value of the compression force,

$\bar{\lambda}$ is the inplane non dimensional slenderness calculated for the beam or rafters considered as hinged at its ends of the system length measured along the beams or rafters.

(5) The effects of shear lag and of local buckling on the stiffness should be taken into account if this significantly influences the global analysis, see EN 1993-1-5.

NOTE For rolled sections and welded sections with similar dimensions shear lag effects may be neglected.

(6) The effects on the global analysis of the slip in bolt holes and similar deformations of connection devices like studs and anchor bolts on action effects should be taken into account, where relevant and significant.

5.2.2 Structural stability of frames

(1) If according to 5.2.1 the influence of the deformation of the structure has to be taken into account (2) to (6) should be applied to consider these effects and to verify the structural stability.

(2) The verification of the stability of frames or their parts should be carried out considering imperfections and second order effects.

(3) According to the type of frame and the global analysis, second order effects and imperfections may be accounted for by one of the following methods:

- a) both totally by the global analysis,
- b) partially by the global analysis and partially through individual stability checks of members according to 6.3,
- c) for basic cases by individual stability checks of equivalent members according to 6.3 using appropriate buckling lengths according to the global buckling mode of the structure.

(4) Second order effects may be calculated by using an analysis appropriate to the structure (including step-by-step or other iterative procedures). For frames where the first sway buckling mode is predominant first order elastic analysis should be carried out with subsequent amplification of relevant action effects (e.g. bending moments) by appropriate factors.

(5)B For single storey frames designed on the basis of elastic global analysis second order sway effects due to vertical loads may be calculated by increasing the horizontal loads H_{Ed} (e.g. wind) and equivalent loads $V_{Ed} \phi$ due to imperfections (see 5.3.2(7)) and other possible sway effects according to first order theory by the factor:

$$\frac{1}{1 - \frac{1}{\alpha_{cr}}} \quad (5.4)$$

provided that $\alpha_{cr} \geq 3,0$,

where α_{cr} may be calculated according to (5.2) in 5.2.1(4)B, provided that the roof slope is shallow and that the axial compression in the beams or rafters is not significant as defined in 5.2.1(4)B.

NOTE B For $\alpha_{cr} < 3,0$ a more accurate second order analysis applies.

(6)B For multi-storey frames second order sway effects may be calculated by means of the method given in (5)B provided that all storeys have a similar

- distribution of vertical loads and
- distribution of horizontal loads and
- distribution of frame stiffness with respect to the applied storey shear forces.

NOTE B For the limitation of the method see also 5.2.1(4)B.

(7) In accordance with (3) the stability of individual members should be checked according to the following:

- a) If second order effects in individual members and relevant member imperfections (see 5.3.4) are totally accounted for in the global analysis of the structure, no individual stability check for the members according to 6.3 is necessary.
- b) If second order effects in individual members or certain individual member imperfections (e.g. member imperfections for flexural and/or lateral torsional buckling, see 5.3.4) are not totally accounted for in the global analysis, the individual stability of members should be checked according to the relevant criteria in 6.3 for the effects not included in the global analysis. This verification should take account of end moments and forces from the global analysis of the structure, including global second order effects and global imperfections (see 5.3.2) when relevant and may be based on a buckling length equal to the system length

(8) Where the stability of a frame is assessed by a check with the equivalent column method according to 6.3 the buckling length values should be based on a global buckling mode of the frame accounting for the stiffness behaviour of members and joints, the presence of plastic hinges and the distribution of compressive forces under the design loads. In this case internal forces to be used in resistance checks are calculated according to first order theory without considering imperfections.

NOTE The National Annex may give information on the scope of application.

5.3 Imperfections

5.3.1 Basis

(1) Appropriate allowances should be incorporated in the structural analysis to cover the effects of imperfections, including residual stresses and geometrical imperfections such as lack of verticality, lack of

straightness, lack of flatness, lack of fit and any minor eccentricities present in joints of the unloaded structure.

(2) Equivalent geometric imperfections, see 5.3.2 and 5.3.3, should be used, with values which reflect the possible effects of all type of imperfections unless these effects are included in the resistance formulae for member design, see section 5.3.4.

(3) The following imperfections should be taken into account:

- a) global imperfections for frames and bracing systems
- b) local imperfections for individual members

5.3.2 Imperfections for global analysis of frames

(1) The assumed shape of global imperfections and local imperfections may be derived from the elastic buckling mode of a structure in the plane of buckling considered.

(2) Both in and out of plane buckling including torsional buckling with symmetric and asymmetric buckling shapes should be taken into account in the most unfavourable direction and form.

(3) For frames sensitive to buckling in a sway mode the effect of imperfections should be allowed for in frame analysis by means of an equivalent imperfection in the form of an initial sway imperfection and individual bow imperfections of members. The imperfections may be determined from:

a) global initial sway imperfections, see Figure 5.2:

$$\phi = \phi_0 \alpha_h \alpha_m \quad (5.5)$$

where ϕ_0 is the basic value: $\phi_0 = 1/200$

α_h is the reduction factor for height h applicable to columns:

$$\alpha_h = \frac{2}{\sqrt{h}} \text{ but } \frac{2}{3} \leq \alpha_h \leq 1,0$$

h is the height of the structure in meters

α_m is the reduction factor for the number of columns in a row: $\alpha_m = \sqrt{0,5 \left(1 + \frac{1}{m}\right)}$

m is the number of columns in a row including only those columns which carry a vertical load N_{Ed} not less than 50% of the average value of the column in the vertical plane considered

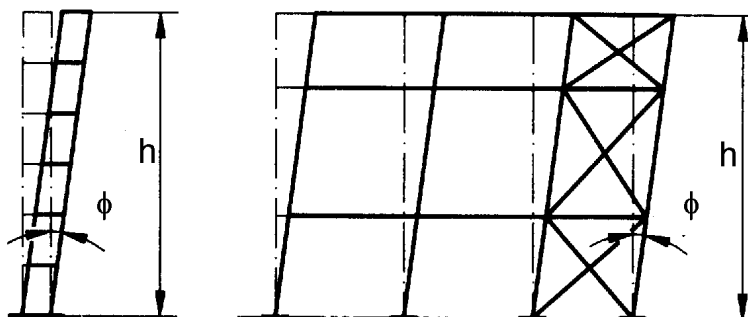

Figure 5.2: Equivalent sway imperfections

b) relative initial local bow imperfections of members for flexural buckling

$$e_0 / L \quad (5.6)$$

where L is the member length

NOTE The values e_0 / L may be chosen in the National Annex. Recommended values are given in Table 5.1.

Table 5.1: Design values of initial local bow imperfection e_0 / L

Buckling curve acc. to Table 6.1	elastic analysis	plastic analysis
	e_0 / L	e_0 / L
a ₀	1 / 350	1 / 300
a	1 / 300	1 / 250
b	1 / 250	1 / 200
c	1 / 200	1 / 150
d	1 / 150	1 / 100

(4)B For building frames sway imperfections may be disregarded where

$$H_{Ed} \geq 0,15 V_{Ed} \tag{5.7}$$

(5)B For the determination of horizontal forces to floor diaphragms the configuration of imperfections as given in Figure 5.3 should be applied, where ϕ is a sway imperfection obtained from (5.5) assuming a single storey with height h , see (3) a).

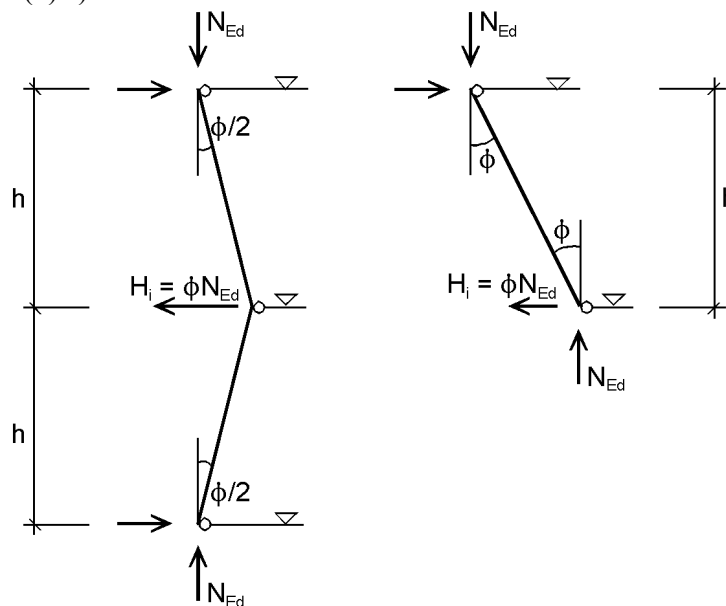

Figure 5.3: Configuration of sway imperfections ϕ for horizontal forces on floor diaphragms

(6) When performing the global analysis for determining end forces and end moments to be used in member checks according to 6.3 local bow imperfections may be neglected. However for frames sensitive to second order effects local bow imperfections of members additionally to global sway imperfections (see 5.2.1(3)) should be introduced in the structural analysis of the frame for each compressed member where the following conditions are met:

- at least one moment resistant joint at one member end

- $\bar{\lambda} > 0,5 \sqrt{\frac{A f_y}{N_{Ed}}}$ (5.8)

where N_{Ed} is the design value of the compression force

and $\bar{\lambda}$ is the in-plane non-dimensional slenderness calculated for the member considered as hinged at its ends

NOTE Local bow imperfections are taken into account in member checks, see 5.2.2 (3) and 5.3.4.

(7) The effects of initial sway imperfections and local bow imperfections may be replaced by systems of equivalent horizontal forces, introduced for each column, see Figure 5.3 and Figure 5.4.

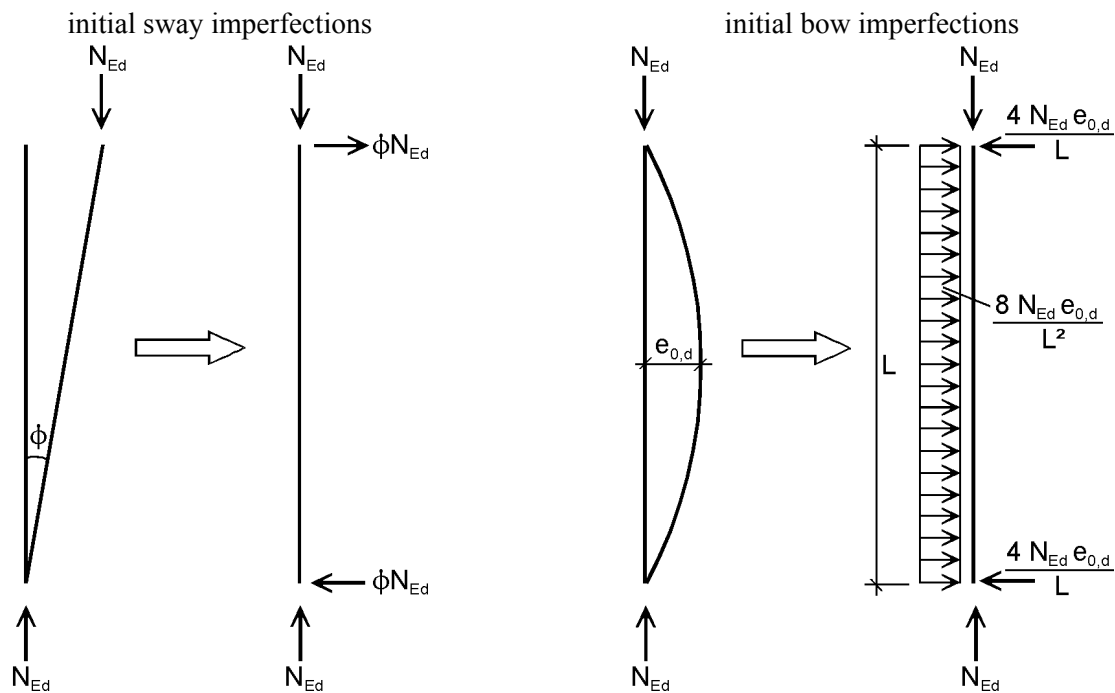
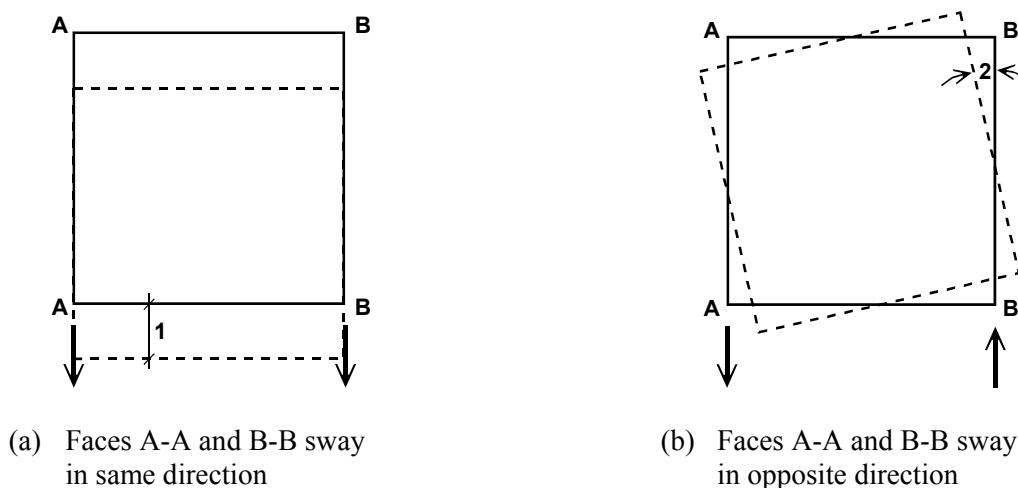

Figure 5.4: Replacement of initial imperfections by equivalent horizontal forces

(8) These initial sway imperfections should apply in all relevant horizontal directions, but need only be considered in one direction at a time.

(9)B Where, in multi-storey beam-and-column building frames, equivalent forces are used they should be applied at each floor and roof level.

(10) The possible torsional effects on a structure caused by anti-symmetric sways at the two opposite faces, should also be considered, see Figure 5.5.



(a) Faces A-A and B-B sway in same direction

(b) Faces A-A and B-B sway in opposite direction

1 translational sway
2 rotational sway

Figure 5.5: Translational and torsional effects (plan view)

(11) As an alternative to (3) and (6) the shape of the elastic critical buckling mode η_{cr} of the structure may be applied as a unique global and local imperfection. The amplitude of this imperfection may be determined from:

$$\eta_{init} = e_0 \frac{N_{cr}}{EI \eta_{cr,max}^*} \eta_{cr} = \frac{e_0}{\bar{\lambda}^2} \frac{N_{Rk}}{EI \eta_{cr,max}^*} \eta_{cr} \quad (5.9)$$

where:

$$e_0 = \alpha (\bar{\lambda} - 0,2) \frac{M_{Rk}}{N_{Rk}} \frac{1 - \chi \bar{\lambda}^2}{1 - \chi \bar{\lambda}^2} \quad \text{for } \bar{\lambda} > 0,2 \quad (5.10)$$

and $\bar{\lambda} = \sqrt{\frac{\alpha_{ult,k}}{\alpha_{cr}}}$ is the relative slenderness of the structure (5.11)

α is the imperfection factor for the relevant buckling curve, see Table 6.1 and Table 6.2;

χ is the reduction factor for the relevant buckling curve depending on the relevant cross-section, see 6.3.1;

$\alpha_{ult,k}$ is the minimum force amplifier for the axial force configuration N_{Ed} in members to reach the characteristic resistance N_{Rk} of the most axially stressed cross section without taking buckling into account

α_{cr} is the minimum force amplifier for the axial force configuration N_{Ed} in members to reach the elastic critical buckling

M_{Rk} is the characteristic moments resistance of the critical cross section, e.g. $M_{el,Rk}$ or $M_{pl,Rk}$ as relevant

N_{Rk} is the characteristic resistance to normal force of the critical cross section, i.e. $N_{pl,Rk}$

$EI \eta_{cr,max}^*$ is the bending moment due to η_{cr} at the critical cross section

η_{cr} is the shape of elastic critical buckling mode

NOTE 1 For calculating the amplifiers $\alpha_{ult,k}$ and α_{cr} the members of the structure may be considered to be loaded by axial forces N_{Ed} only that result from the first order elastic analysis of the structure for the design loads.

NOTE 2 The National Annex may give information for the scope of application of (11).

5.3.3 Imperfection for analysis of bracing systems

(1) In the analysis of bracing systems which are required to provide lateral stability within the length of beams or compression members the effects of imperfections should be included by means of an equivalent geometric imperfection of the members to be restrained, in the form of an initial bow imperfection:

$$e_0 = \alpha_m L / 500 \quad (5.12)$$

where L is the span of the bracing system

and $\alpha_m = \sqrt{0,5 \left(1 + \frac{1}{m} \right)}$

in which m is the number of members to be restrained.

(2) For convenience, the effects of the initial bow imperfections of the members to be restrained by a bracing system, may be replaced by the equivalent stabilizing force as shown in Figure 5.6:

$$q_d = \sum N_{Ed} 8 \frac{e_0 + \delta_q}{L^2} \quad (5.13)$$

where δ_q is the inplane deflection of the bracing system due to q plus any external loads calculated from first order analysis

NOTE δ_q may be taken as 0 if second order theory is used.

(3) Where the bracing system is required to stabilize the compression flange of a beam of constant height, the force N_{Ed} in Figure 5.6 may be obtained from:

$$N_{Ed} = M_{Ed} / h \quad (5.14)$$

where M_{Ed} is the maximum moment in the beam

and h is the overall depth of the beam.

NOTE Where a beam is subjected to external compression N_{Ed} should include a part of the compression force.

(4) At points where beams or compression members are spliced, it should also be verified that the bracing system is able to resist a local force equal to $\alpha_m N_{Ed} / 100$ applied to it by each beam or compression member which is spliced at that point, and to transmit this force to the adjacent points at which that beam or compression member is restrained, see Figure 5.7.

(5) For checking for the local force according to clause (4), any external loads acting on bracing systems should also be included, but the forces arising from the imperfection given in (1) may be omitted.

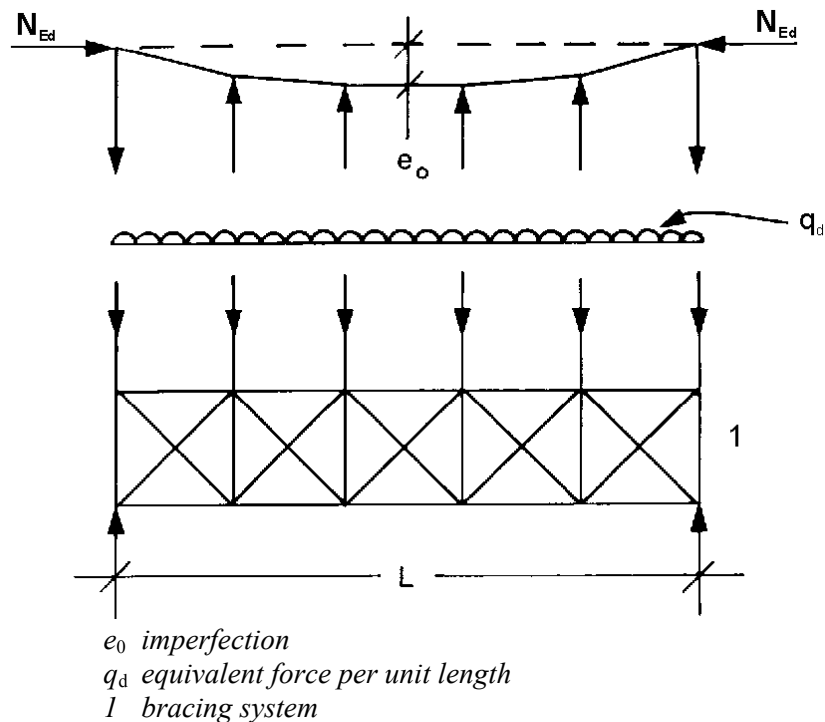

The force N_{Ed} is assumed uniform within the span L of the bracing system.
 For non-uniform forces this is slightly conservative.

Figure 5.6: Equivalent stabilizing force

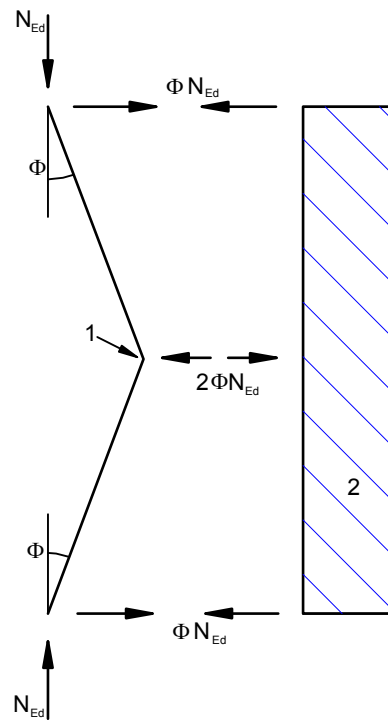

$$\Phi = \alpha_m \Phi_0 \quad : \quad \Phi_0 = 1 / 200$$

$$2\Phi N_{Ed} = \alpha_m N_{Ed} / 100$$

1 splice

2 bracing system

Figure 5.7: Bracing forces at splices in compression elements

5.3.4 Member imperfections

- (1) The effects of local bow imperfections of members are incorporated within the formulas given for buckling resistance for members, see section 6.3.
- (2) Where the stability of members is accounted for by second order analysis according to 5.2.2(7)a) for compression members imperfections e_0 according to 5.3.2(3)b), 5.3.2(5) or 5.3.2(6) should be considered.
- (3) For a second order analysis taking account of lateral torsional buckling of a member in bending the imperfections may be adopted as $ke_{0,d}$, where $e_{0,d}$ is the equivalent initial bow imperfection of the weak axis of the profile considered. In general an additional torsional imperfection need not to be allowed for.

NOTE The National Annex may choose the value of k . The value $k = 0,5$ is recommended.

5.4 Methods of analysis considering material non-linearities

5.4.1 General

- (1) The internal forces and moments may be determined using either
 - a) elastic global analysis
 - b) plastic global analysis.

NOTE For finite element model (FEM) analysis see EN 1993-1-5.

- (2) Elastic global analysis may be used in all cases.

(3) Plastic global analysis may be used only where the structure has sufficient rotation capacity at the actual locations of the plastic hinges, whether this is in the members or in the joints. Where a plastic hinge occurs in a member, the member cross sections should be double symmetric or single symmetric with a plane of symmetry in the same plane as the rotation of the plastic hinge and it should satisfy the requirements specified in 5.6. Where a plastic hinge occurs in a joint the joint should either have sufficient strength to ensure the hinge remains in the member or should be able to sustain the plastic resistance for a sufficient rotation, see EN 1993-1-8.

(4)B As a simplified method for a limited plastic redistribution of moments in continuous beams where following an elastic analysis some peak moments exceed the plastic bending resistance of 15 % maximum, the parts in excess of these peak moments may be redistributed in any member, provided, that:

- a) the internal forces and moments in the frame remain in equilibrium with the applied loads, and
- b) all the members in which the moments are reduced have Class 1 or Class 2 cross-sections (see 5.5), and
- c) lateral torsional buckling of the members is prevented.

5.4.2 Elastic global analysis

(1) Elastic global analysis should be based on the assumption that the stress-strain behaviour of the material is linear, whatever the stress level is.

NOTE For the choice of a semi-continuous joint model see 5.1.2(2) to (4).

(2) Internal forces and moments may be calculated according to elastic global analysis even if the resistance of a cross section is based on its plastic resistance, see 6.2.

(3) Elastic global analysis may also be used for cross sections the resistances of which are limited by local buckling, see 6.2.

5.4.3 Plastic global analysis

(1) Plastic global analysis allows for the effects of material non-linearity in calculating the action effects of a structural system. The behaviour should be modelled by one of the following methods:

- by elastic-plastic analysis with plastified sections and/or joints as plastic hinges,
- by non-linear plastic analysis considering the partial plastification of members in plastic zones,
- by rigid plastic analysis neglecting the elastic behaviour between hinges.

(2) Plastic global analysis may be used where the members are capable of sufficient rotation capacity to enable the required redistributions of bending moments to develop, see 5.5 and 5.6.

(3) Plastic global analysis should only be used where the stability of members at plastic hinges can be assured, see 6.3.5.

(4) The bi-linear stress-strain relationship indicated in Figure 5.8 may be used for the grades of structural steel specified in section 3. Alternatively, a more precise relationship may be adopted, see EN 1993-1-5.

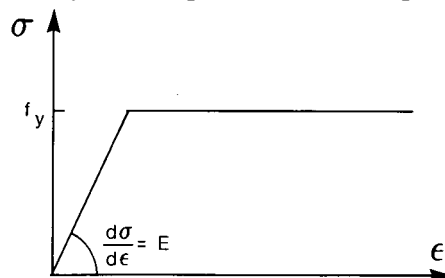

Figure 5.8: Bi-linear stress-strain relationship

- (5) Rigid plastic analysis may be applied if no effects of the deformed geometry (e.g. second-order effects) have to be considered. In this case joints are classified only by strength, see EN 1993-1-8.
- (6) The effects of deformed geometry of the structure and the structural stability of the frame should be verified according to the principles in 5.2.

NOTE The maximum resistance of a frame with significantly deformed geometry may occur before all hinges of the first order collapse mechanism have formed.

5.5 Classification of cross sections

5.5.1 Basis

- (1) The role of cross section classification is to identify the extent to which the resistance and rotation capacity of cross sections is limited by its local buckling resistance.

5.5.2 Classification

- (1) Four classes of cross-sections are defined, as follows:
- Class 1 cross-sections are those which can form a plastic hinge with the rotation capacity required from plastic analysis without reduction of the resistance.
 - Class 2 cross-sections are those which can develop their plastic moment resistance, but have limited rotation capacity because of local buckling.
 - Class 3 cross-sections are those in which the stress in the extreme compression fibre of the steel member assuming an elastic distribution of stresses can reach the yield strength, but local buckling is liable to prevent development of the plastic moment resistance.
 - Class 4 cross-sections are those in which local buckling will occur before the attainment of yield stress in one or more parts of the cross-section.
- (2) In Class 4 cross sections effective widths may be used to make the necessary allowances for reductions in resistance due to the effects of local buckling, see EN 1993-1-5, 5.2.2.
- (3) The classification of a cross-section depends on the width to thickness ratio of the parts subject to compression.
- (4) Compression parts include every part of a cross-section which is either totally or partially in compression under the load combination considered.
- (5) The various compression parts in a cross-section (such as a web or flange) can, in general, be in different classes.
- (6) A cross-section is classified according to the highest (least favourable) class of its compression parts. Exceptions are specified in 6.2.1(10) and 6.2.2.4(1).
- (7) Alternatively the classification of a cross-section may be defined by quoting both the flange classification and the web classification.
- (8) The limiting proportions for Class 1, 2, and 3 compression parts should be obtained from Table 5.2. A part which fails to satisfy the limits for Class 3 should be taken as Class 4.
- (9) Except as given in (10) Class 4 sections may be treated as Class 3 sections if the width to thickness ratios are less than the limiting proportions for Class 3 obtained from Table 5.2 when ε is increased by $\sqrt{\frac{f_y / \gamma_{M0}}{\sigma_{\text{com,Ed}}}}$, where $\sigma_{\text{com,Ed}}$ is the maximum design compressive stress in the part taken from first order or where necessary second order analysis.

- (10) However, when verifying the design buckling resistance of a member using section 6.3, the limiting proportions for Class 3 should always be obtained from Table 5.2.
- (11) Cross-sections with a Class 3 web and Class 1 or 2 flanges may be classified as class 2 cross sections with an effective web in accordance with 6.2.2.4.
- (12) Where the web is considered to resist shear forces only and is assumed not to contribute to the bending and normal force resistance of the cross section, the cross section may be designed as Class 2, 3 or 4 sections, depending only on the flange class.

NOTE For flange induced web buckling see EN 1993-1-5.

5.6 Cross-section requirements for plastic global analysis

- (1) At plastic hinge locations, the cross-section of the member which contains the plastic hinge should have a rotation capacity of not less than the required at the plastic hinge location.
- (2) In a uniform member sufficient rotation capacity may be assumed at a plastic hinge if both the following requirements are satisfied:
- a) the member has Class 1 cross-sections at the plastic hinge location;
 - b) where a transverse force that exceeds 10 % of the shear resistance of the cross section, see 6.2.6, is applied to the web at the plastic hinge location, web stiffeners should be provided within a distance along the member of $h/2$ from the plastic hinge location, where h is the height of the cross section at this location.
- (3) Where the cross-section of the member vary along their length, the following additional criteria should be satisfied:
- a) Adjacent to plastic hinge locations, the thickness of the web should not be reduced for a distance each way along the member from the plastic hinge location of at least $2d$, where d is the clear depth of the web at the plastic hinge location.
 - b) Adjacent to plastic hinge locations, the compression flange should be Class 1 for a distance each way along the member from the plastic hinge location of not less than the greater of:
 - $2d$, where d is as defined in (3)a)
 - the distance to the adjacent point at which the moment in the member has fallen to 0,8 times the plastic moment resistance at the point concerned.
 - c) Elsewhere in the member the compression flange should be class 1 or class 2 and the web should be class 1, class 2 or class 3.
- (4) Adjacent to plastic hinge locations, any fastener holes in tension should satisfy 6.2.5(4) for a distance such as defined in (3)b) each way along the member from the plastic hinge location.
- (5) For plastic design of a frame, regarding cross section requirements, the capacity of plastic redistribution of moments may be assumed sufficient if the requirements in (2) to (4) are satisfied for all members where plastic hinges exist, may occur or have occurred under design loads.
- (6) In cases where methods of plastic global analysis are used which consider the real stress and strain behaviour along the member including the combined effect of local, member and global buckling the requirements (2) to (5) need not be applied.

Table 5.2 (sheet 1 of 3): Maximum width-to-thickness ratios for compression parts

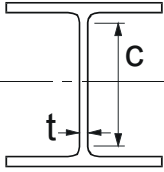
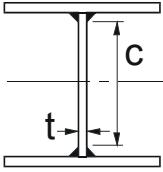
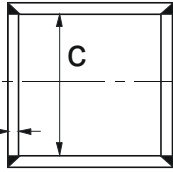
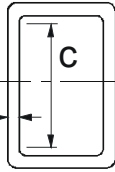
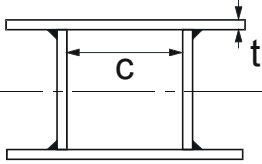
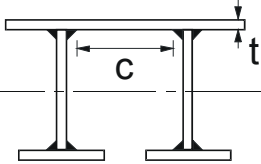
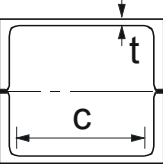
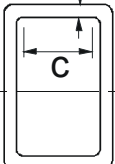
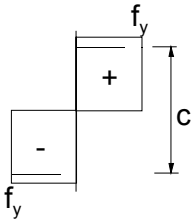
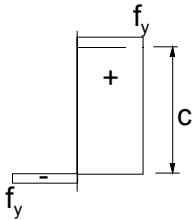
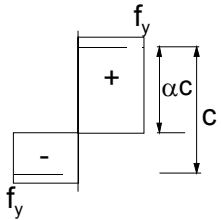
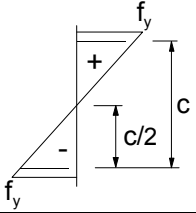
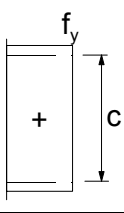
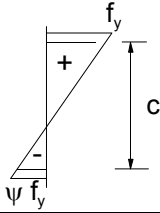
Internal compression parts							
							
							
Class	Part subject to bending	Part subject to compression	Part subject to bending and compression				
Stress distribution in parts (compression positive)							
1	$c/t \leq 72\varepsilon$	$c/t \leq 33\varepsilon$	when $\alpha > 0,5$: $c/t \leq \frac{396\varepsilon}{13\alpha - 1}$ when $\alpha \leq 0,5$: $c/t \leq \frac{36\varepsilon}{\alpha}$				
2	$c/t \leq 83\varepsilon$	$c/t \leq 38\varepsilon$	when $\alpha > 0,5$: $c/t \leq \frac{456\varepsilon}{13\alpha - 1}$ when $\alpha \leq 0,5$: $c/t \leq \frac{41,5\varepsilon}{\alpha}$				
Stress distribution in parts (compression positive)							
3	$c/t \leq 124\varepsilon$	$c/t \leq 42\varepsilon$	when $\psi > -1$: $c/t \leq \frac{42\varepsilon}{0,67 + 0,33\psi}$ when $\psi \leq -1^*$: $c/t \leq 62\varepsilon(1 - \psi)\sqrt{-\psi}$				
$\varepsilon = \sqrt{235/f_y}$	f_y	235	275	355	420	460	
	ε	1,00	0,92	0,81	0,75	0,71	

*) $\psi \leq -1$ applies where either the compression stress $\sigma \leq f_y$ or the tensile strain $\varepsilon_y > f_y/E$

Table 5.2 (sheet 2 of 3): Maximum width-to-thickness ratios for compression parts

Outstand flanges						
						
Rolled sections			Welded sections			
Class	Part subject to compression	Part subject to bending and compression				
		Tip in compression		Tip in tension		
Stress distribution in parts (compression positive)						
1	$c/t \leq 9\epsilon$	$c/t \leq \frac{9\epsilon}{\alpha}$		$c/t \leq \frac{9\epsilon}{\alpha\sqrt{\alpha}}$		
2	$c/t \leq 10\epsilon$	$c/t \leq \frac{10\epsilon}{\alpha}$		$c/t \leq \frac{10\epsilon}{\alpha\sqrt{\alpha}}$		
Stress distribution in parts (compression positive)						
3	$c/t \leq 14\epsilon$	$c/t \leq 21\epsilon\sqrt{k_\sigma}$ For k_σ see EN 1993-1-5				
$\epsilon = \sqrt{235/f_y}$	f_y	235	275	355	420	460
	ϵ	1,00	0,92	0,81	0,75	0,71

Table 5.2 (sheet 3 of 3): Maximum width-to-thickness ratios for compression parts

<p>Refer also to "Outstand flanges" (see sheet 2 of 3)</p>		<p>Angles</p> 		<p>Does not apply to angles in continuous contact with other components</p>			
Class	Section in compression						
Stress distribution across section (compression positive)							
3	$h/t \leq 15\varepsilon : \frac{b+h}{2t} \leq 11,5\varepsilon$						
<p>Tubular sections</p> 							
Class	Section in bending and/or compression						
1	$d/t \leq 50\varepsilon^2$						
2	$d/t \leq 70\varepsilon^2$						
3	$d/t \leq 90\varepsilon^2$ NOTE For $d/t > 90\varepsilon^2$ see EN 1993-1-6.						
$\varepsilon = \sqrt{235/f_y}$	f_y	235	275	355	420	460	
	ε	1,00	0,92	0,81	0,75	0,71	
	ε^2	1,00	0,85	0,66	0,56	0,51	

6 Ultimate limit states

6.1 General

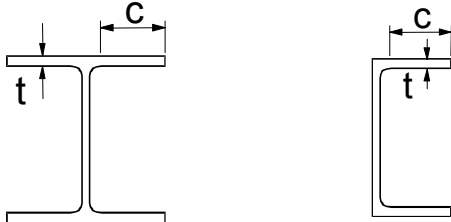
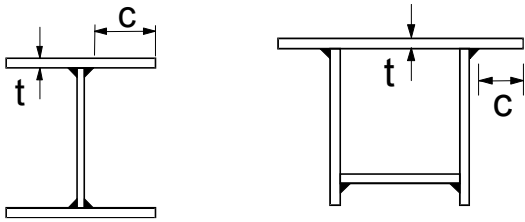
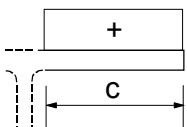
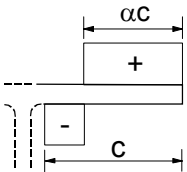
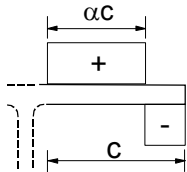
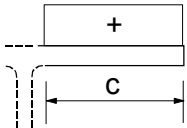
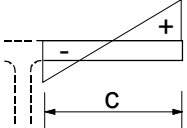
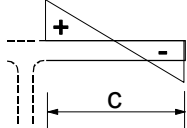
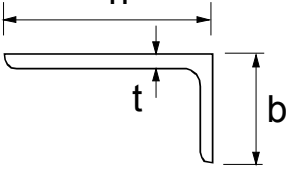
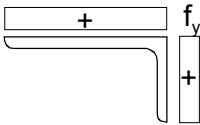
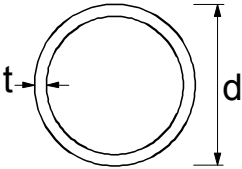
(1) The partial factors γ_M as defined in 2.4.3 should be applied to the various characteristic values of resistance in this section as follows:

- resistance of cross-sections whatever the class is: γ_{M0}
- resistance of members to instability assessed by member checks: γ_{M1}
- resistance of cross-sections in tension to fracture: γ_{M2}
- resistance of joints: see EN 1993-1-8

NOTE 1 For other recommended numerical values see EN 1993 Part 2 to Part 6. For structures not covered by EN 1993 Part 2 to Part 6 the National Annex may define the partial factors γ_{Mi} ; it is recommended to take the partial factors γ_{Mi} from EN 1993-2.

NOTE 2B Partial factors γ_{Mi} for buildings may be defined in the National Annex. The following numerical values are recommended for buildings:

$$\gamma_{M0} = 1,00$$

$$\gamma_{M1} = 1,00$$

$$\gamma_{M2} = 1,25$$

6.2 Resistance of cross-sections

6.2.1 General

AC1 (1)P The design value of an action effect in each cross section shall not exceed the corresponding design resistance and if several action effects act simultaneously the combined effect shall not exceed the resistance for that combination. **AC1**

(2) Shear lag effects and local buckling effects should be included by an effective width according to EN 1993-1-5. Shear buckling effects should also be considered according to EN 1993-1-5.

(3) The design values of resistance should depend on the classification of the cross-section.

(4) Elastic verification according to the elastic resistance may be carried out for all cross sectional classes provided the effective cross sectional properties are used for the verification of class 4 cross sections.

(5) For the elastic verification the following yield criterion for a critical point of the cross section may be used unless other interaction formulae apply, see 6.2.8 to 6.2.10.

$$\left(\frac{\sigma_{x,Ed}}{f_y/\gamma_{M0}} \right)^2 + \left(\frac{\sigma_{z,Ed}}{f_y/\gamma_{M0}} \right)^2 - \left(\frac{\sigma_{x,Ed}}{f_y/\gamma_{M0}} \right) \left(\frac{\sigma_{z,Ed}}{f_y/\gamma_{M0}} \right) + 3 \left(\frac{\tau_{Ed}}{f_y/\gamma_{M0}} \right)^2 \leq 1 \quad (6.1)$$

where $\sigma_{x,Ed}$ is the design value of the local longitudinal stress at the point of consideration

$\sigma_{z,Ed}$ is the design value of the local transverse stress at the point of consideration

τ_{Ed} is the design value of the local shear stress at the point of consideration

NOTE The verification according to (5) can be conservative as it excludes partial plastic stress distribution, which is permitted in elastic design. Therefore it should only be performed where the interaction of on the basis of resistances N_{Rd} , M_{Rd} , V_{Rd} cannot be performed.

(6) The plastic resistance of cross sections should be verified by finding a stress distribution which is in equilibrium with the internal forces and moments without exceeding the yield strength. This stress distribution should be compatible with the associated plastic deformations.

(7) As a conservative approximation for all cross section classes a linear summation of the utilization ratios for each stress resultant may be used. For class 1, class 2 or class 3 cross sections subjected to the combination of N_{Ed} , $M_{y,Ed}$ and $M_{z,Ed}$ this method may be applied by using the following criteria:

$$\frac{N_{Ed}}{N_{Rd}} + \frac{M_{y,Ed}}{M_{y,Rd}} + \frac{M_{z,Ed}}{M_{z,Rd}} \leq 1 \quad (6.2)$$

where N_{Rd} , $M_{y,Rd}$ and $M_{z,Rd}$ are the design values of the resistance depending on the cross sectional classification and including any reduction that may be caused by shear effects, see 6.2.8.

NOTE For class 4 cross sections see 6.2.9.3(2).

(8) Where all the compression parts of a cross-section are at least Class 2, the cross-section may be taken as capable of developing its full plastic resistance in bending.

(9) Where all the compression parts of a cross-section are Class 3, its resistance should be based on an elastic distribution of strains across the cross-section. Compressive stresses should be limited to the yield strength at the extreme fibres.

NOTE The extreme fibres may be assumed at the midplane of the flanges for ULS checks. For fatigue see EN 1993-1-9.

(10) Where yielding first occurs on the tension side of the cross section, the plastic reserves of the tension zone may be utilized by accounting for partial plastification when determining the resistance of a Class 3 cross-section.

6.2.2 Section properties

6.2.2.1 Gross cross-section

(1) The properties of the gross cross-section should be determined using the nominal dimensions. Holes for fasteners need not be deducted, but allowance should be made for larger openings. Splice materials should not be included.

6.2.2.2 Net area

(1) The net area of a cross-section should be taken as its gross area less appropriate deductions for all holes and other openings.

(2) For calculating net section properties, the deduction for a single fastener hole should be the gross cross-sectional area of the hole in the plane of its axis. For countersunk holes, appropriate allowance should be made for the countersunk portion.

(3) Provided that the fastener holes are not staggered, the total area to be deducted for fastener holes should be the maximum sum of the sectional areas of the holes in any cross-section perpendicular to the member axis (see failure plane ② in Figure 6.1).

NOTE The maximum sum denotes the position of the critical fracture line.

(4) Where the fastener holes are staggered, the total area to be deducted for fasteners should be the greater of:

a) the deduction for non-staggered holes given in (3)

$$b) t \left(nd_0 - \sum \frac{s^2}{4p} \right) \quad (6.3)$$

where s is the staggered pitch, the spacing of the centres of two consecutive holes in the chain measured parallel to the member axis;

p is the spacing of the centres of the same two holes measured perpendicular to the member axis;

t is the thickness;

n is the number of holes extending in any diagonal or zig-zag line progressively across the member or part of the member, see Figure 6.1.

d_0 is the diameter of hole

(5) In an angle or other member with holes in more than one plane, the spacing p should be measured along the centre of thickness of the material (see Figure 6.2).

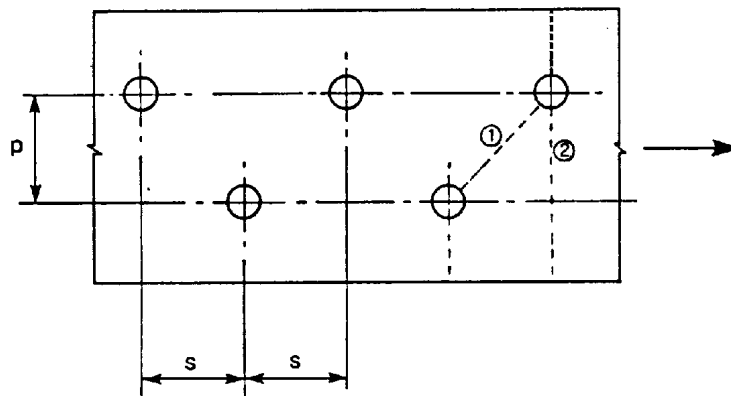

Figure 6.1: Staggered holes and critical fracture lines 1 and 2

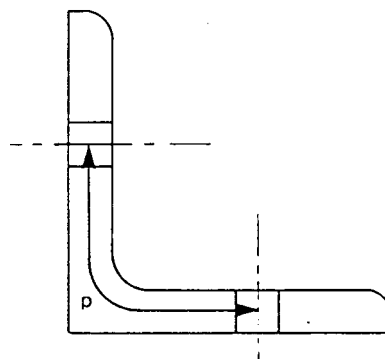

Figure 6.2: Angles with holes in both legs

6.2.2.3 Shear lag effects

(1) The calculation of the effective widths is covered in EN 1993-1-5.

(2) In class 4 sections the interaction between shear lag and local buckling should be considered according to EN 1993-1-5.

NOTE For cold formed thin gauge members see EN 1993-1-3.

6.2.2.4 Effective properties of cross sections with class 3 webs and class 1 or 2 flanges

(1) Where cross-sections with a class 3 web and class 1 or 2 flanges are classified as effective Class 2 cross-sections, see 5.5.2(11), the proportion of the web in compression should be replaced by a part of $20\epsilon t_w$ adjacent to the compression flange, with another part of $20\epsilon t_w$ adjacent to the plastic neutral axis of the effective cross-section in accordance with Figure 6.3.

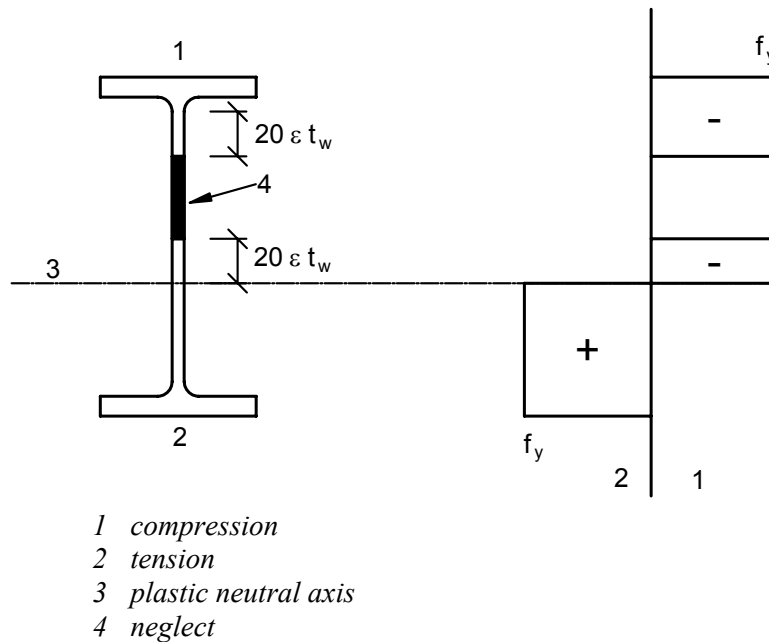

Figure 6.3: Effective class 2 web

6.2.2.5 Effective cross-section properties of Class 4 cross-sections

- (1) The effective cross-section properties of Class 4 cross-sections should be based on the effective widths of the compression parts.
- (2) For cold formed thin walled sections see 1.1.2(1) and EN 1993-1-3.
- (3) The effective widths of planar compression parts should be obtained from EN 1993-1-5.
- (4) Where a class 4 cross section is subjected to an axial compression force, the method given in EN 1993-1-5 should be used to determine the possible shift e_N of the centroid of the effective area A_{eff} relative to the centre of gravity of the gross cross section and the resulting additional moment:

$$\Delta M_{Ed} = N_{Ed} e_N \quad (6.4)$$

NOTE The sign of the additional moment depends on the effect in the combination of internal forces and moments, see 6.2.9.3(2).

- (5) For circular hollow sections with class 4 cross sections see EN 1993-1-6.

6.2.3 Tension

AC1 (1)P The design value of the tension force N_{Ed} at each cross section shall satisfy: AC1

$$\frac{N_{Ed}}{N_{t,Rd}} \leq 1,0 \quad (6.5)$$

(2) For sections with holes the design tension resistance $N_{t,Rd}$ should be taken as the smaller of:

a) the design plastic resistance of the gross cross-section

$$N_{pl,Rd} = \frac{A f_y}{\gamma_{M0}} \quad (6.6)$$

b) the design ultimate resistance of the net cross-section at holes for fasteners

$$N_{u,Rd} = \frac{0,9A_{net} f_u}{\gamma_{M2}} \quad (6.7)$$

(3) Where capacity design is requested, see EN 1998, the design plastic resistance $N_{pl,Rd}$ (as given in 6.2.3(2) a)) should be less than the design ultimate resistance of the net section at fasteners holes $N_{u,Rd}$ (as given in 6.2.3(2) b)).

(4) In category C connections (see EN 1993-1-8, 3.4.2(1), the design tension resistance $N_{t,Rd}$ in 6.2.3(1) of the net section at holes for fasteners should be taken as $N_{net,Rd}$, where:

$$N_{net,Rd} = \frac{A_{net} f_y}{\gamma_{M0}} \quad (6.8)$$

(5) For angles connected through one leg, see also EN 1993-1-8, 3.6.3. Similar consideration should also be given to other type of sections connected through outstands.

6.2.4 Compression

AC1 (1)P The design value of the compression force N_{Ed} at each cross-section shall satisfy: AC1

$$\frac{N_{Ed}}{N_{c,Rd}} \leq 1,0 \quad (6.9)$$

(2) The design resistance of the cross-section for uniform compression $N_{c,Rd}$ should be determined as follows:

$$N_{c,Rd} = \frac{A f_y}{\gamma_{M0}} \quad \text{for class 1, 2 or 3 cross-sections} \quad (6.10)$$

$$N_{c,Rd} = \frac{A_{eff} f_y}{\gamma_{M0}} \quad \text{for class 4 cross-sections} \quad (6.11)$$

(3) Fastener holes except for oversize and slotted holes as defined in EN 1090 need not be allowed for in compression members, provided that they are filled by fasteners.

(4) In the case of unsymmetrical Class 4 sections, the method given in 6.2.9.3 should be used to allow for the additional moment ΔM_{Ed} due to the eccentricity of the centroidal axis of the effective section, see 6.2.2.5(4).

6.2.5 Bending moment

AC1 (1)P The design value of the bending moment M_{Ed} at each cross-section shall satisfy: AC1

$$\frac{M_{Ed}}{M_{c,Rd}} \leq 1,0 \quad (6.12)$$

where $M_{c,Rd}$ is determined considering fastener holes, see (4) to (6).

(2) The design resistance for bending about one principal axis of a cross-section is determined as follows:

$$M_{c,Rd} = M_{pl,Rd} = \frac{W_{pl} f_y}{\gamma_{M0}} \quad \text{for class 1 or 2 cross sections} \quad (6.13)$$

$$M_{c,Rd} = M_{el,Rd} = \frac{W_{el,min} f_y}{\gamma_{M0}} \quad \text{for class 3 cross sections} \quad (6.14)$$

$$M_{c,Rd} = \frac{W_{eff,min} f_y}{\gamma_{M0}} \quad \text{for class 4 cross sections} \quad (6.15)$$

where $W_{el,min}$ and $W_{eff,min}$ corresponds to the fibre with the maximum elastic stress.

(3) For bending about both axes, the methods given in 6.2.9 should be used.

(4) Fastener holes in the tension flange may be ignored provided that for the tension flange:

$$\frac{A_{f,net} 0,9 f_u}{\gamma_{M2}} \geq \frac{A_f f_y}{\gamma_{M0}} \quad (6.16)$$

where A_f is the area of the tension flange.

NOTE The criterion in (4) provides capacity design (see 1.5.8) in the region of plastic hinges.

(5) Fastener holes in tension zone of the web need not be allowed for, provided that the limit given in (4) is satisfied for the complete tension zone comprising the tension flange plus the tension zone of the web.

(6) Fastener holes except for oversize and slotted holes in compression zone of the cross-section need not be allowed for, provided that they are filled by fasteners.

6.2.6 Shear

AC1 (1)P The design value of the shear force V_{Ed} at each cross section shall satisfy: AC1

$$\frac{V_{Ed}}{V_{c,Rd}} \leq 1,0 \quad (6.17)$$

where $V_{c,Rd}$ is the design shear resistance. For plastic design $V_{c,Rd}$ is the design plastic shear resistance $V_{pl,Rd}$ as given in (2). For elastic design $V_{c,Rd}$ is the design elastic shear resistance calculated using (4) and (5).

(2) In the absence of torsion the design plastic shear resistance is given by:

$$V_{pl,Rd} = \frac{A_v (f_y / \sqrt{3})}{\gamma_{M0}} \quad (6.18)$$

where A_v is the shear area.

(3) The shear area A_v may be taken as follows:

a) rolled I and H sections, load parallel to web $A - 2bt_f + (t_w + 2r)t_f$ but not less than $\eta h_w t_w$

b) rolled channel sections, load parallel to web $A - 2bt_f + (t_w + r)t_f$

c) rolled T-section, load parallel to web $0,9(A - bt_f)$

d) welded I, H and box sections, load parallel to web $\eta \sum (h_w t_w)$

e) welded I, H, channel and box sections, load parallel to flanges $A - \sum (h_w t_w)$

f) rolled rectangular hollow sections of uniform thickness:

load parallel to depth $Ah/(b+h)$

load parallel to width $Ab/(b+h)$

g) circular hollow sections and tubes of uniform thickness $2A/\pi$

where A is the crosssectional area;

b is the overall breadth;

h is the overall depth;

h_w is the depth of the web;

r is the root radius;

t_f is the flange thickness;

t_w is the web thickness (If the web thickness is not constant, t_w should be taken as the minimum thickness.).

η see EN 1993-1-5.

NOTE η may be conservatively taken equal 1,0.

(4) For verifying the design elastic shear resistance $V_{c,Rd}$ the following criterion for a critical point of the cross section may be used unless the buckling verification in section 5 of EN 1993-1-5 applies:

$$\frac{\tau_{Ed}}{f_y / (\sqrt{3} \gamma_{M0})} \leq 1,0 \quad (6.19)$$

where τ_{Ed} may be obtained from: $\tau_{Ed} = \frac{V_{Ed} S}{I t}$ (6.20)

where V_{Ed} is the design value of the shear force

S is the first moment of area about the centroidal axis of that portion of the cross-section between the point at which the shear is required and the boundary of the cross-section

I is second moment of area of the whole cross section

t is the thickness at the examined point

NOTE The verification according to (4) is conservative as it excludes partial plastic shear distribution, which is permitted in elastic design, see (5). Therefore it should only be carried out where the verification on the basis of $V_{c,Rd}$ according to equation (6.17) cannot be performed.

(5) For I- or H-sections the shear stress in the web may be taken as:

$$\tau_{Ed} = \frac{V_{Ed}}{A_w} \quad \text{if } A_f / A_w \geq 0,6 \quad (6.21)$$

where A_f is the area of one flange;

A_w is the area of the web: $A_w = h_w t_w$.

(6) In addition the shear buckling resistance for webs without intermediate stiffeners should be according to section 5 of EN 1993-1-5, if

$$\frac{h_w}{t_w} > 72 \frac{\varepsilon}{\eta} \quad (6.22)$$

For η see section 5 of EN 1993-1-5.

NOTE η may be conservatively taken equal to 1,0.

(7) Fastener holes need not be allowed for in the shear verification except in verifying the design shear resistance at connection zones as given in EN 1993-1-8.

(8) Where the shear force is combined with a torsional moment, the plastic shear resistance $V_{pl,Rd}$ should be reduced as specified in 6.2.7(9).

6.2.7 Torsion

(1) For members subject to torsion for which distortional deformations may be disregarded the design value of the torsional moment T_{Ed} at each cross-section should satisfy:

$$\frac{T_{Ed}}{T_{Rd}} \leq 1,0 \quad (6.23)$$

where T_{Rd} is the design torsional resistance of the cross section.

(2) The total torsional moment T_{Ed} at any cross-section should be considered as the sum of two internal effects:

$$T_{Ed} = T_{t,Ed} + T_{w,Ed} \quad (6.24)$$

where $T_{t,Ed}$ is the internal St. Venant torsion;

$T_{w,Ed}$ is the internal warping torsion.

(3) The values of $T_{t,Ed}$ and $T_{w,Ed}$ at any cross-section may be determined from T_{Ed} by elastic analysis, taking account of the section properties of the member, the conditions of restraint at the supports and the distribution of the actions along the member.

(4) The following stresses due to torsion should be taken into account:

- the shear stresses $\tau_{t,Ed}$ due to St. Venant torsion $T_{t,Ed}$
- the direct stresses $\sigma_{w,Ed}$ due to the bimoment B_{Ed} and shear stresses $\tau_{w,Ed}$ due to warping torsion $T_{w,Ed}$

(5) For the elastic verification the yield criterion in 6.2.1(5) may be applied.

(6) For determining the plastic moment resistance of a cross section due to bending and torsion only torsion effects B_{Ed} should be derived from elastic analysis, see (3).

(7) As a simplification, in the case of a member with a closed hollow cross-section, such as a structural hollow section, it may be assumed that the effects of torsional warping can be neglected. Also as a simplification, in the case of a member with open cross section, such as I or H, it may be assumed that the effects of St. Venant torsion can be neglected.

(8) For the calculation of the resistance T_{Rd} of closed hollow sections the design shear strength of the individual parts of the cross section according to EN 1993-1-5 should be taken into account.

(9) For combined shear force and torsional moment the plastic shear resistance accounting for torsional effects should be reduced from $V_{pl,Rd}$ to $V_{pl,T,Rd}$ and the design shear force should satisfy:

$$\frac{V_{Ed}}{V_{pl,T,Rd}} \leq 1,0 \quad (6.25)$$

in which $V_{pl,T,Rd}$ may be derived as follows:

– for an I or H section:

$$V_{pl,T,Rd} = \sqrt{1 - \frac{\tau_{t,Ed}}{1,25 (f_y/\sqrt{3})/\gamma_{M0}}} V_{pl,Rd} \quad (6.26)$$

– for a channel section:

$$V_{pl,T,Rd} = \left[\sqrt{1 - \frac{\tau_{t,Ed}}{1,25 (f_y/\sqrt{3})/\gamma_{M0}}} - \frac{\tau_{w,Ed}}{(f_y/\sqrt{3})/\gamma_{M0}} \right] V_{pl,Rd} \quad (6.27)$$

– for a structural hollow section:

$$V_{pl,T,Rd} = \left[1 - \frac{\tau_{t,Ed}}{(f_y/\sqrt{3})/\gamma_{M0}} \right] V_{pl,Rd} \quad (6.28)$$

where $V_{pl,Rd}$ is given in 6.2.6.

6.2.8 Bending and shear

(1) Where the shear force is present allowance should be made for its effect on the moment resistance.

(2) Where the shear force is less than half the plastic shear resistance its effect on the moment resistance may be neglected except where shear buckling reduces the section resistance, see EN 1993-1-5.

(3) Otherwise the reduced moment resistance should be taken as the design resistance of the cross-section, calculated using a reduced yield strength

$$(1 - \rho) f_y \quad (6.29)$$

for the shear area,

where $\rho = \left(\frac{2V_{Ed}}{V_{pl,Rd}} - 1 \right)^2$ and $V_{pl,Rd}$ is obtained from 6.2.6(2).

NOTE See also 6.2.10(3).

(4) When torsion is present ρ should be obtained from $\rho = \left(\frac{2V_{Ed}}{V_{pl,T,Rd}} - 1 \right)^2$, see 6.2.7, but should be taken

as 0 for $V_{Ed} \leq 0,5V_{pl,T,Rd}$.

(5) The reduced design plastic resistance moment allowing for the shear force may alternatively be obtained for I-cross-sections with equal flanges and bending about the major axis as follows:

$$M_{y,V,Rd} = \frac{\left[W_{pl,y} - \frac{\rho A_w^2}{4 t_w} \right] f_y}{\gamma_{M0}} \quad \text{but } M_{y,V,Rd} \leq M_{y,c,Rd} \quad (6.30)$$

where $M_{y,c,Rd}$ is obtained from 6.2.5(2)

and $A_w = h_w t_w$

(6) For the interaction of bending, shear and transverse loads see section 7 of EN 1993-1-5.

6.2.9 Bending and axial force

6.2.9.1 Class 1 and 2 cross-sections

(1) Where an axial force is present, allowance should be made for its effect on the plastic moment resistance.

[AC1] (2)P For class 1 and 2 cross sections, the following criterion shall be satisfied: **[AC1]**

$$M_{Ed} \leq M_{N,Rd} \quad (6.31)$$

where $M_{N,Rd}$ is the design plastic moment resistance reduced due to the axial force N_{Ed} .

(3) For a rectangular solid section without fastener holes $M_{N,Rd}$ should be taken as:

$$M_{N,Rd} = M_{pl,Rd} \left[1 - \left(N_{Ed} / N_{pl,Rd} \right)^2 \right] \quad (6.32)$$

(4) For doubly symmetrical I- and H-sections or other flanges sections, allowance need not be made for the effect of the axial force on the plastic resistance moment about the y-y axis when both the following criteria are satisfied:

$$N_{Ed} \leq 0,25 N_{pl,Rd} \quad \text{and} \quad (6.33)$$

$$N_{Ed} \leq \frac{0,5 h_w t_w f_y}{\gamma_{M0}} \quad (6.34)$$

For doubly symmetrical I- and H-sections, allowance need not be made for the effect of the axial force on the plastic resistance moment about the z-z axis when:

$$N_{Ed} \leq \frac{h_w t_w f_y}{\gamma_{M0}} \quad (6.35)$$

(5) For cross-sections where fastener holes are not to be accounted for, the following approximations may be used for standard rolled I or H sections and for welded I or H sections with equal flanges:

$$M_{N,y,Rd} = M_{pl,y,Rd} (1-n)/(1-0,5a) \quad \text{but } M_{N,y,Rd} \leq M_{pl,y,Rd} \quad (6.36)$$

$$\text{for } n \leq a: \quad M_{N,z,Rd} = M_{pl,z,Rd} \quad (6.37)$$

$$\text{for } n > a: \quad M_{N,z,Rd} = M_{pl,z,Rd} \left[1 - \left(\frac{n-a}{1-a} \right)^2 \right] \quad (6.38)$$

where $n = N_{Ed} / N_{pl,Rd}$

$a = (A-2bt_f)/A$ but $a \leq 0,5$

For cross-sections where fastener holes are not to be accounted for, the following approximations may be used for rectangular structural hollow sections of uniform thickness and for welded box sections with equal flanges and equal webs:

$$M_{N,y,Rd} = M_{pl,y,Rd} (1 - n)/(1 - 0,5a_w) \quad \text{but } M_{N,y,Rd} \leq M_{pl,y,Rd} \quad (6.39)$$

$$M_{N,z,Rd} = M_{pl,z,Rd} (1 - n)/(1 - 0,5a_f) \quad \text{but } M_{N,z,Rd} \leq M_{pl,z,Rd} \quad (6.40)$$

where $a_w = (A - 2bt)/A$ but $a_w \leq 0,5$ for hollow sections
 $a_w = (A - 2bt_f)/A$ but $a_w \leq 0,5$ for welded box sections
 $a_f = (A - 2ht)/A$ but $a_f \leq 0,5$ for hollow sections
 $a_f = (A - 2ht_w)/A$ but $a_f \leq 0,5$ for welded box sections

(6) For bi-axial bending the following criterion may be used:

$$\left[\frac{M_{y,Ed}}{M_{N,y,Rd}} \right]^\alpha + \left[\frac{M_{z,Ed}}{M_{N,z,Rd}} \right]^\beta \leq 1 \quad (6.41)$$

in which α and β are constants, which may conservatively be taken as unity, otherwise as follows:

– I and H sections:

$$\alpha = 2 ; \beta = 5n \quad \text{but } \beta \geq 1$$

– circular hollow sections:

$$\alpha = 2 ; \beta = 2$$

– rectangular hollow sections:

$$\alpha = \beta = \frac{1,66}{1 - 1,13n^2} \quad \text{but } \alpha = \beta \leq 6$$

where $n = N_{Ed} / N_{pl,Rd}$.

6.2.9.2 Class 3 cross-sections

AC1 (1)P In the absence of shear force, for Class 3 cross-sections the maximum longitudinal stress shall satisfy the criterion: **AC1**

$$\sigma_{x,Ed} \leq \frac{f_y}{\gamma_{M0}} \quad (6.42)$$

where $\sigma_{x,Ed}$ is the design value of the local longitudinal stress due to moment and axial force taking account of fastener holes where relevant, see 6.2.3, 6.2.4 and 6.2.5

6.2.9.3 Class 4 cross-sections

AC1 (1)P In the absence of shear force, for Class 4 cross-sections the maximum longitudinal stress $\sigma_{x,Ed}$ calculated using the effective cross sections (see 5.5.2(2)) shall satisfy the criterion: **AC1**

$$\sigma_{x,Ed} \leq \frac{f_y}{\gamma_{M0}} \quad (6.43)$$

where $\sigma_{x,Ed}$ is the design value of the local longitudinal stress due to moment and axial force taking account of fastener holes where relevant, see 6.2.3, 6.2.4 and 6.2.5

(2) The following criterion should be met:

$$\frac{N_{Ed}}{A_{eff} f_y / \gamma_{M0}} + \frac{M_{y,Ed} + N_{Ed} e_{Ny}}{W_{eff,y,min} f_y / \gamma_{M0}} + \frac{M_{z,Ed} + N_{Ed} e_{Nz}}{W_{eff,z,min} f_y / \gamma_{M0}} \leq 1 \quad (6.44)$$

where A_{eff} is the effective area of the cross-section when subjected to uniform compression

$W_{eff,min}$ is the effective section modulus (corresponding to the fibre with the maximum elastic stress) of the cross-section when subjected only to moment about the relevant axis

e_N is the shift of the relevant centroidal axis when the cross-section is subjected to compression only, see 6.2.2.5(4)

NOTE The signs of N_{Ed} , $M_{y,Ed}$, $M_{z,Ed}$ and $\Delta M_i = N_{Ed} e_{Ni}$ depend on the combination of the respective direct stresses.

6.2.10 Bending, shear and axial force

(1) Where shear and axial force are present, allowance should be made for the effect of both shear force and axial force on the resistance moment.

(2) Provided that the design value of the shear force V_{Ed} does not exceed 50% of the design plastic shear resistance $V_{pl,Rd}$ no reduction of the resistances defined for bending and axial force in 6.2.9 need be made, except where shear buckling reduces the section resistance, see EN 1993-1-5.

(3) Where V_{Ed} exceeds 50% of $V_{pl,Rd}$ the design resistance of the cross-section to combinations of moment and axial force should be calculated using a reduced yield strength

$$(1-\rho)f_y \quad (6.45)$$

for the shear area

where $\rho = (2V_{Ed} / V_{pl,Rd} - 1)^2$ and $V_{pl,Rd}$ is obtained from 6.2.6(2).

NOTE Instead of reducing the yield strength also the plate thickness of the relevant part of the cross section may be reduced.

6.3 Buckling resistance of members

6.3.1 Uniform members in compression

6.3.1.1 Buckling resistance

(1) A compression member should be verified against buckling as follows:

$$\frac{N_{Ed}}{N_{b,Rd}} \leq 1,0 \quad (6.46)$$

where N_{Ed} is the design value of the compression force;

$N_{b,Rd}$ is the design buckling resistance of the compression member.

(2) For members with non-symmetric Class 4 sections allowance should be made for the additional moment ΔM_{Ed} due to the eccentricity of the centroidal axis of the effective section, see also 6.2.2.5(4), and the interaction should be carried out to 6.3.4 or 6.3.3.

(3) The design buckling resistance of a compression member should be taken as:

$$N_{b,Rd} = \frac{\chi A f_y}{\gamma_{M1}} \quad \text{for Class 1, 2 and 3 cross-sections} \quad (6.47)$$

$$N_{b,Rd} = \frac{\chi A_{eff} f_y}{\gamma_{M1}} \quad \text{for Class 4 cross-sections} \quad (6.48)$$

where χ is the reduction factor for the relevant buckling mode.

NOTE For determining the buckling resistance of members with tapered sections along the member or for non-uniform distribution of the compression force second order analysis according to 5.3.4(2) may be performed. For out-of-plane buckling see also 6.3.4.

(4) In determining A and A_{eff} holes for fasteners at the column ends need not to be taken into account.

6.3.1.2 Buckling curves

(1) For axial compression in members the value of χ for the appropriate non-dimensional slenderness $\bar{\lambda}$ should be determined from the relevant buckling curve according to:

$$\chi = \frac{1}{\Phi + \sqrt{\Phi^2 - \bar{\lambda}^2}} \quad \text{but } \chi \leq 1,0 \quad (6.49)$$

where $\Phi = 0,5 \left[1 + \alpha(\bar{\lambda} - 0,2) + \bar{\lambda}^2 \right]$

$$\bar{\lambda} = \sqrt{\frac{A f_y}{N_{cr}}} \quad \text{for Class 1, 2 and 3 cross-sections}$$

$$\bar{\lambda} = \sqrt{\frac{A_{eff} f_y}{N_{cr}}} \quad \text{for Class 4 cross-sections}$$

α is an imperfection factor

N_{cr} is the elastic critical force for the relevant buckling mode based on the gross cross sectional properties.

(2) The imperfection factor α corresponding to the appropriate buckling curve should be obtained from Table 6.1 and Table 6.2.

Table 6.1: Imperfection factors for buckling curves

Buckling curve	a ₀	a	b	c	d
Imperfection factor α	0,13	0,21	0,34	0,49	0,76

(3) Values of the reduction factor χ for the appropriate non-dimensional slenderness $\bar{\lambda}$ may be obtained from Figure 6.4.

(4) For slenderness $\bar{\lambda} \leq 0,2$ or for $\frac{N_{Ed}}{N_{cr}} \leq 0,04$ the buckling effects may be ignored and only cross sectional checks apply.

Table 6.2: Selection of buckling curve for a cross-section

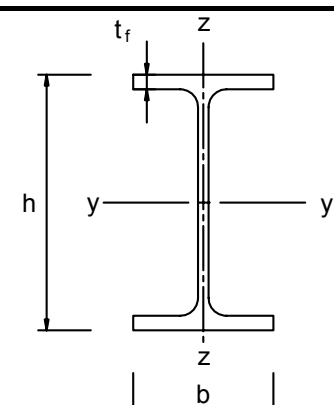
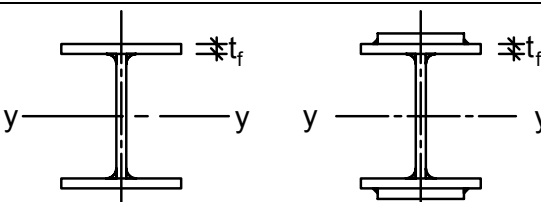
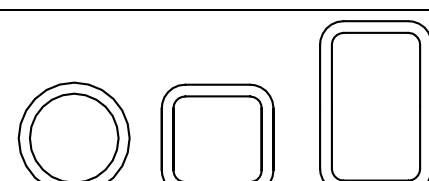
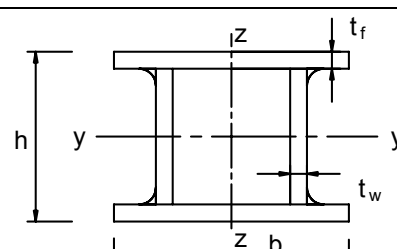
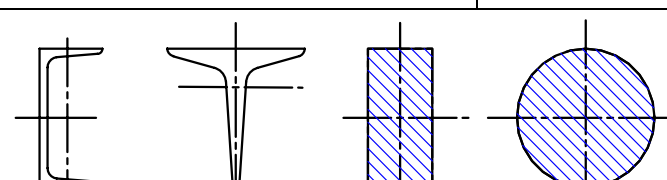
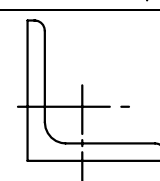
Cross section	Limits	Buckling about axis	Buckling curve		
			S 235 S 275 S 355 S 420	S 460	
Rolled sections 	$h/b > 1,2$	y - y z - z	$t_f \leq 40 \text{ mm}$	a b	a ₀ a ₀
			$40 \text{ mm} < t_f \leq 100$	b c	a a
	$h/b \leq 1,2$	y - y z - z	$t_f \leq 100 \text{ mm}$	b c	a a
			$t_f > 100 \text{ mm}$	d d	c c
Welded I-sections 	$t_f \leq 40 \text{ mm}$	y - y z - z	b c	b c	
	$t_f > 40 \text{ mm}$	y - y z - z	c d	c d	
Hollow sections 	hot finished	any	a	a ₀	
	cold formed	any	c	c	
Welded box sections 	generally (except as below)	any	b	b	
	thick welds: $a > 0,5t_f$ $b/t_f < 30$ $h/t_w < 30$	any	c	c	
U-, T- and solid sections 		any	c	c	
L-sections 		any	b	b	

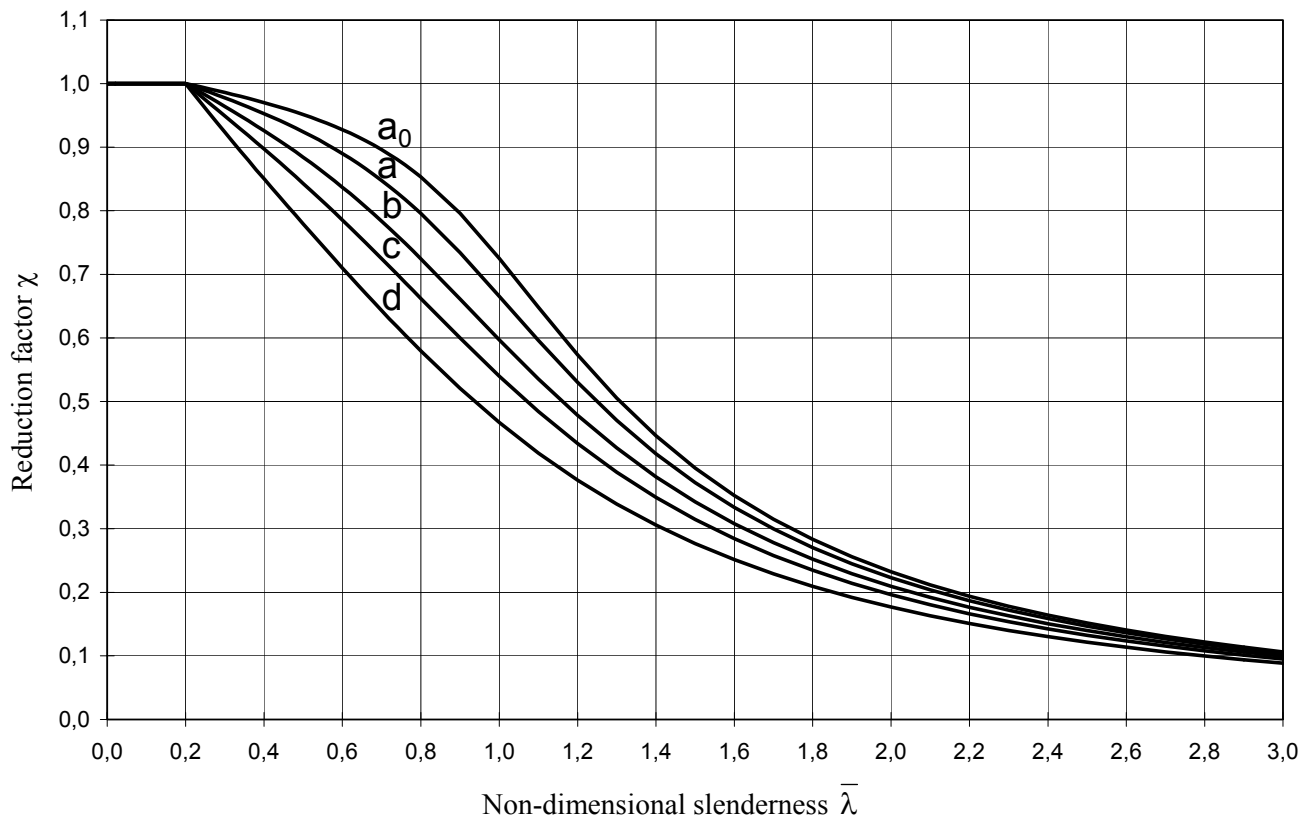

Figure 6.4: Buckling curves

6.3.1.3 Slenderness for flexural buckling

(1) The non-dimensional slenderness $\bar{\lambda}$ is given by:

$$\bar{\lambda} = \sqrt{\frac{Af_y}{N_{cr}}} = \frac{L_{cr}}{i} \frac{1}{\lambda_1} \quad \text{for Class 1, 2 and 3 cross-sections} \quad (6.50)$$

$$\bar{\lambda} = \sqrt{\frac{A_{eff}f_y}{N_{cr}}} = \frac{L_{cr}}{i} \sqrt{\frac{A_{eff}}{A}} \frac{1}{\lambda_1} \quad \text{for Class 4 cross-sections} \quad (6.51)$$

where L_{cr} is the buckling length in the buckling plane considered

i is the radius of gyration about the relevant axis, determined using the properties of the gross cross-section

$$\lambda_1 = \pi \sqrt{\frac{E}{f_y}} = 93,9\varepsilon$$

$$\varepsilon = \sqrt{\frac{235}{f_y}} \quad (f_y \text{ in N/mm}^2)$$

NOTE B For elastic buckling of components of building structures see Annex BB.

(2) For flexural buckling the appropriate buckling curve should be determined from Table 6.2.

6.3.1.4 Slenderness for torsional and torsional-flexural buckling

(1) For members with open cross-sections account should be taken of the possibility that the resistance of the member to either torsional or torsional-flexural buckling could be less than its resistance to flexural buckling.

(2) The non-dimensional slenderness $\bar{\lambda}_T$ for torsional or torsional-flexural buckling should be taken as:

$$\bar{\lambda}_T = \sqrt{\frac{Af_y}{N_{cr}}} \quad \text{for Class 1, 2 and 3 cross-sections} \quad (6.52)$$

$$\bar{\lambda}_T = \sqrt{\frac{A_{eff}f_y}{N_{cr}}} \quad \text{for Class 4 cross-sections} \quad (6.53)$$

where $N_{cr} = N_{cr,TF}$ but $N_{cr} < N_{cr,T}$

$N_{cr,TF}$ is the elastic torsional-flexural buckling force;

$N_{cr,T}$ is the elastic torsional buckling force.

(3) For torsional or torsional-flexural buckling the appropriate buckling curve may be determined from Table 6.2 considering the one related to the z-axis.

6.3.2 Uniform members in bending

6.3.2.1 Buckling resistance

(1) A laterally unrestrained member subject to major axis bending should be verified against lateral-torsional buckling as follows:

$$\frac{M_{Ed}}{M_{b,Rd}} \leq 1,0 \quad (6.54)$$

where M_{Ed} is the design value of the moment

$M_{b,Rd}$ is the design buckling resistance moment.

(2) Beams with sufficient restraint to the compression flange are not susceptible to lateral-torsional buckling. In addition, beams with certain types of cross-sections, such as square or circular hollow sections, fabricated circular tubes or square box sections are not susceptible to lateral-torsional buckling.

(3) The design buckling resistance moment of a laterally unrestrained beam should be taken as:

$$M_{b,Rd} = \chi_{LT} W_y \frac{f_y}{\gamma_{M1}} \quad (6.55)$$

where W_y is the appropriate section modulus as follows:

– $W_y = W_{pl,y}$ for Class 1 or 2 cross-sections

– $W_y = W_{el,y}$ for Class 3 cross-sections

– $W_y = W_{eff,y}$ for Class 4 cross-sections

χ_{LT} is the reduction factor for lateral-torsional buckling.

NOTE 1 For determining the buckling resistance of beams with tapered sections second order analysis according to 5.3.4(3) may be performed. For out-of-plane buckling see also 6.3.4.

NOTE 2B For buckling of components of building structures see also Annex BB.

(4) In determining W_y holes for fasteners at the beam end need not to be taken into account.

6.3.2.2 Lateral torsional buckling curves – General case

(1) Unless otherwise specified, see 6.3.2.3, for bending members of constant cross-section, the value of χ_{LT} for the appropriate non-dimensional slenderness $\bar{\lambda}_{LT}$, should be determined from:

$$\chi_{LT} = \frac{1}{\Phi_{LT} + \sqrt{\Phi_{LT}^2 - \bar{\lambda}_{LT}^2}} \text{ but } \chi_{LT} \leq 1,0 \quad (6.56)$$

where $\Phi_{LT} = 0,5 \left[1 + \alpha_{LT} (\bar{\lambda}_{LT} - 0,2) + \bar{\lambda}_{LT}^2 \right]$

α_{LT} is an imperfection factor

$$\bar{\lambda}_{LT} = \sqrt{\frac{W_y f_y}{M_{cr}}}$$

M_{cr} is the elastic critical moment for lateral-torsional buckling

(2) M_{cr} is based on gross cross sectional properties and takes into account the loading conditions, the real moment distribution and the lateral restraints.

NOTE The imperfection factor α_{LT} corresponding to the appropriate buckling curve may be obtained from the National Annex. The recommended values α_{LT} are given in Table 6.3.

Table 6.3: Recommended values for imperfection factors for lateral torsional buckling curves

Buckling curve	a	b	c	d
Imperfection factor α_{LT}	0,21	0,34	0,49	0,76

The recommendations for buckling curves are given in Table 6.4.

Table 6.4: Recommended values for lateral torsional buckling curves for cross-sections using equation (6.56)

Cross-section	Limits	Buckling curve
Rolled I-sections	$h/b \leq 2$	a
	$h/b > 2$	b
Welded I-sections	$h/b \leq 2$	c
	$h/b > 2$	d
Other cross-sections	-	d

(3) Values of the reduction factor χ_{LT} for the appropriate non-dimensional slenderness $\bar{\lambda}_{LT}$ may be obtained from Figure 6.4.

(4) For slendernesses $\bar{\lambda}_{LT} \leq \bar{\lambda}_{LT,0}$ (see 6.3.2.3) or for $\frac{M_{Ed}}{M_{cr}} \leq \bar{\lambda}_{LT,0}^2$ (see 6.3.2.3) lateral torsional buckling effects may be ignored and only cross sectional checks apply.

6.3.2.3 Lateral torsional buckling curves for rolled sections or equivalent welded sections

(1) For rolled or equivalent welded sections in bending the values of χ_{LT} for the appropriate non-dimensional slenderness may be determined from

$$\chi_{LT} = \frac{1}{\Phi_{LT} + \sqrt{\Phi_{LT}^2 - \beta \bar{\lambda}_{LT}^2}} \text{ but } \begin{cases} \chi_{LT} \leq 1,0 \\ \chi_{LT} \leq \frac{1}{\bar{\lambda}_{LT}^2} \end{cases} \quad (6.57)$$

$$\Phi_{LT} = 0,5 \left[1 + \alpha_{LT} (\bar{\lambda}_{LT} - \bar{\lambda}_{LT,0}) + \beta \bar{\lambda}_{LT}^2 \right]$$

NOTE The parameters $\bar{\lambda}_{LT,0}$ and β and any limitation of validity concerning the beam depth or h/b ratio may be given in the National Annex. The following values are recommended for rolled sections or equivalent welded sections:

$$\bar{\lambda}_{LT,0} = 0,4 \text{ (maximum value)}$$

$$\beta = 0,75 \text{ (minimum value)}$$

The recommendations for buckling curves are given in Table 6.5.

Table 6.5: Recommendation for the selection of lateral torsional buckling curve for cross sections using equation (6.57)

Cross-section	Limits	Buckling curve
Rolled I-sections	$h/b \leq 2$	b
	$h/b > 2$	c
Welded I-sections	$h/b \leq 2$	c
	$h/b > 2$	d

(2) For taking into account the moment distribution between the lateral restraints of members the reduction factor χ_{LT} may be modified as follows:







$$\chi_{LT,mod} = \frac{\chi_{LT}}{f} \text{ but } \chi_{LT,mod} \leq 1 \quad (6.58)$$

NOTE The values f may be defined in the National Annex. The following minimum values are recommended:

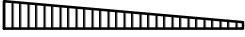
$$f = 1 - 0,5(1 - k_c)[1 - 2,0(\bar{\lambda}_{LT} - 0,8)^2] \text{ but } f \leq 1,0$$

k_c is a correction factor according to Table 6.6

Table 6.6: Correction factors k_c

Moment distribution	k_c
 $\psi = 1$	1,0
 $-1 \leq \psi \leq 1$	$\frac{1}{1,33 - 0,33\psi}$
	0,94
	0,90
	0,91
	0,86
	0,77
	0,82

6.3.2.4 Simplified assessment methods for beams with restraints in buildings

(1)B Members with discrete lateral restraint to the compression flange are not susceptible to lateral-torsional buckling if the length L_c between restraints or the resulting slenderness $\bar{\lambda}_f$ of the equivalent compression flange satisfies:

$$\bar{\lambda}_f = \frac{k_c L_c}{i_{f,z} \lambda_1} \leq \bar{\lambda}_{c0} \frac{M_{c,Rd}}{M_{y,Ed}} \quad (6.59)$$

where $M_{y,Ed}$ is the maximum design value of the bending moment within the restraint spacing

$$M_{c,Rd} = W_y \frac{f_y}{\gamma_{M1}}$$

W_y is the appropriate section modulus corresponding to the compression flange

k_c is a slenderness correction factor for moment distribution between restraints, see Table 6.6

$i_{f,z}$ is the radius of gyration of the equivalent compression flange composed of the compression flange plus 1/3 of the compressed part of the web area, about the minor axis of the section

$\bar{\lambda}_{c0}$ is a slenderness limit of the equivalent compression flange defined above

$$\lambda_1 = \pi \sqrt{\frac{E}{f_y}} = 93,9\varepsilon$$

$$\varepsilon = \sqrt{\frac{235}{f_y}} \quad (f_y \text{ in N/mm}^2)$$

NOTE 1B For Class 4 cross-sections $i_{f,z}$ may be taken as

$$i_{f,z} = \sqrt{\frac{I_{\text{eff},f}}{A_{\text{eff},f} + \frac{1}{3}A_{\text{eff},w,c}}}$$

where $I_{\text{eff},f}$ is the effective second moment of area of the compression flange about the minor axis of the section

$A_{\text{eff},f}$ is the effective area of the compression flange

$A_{\text{eff},w,c}$ is the effective areas of the compressed part of the web

NOTE 2B The slenderness limit $\bar{\lambda}_{c0}$ may be given in the National Annex. A limit value $\bar{\lambda}_{c0} = \bar{\lambda}_{LT,0} + 0,1$ is recommended, see 6.3.2.3.

(2)B If the slenderness of the compression flange $\bar{\lambda}_f$ exceeds the limit given in (1)B, the design buckling resistance moment may be taken as:

$$M_{b,Rd} = k_{f\ell} \chi M_{c,Rd} \quad \text{but} \quad M_{b,Rd} \leq M_{c,Rd} \quad (6.60)$$

where χ is the reduction factor of the equivalent compression flange determined with $\bar{\lambda}_f$

$k_{f\ell}$ is the modification factor accounting for the conservatism of the equivalent compression flange method

NOTE B The modification factor may be given in the National Annex. A value $k_{f\ell} = 1,10$ is recommended.

(3)B The buckling curves to be used in (2)B should be taken as follows:

curve d for welded sections provided that: $\frac{h}{t_f} \leq 44\epsilon$

curve c for all other sections

where h is the overall depth of the cross-section

t_f is the thickness of the compression flange

NOTE B For lateral torsional buckling of components of building structures with restraints see also Annex BB.3.

6.3.3 Uniform members in bending and axial compression

(1) Unless second order analysis is carried out using the imperfections as given in 5.3.2, the stability of uniform members with double symmetric cross sections for sections not susceptible to distortional deformations should be checked as given in the following clauses, where a distinction is made for:

- members that are not susceptible to torsional deformations, e.g. circular hollow sections or sections restraint from torsion
- members that are susceptible to torsional deformations, e.g. members with open cross-sections and not restraint from torsion.

(2) In addition, the resistance of the cross-sections at each end of the member should satisfy the requirements given in 6.2.

NOTE 1 The interaction formulae are based on the modelling of simply supported single span members with end fork conditions and with or without continuous lateral restraints, which are subjected to compression forces, end moments and/or transverse loads.

NOTE 2 In case the conditions of application expressed in (1) and (2) are not fulfilled, see 6.3.4.

(3) For members of structural systems the resistance check may be carried out on the basis of the individual single span members regarded as cut out of the system. Second order effects of the sway system (P-Δ-effects) have to be taken into account, either by the end moments of the member or by means of appropriate buckling lengths respectively, see 5.2.2(3)c) and 5.2.2(8).

(4) Members which are subjected to combined bending and axial compression should satisfy:

$$\frac{N_{Ed}}{\chi_y N_{Rk}} + k_{yy} \frac{M_{y,Ed} + \Delta M_{y,Ed}}{\chi_{LT} \frac{M_{y,Rk}}{\gamma_{M1}}} + k_{yz} \frac{M_{z,Ed} + \Delta M_{z,Ed}}{\frac{M_{z,Rk}}{\gamma_{M1}}} \leq 1 \quad (6.61)$$

$$\frac{N_{Ed}}{\chi_z N_{Rk}} + k_{zy} \frac{M_{y,Ed} + \Delta M_{y,Ed}}{\chi_{LT} \frac{M_{y,Rk}}{\gamma_{M1}}} + k_{zz} \frac{M_{z,Ed} + \Delta M_{z,Ed}}{\frac{M_{z,Rk}}{\gamma_{M1}}} \leq 1 \quad (6.62)$$

where N_{Ed} , $M_{y,Ed}$ and $M_{z,Ed}$ are the design values of the compression force and the maximum moments about the y-y and z-z axis along the member, respectively

$\Delta M_{y,Ed}$, $\Delta M_{z,Ed}$ are the moments due to the shift of the centroidal axis according to 6.2.9.3 for class 4 sections, see Table 6.7,

χ_y and χ_z are the reduction factors due to flexural buckling from 6.3.1

χ_{LT} is the reduction factor due to lateral torsional buckling from 6.3.2

k_{yy} , k_{yz} , k_{zy} , k_{zz} are the interaction factors

Table 6.7: Values for $N_{Rk} = f_y A_i$, $M_{i,Rk} = f_y W_i$ and $\Delta M_{i,Ed}$

Class	1	2	3	4
A_i	A	A	A	A_{eff}
W_y	$W_{pl,y}$	$W_{pl,y}$	$W_{el,y}$	$W_{eff,y}$
W_z	$W_{pl,z}$	$W_{pl,z}$	$W_{el,z}$	$W_{eff,z}$
$\Delta M_{y,Ed}$	0	0	0	$e_{N,y} N_{Ed}$
$\Delta M_{z,Ed}$	0	0	0	$e_{N,z} N_{Ed}$

NOTE For members not susceptible to torsional deformation χ_{LT} would be $\chi_{LT} = 1,0$.

(5) The interaction factors k_{yy} , k_{yz} , k_{zy} , k_{zz} depend on the method which is chosen.

NOTE 1 The interaction factors k_{yy} , k_{yz} , k_{zy} and k_{zz} have been derived from two alternative approaches. Values of these factors may be obtained from Annex A (alternative method 1) or from Annex B (alternative method 2).

NOTE 2 The National Annex may give a choice from alternative method 1 or alternative method 2.

NOTE 3 For simplicity verifications may be performed in the elastic range only.

6.3.4 General method for lateral and lateral torsional buckling of structural components

(1) The following method may be used where the methods given in 6.3.1, 6.3.2 and 6.3.3 do not apply. It allows the verification of the resistance to lateral and lateral torsional buckling for structural components such as

- single members, built-up or not, uniform or not, with complex support conditions or not, or
- plane frames or subframes composed of such members,

which are subject to compression and/or mono-axial bending in the plane, but which do not contain rotative plastic hinges.

NOTE The National Annex may specify the field and limits of application of this method.

- (2) Overall resistance to out-of-plane buckling for any structural component conforming to the scope in (1) can be verified by ensuring that:

$$\frac{\chi_{op} \alpha_{ult,k}}{\gamma_{M1}} \geq 1,0 \quad (6.63)$$

where $\alpha_{ult,k}$ is the minimum load amplifier of the design loads to reach the characteristic resistance of the most critical cross section of the structural component considering its in plane behaviour without taking lateral or lateral torsional buckling into account however accounting for all effects due to in plane geometrical deformation and imperfections, global and local, where relevant;

χ_{op} is the reduction factor for the non-dimensional slenderness $\bar{\lambda}_{op}$, see (3), to take account of lateral and lateral torsional buckling.

- (3) The global non dimensional slenderness $\bar{\lambda}_{op}$ for the structural component should be determined from

$$\bar{\lambda}_{op} = \sqrt{\frac{\alpha_{ult,k}}{\alpha_{cr,op}}} \quad (6.64)$$

where $\alpha_{ult,k}$ is defined in (2)

$\alpha_{cr,op}$ is the minimum amplifier for the in plane design loads to reach the elastic critical resistance of the structural component with regards to lateral or lateral torsional buckling without accounting for in plane flexural buckling

NOTE In determining $\alpha_{cr,op}$ and $\alpha_{ult,k}$ Finite Element analysis may be used.

- (4) The reduction factor χ_{op} may be determined from either of the following methods:

a) the minimum value of

χ for lateral buckling according to 6.3.1

χ_{LT} for lateral torsional buckling according to 6.3.2

each calculated for the global non dimensional slenderness $\bar{\lambda}_{op}$.

NOTE For example where $\alpha_{ult,k}$ is determined by the cross section check $\frac{1}{\alpha_{ult,k}} = \frac{N_{Ed}}{N_{Rk}} + \frac{M_{y,Ed}}{M_{y,Rk}}$ this method leads to:

$$\frac{N_{Ed}}{N_{Rk}/\gamma_{M1}} + \frac{M_{y,Ed}}{M_{y,Rk}/\gamma_{M1}} \leq \chi_{op} \quad (6.65)$$

b) a value interpolated between the values χ and χ_{LT} as determined in a) by using the formula for $\alpha_{ult,k}$ corresponding to the critical cross section

NOTE For example where $\alpha_{ult,k}$ is determined by the cross section check $\frac{1}{\alpha_{ult,k}} = \frac{N_{Ed}}{N_{Rk}} + \frac{M_{y,Ed}}{M_{y,Rk}}$ this method leads to:

$$\frac{N_{Ed}}{\chi N_{Rk}/\gamma_{M1}} + \frac{M_{y,Ed}}{\chi_{LT} M_{y,Rk}/\gamma_{M1}} \leq 1 \quad (6.66)$$

6.3.5 Lateral torsional buckling of members with plastic hinges

6.3.5.1 General

(1)B Structures may be designed with plastic analysis provided lateral torsional buckling in the frame is prevented by the following means:

- a) restraints at locations of “rotated” plastic hinges, see 6.3.5.2, and
- b) verification of stable length of segment between such restraints and other lateral restraints, see 6.3.5.3

(2)B Where under all ultimate limit state load combinations, the plastic hinge is “not-rotated” no restraints are necessary for such a plastic hinge.

6.3.5.2 Restraints at rotated plastic hinges

(1)B At each rotated plastic hinge location the cross section should have an effective lateral and torsional restraint with appropriate resistance to lateral forces and torsion induced by local plastic deformations of the member at this location.

(2)B Effective restraint should be provided

- for members carrying either moment or moment and axial force by lateral restraint to both flanges. This may be provided by lateral restraint to one flange and a stiff torsional restraint to the cross-section preventing the lateral displacement of the compression flange relative to the tension flange, see Figure 6.5.
- for members carrying either moment alone or moment and axial tension in which the compression flange is in contact with a floor slab, by lateral and torsional restraint to the compression flange (e.g. by connecting it to a slab, see Figure 6.6). For cross-sections that are more slender than rolled I and H sections the distortion of the cross section should be prevented at the plastic hinge location (e.g. by means of a web stiffener also connected to the compression flange with a stiff joint from the compression flange into the slab).

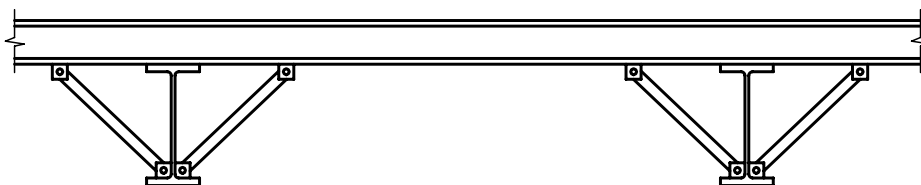
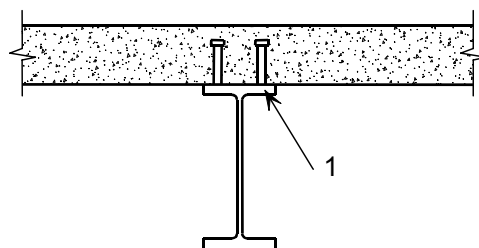

Figure 6.5: Typical stiff torsional restraint



1 compression flange

Figure 6.6: Typical lateral and torsional restraint by a slab to the compression flange

(3)B At each plastic hinge location, the connection (e.g. bolts) of the compression flange to the resisting element at that point (e.g. purlin), and any intermediate element (e.g. diagonal brace) should be designed to resist to a local force of at least 2,5% of $N_{f,Ed}$ (defined in 6.3.5.2(5)B) transmitted by the flange in its plane and perpendicular to the web plane, without any combination with other loads.

(4)B Where it is not practicable providing such a restraint directly at the hinge location, it should be provided within a distance of $h/2$ along the length of the member, where h is its overall depth at the plastic hinge location.

(5)B For the design of bracing systems, see 5.3.3, it should be verified by a check in addition to the check for imperfection according to 5.3.3 that the bracing system is able to resist the effects of local forces Q_m applied at each stabilized member at the plastic hinge locations, where;

$$Q_m = 1,5 \alpha_m \frac{N_{f,Ed}}{100} \quad (6.67)$$

where $N_{f,Ed}$ is the axial force in the compressed flange of the stabilized member at the plastic hinge location;

α_m is according to 5.3.3(1).

NOTE For combination with external loads see also 5.3.3(5).

6.3.5.3 Verification of stable length of segment

(1)B The lateral torsional buckling verification of segments between restraints may be performed by checking that the length between restraints is not greater than the stable length.

For uniform beam segments with I or H cross sections with $\frac{h}{t_f} \leq 40\varepsilon$ under linear moment and without significant axial compression the stable length may be taken from

$$\begin{aligned} L_{stable} &= 35 \varepsilon i_z && \text{for } 0,625 \leq \psi \leq 1 \\ L_{stable} &= (60 - 40\psi) \varepsilon i_z && \text{for } -1 \leq \psi \leq 0,625 \end{aligned} \quad (6.68)$$

where $\varepsilon = \sqrt{\frac{235}{f_y [\text{N/mm}^2]}}$

$$\psi = \frac{M_{Ed,min}}{M_{pl,Rd}} = \text{ratio of end moments in the segment}$$

NOTE B For the stable length of a segment see also Annex BB.3.

(2)B Where a rotated plastic hinge location occurs immediately adjacent to one end of a haunch, the tapered segment need not be treated as a segment adjacent to a plastic hinge location if the following criteria are satisfied:

- the restraint at the plastic hinge location should be within a distance $h/2$ along the length of the tapered segment, not the uniform segment;
- the compression flange of the haunch remains elastic throughout its length.

NOTE B For more information see Annex BB.3.

6.4 Uniform built-up compression members

6.4.1 General

(1) Uniform built-up compression members with hinged ends that are laterally supported should be designed with the following model, see Figure 6.7.

1. The member may be considered as a column with a bow imperfection $e_0 = \frac{L}{500}$
2. The elastic deformations of lacings or battening, see Figure 6.7, may be considered by a continuous (smeared) shear stiffness S_V of the column.

NOTE For other end conditions appropriate modifications may be performed.

(2) The model of a uniform built-up compression member applies when

1. the lacings or battening consist of equal modules with parallel chords
2. the minimum numbers of modules in a member is three.

NOTE This assumption allows the structure to be regular and smearing the discrete structure to a continuum.

(3) The design procedure is applicable to built-up members with lacings in two planes, see Figure 6.8.

(4) The chords may be solid members or may themselves be laced or battened in the perpendicular plane.

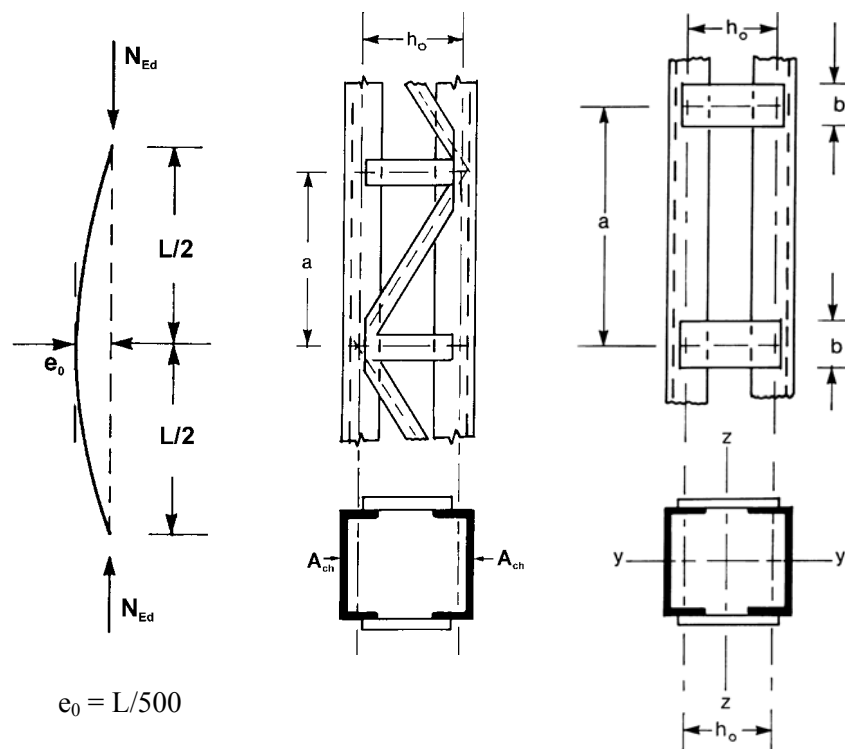

Figure 6.7: Uniform built-up columns with lacings and battening

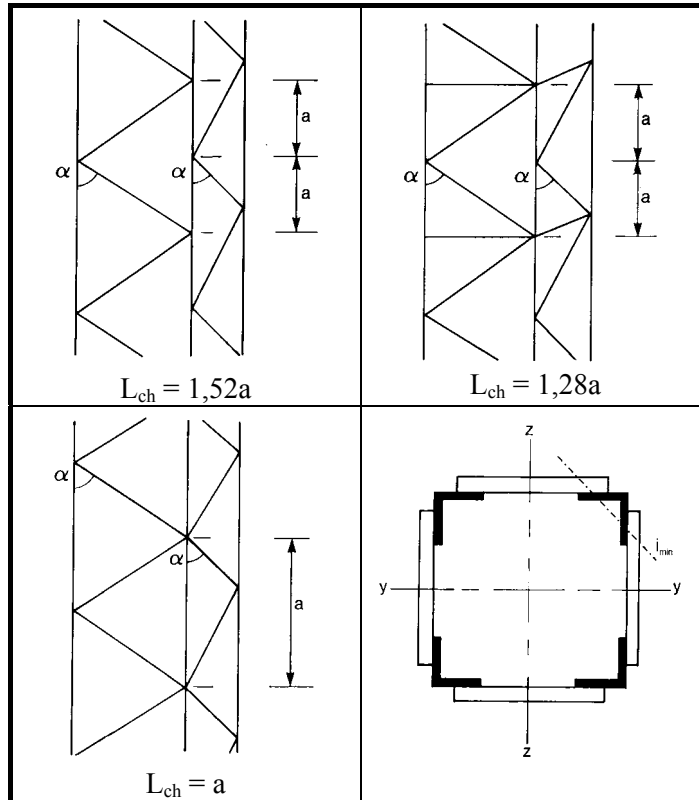

Figure 6.8: Lacings on four sides and buckling length L_{ch} of chords

- (5) Checks should be performed for chords using the design chord forces $N_{ch,Ed}$ from compression forces N_{Ed} and moments M_{Ed} at mid span of the built-up member.
- (6) For a member with two identical chords the design force $N_{ch,Ed}$ should be determined from:

$$N_{ch,Ed} = 0,5N_{Ed} + \frac{M_{Ed}h_0A_{ch}}{2I_{eff}} \quad (6.69)$$

where
$$M_{Ed} = \frac{N_{Ed}e_0 + M_{Ed}^I}{1 - \frac{N_{Ed}}{N_{cr}} - \frac{N_{Ed}}{S_v}}$$

$N_{cr} = \frac{\pi^2 EI_{eff}}{L^2}$ is the effective critical force of the built-up member

N_{Ed} is the design value of the compression force to the built-up member

M_{Ed} is the design value of the maximum moment in the middle of the built-up member considering second order effects

M_{Ed}^I is the design value of the maximum moment in the middle of the built-up member without second order effects

h_0 is the distance between the centroids of chords

A_{ch} is the cross-sectional area of one chord

I_{eff} is the effective second moment of area of the built-up member, see 6.4.2 and 6.4.3

S_v is the shear stiffness of the lacings or battened panel, see 6.4.2 and 6.4.3.

(7) The checks for the lacings of laced built-up members or for the frame moments and shear forces of the battened panels of battened built-up members should be performed for the end panel taking account of the shear force in the built-up member:

$$V_{Ed} = \pi \frac{M_{Ed}}{L} \tag{6.70}$$

6.4.2 Laced compression members

6.4.2.1 Resistance of components of laced compression members

(1) The chords and diagonal lacings subject to compression should be designed for buckling.

NOTE Secondary moments may be neglected.

(2) For chords the buckling verification should be performed as follows:

$$\frac{N_{ch,Ed}}{N_{b,Rd}} \leq 1,0 \tag{6.71}$$

where $N_{ch,Ed}$ is the design compression force in the chord at mid-length of the built-up member according to 6.4.1(6)

and $N_{b,Rd}$ is the design value of the buckling resistance of the chord taking the buckling length L_{ch} from Figure 6.8.

(3) The shear stiffness S_V of the lacings should be taken from Figure 6.9.

(4) The effective second order moment of area of laced built-up members may be taken as:

$$I_{eff} = 0,5h_0^2 A_{ch} \tag{6.72}$$

System			
S_V	$\frac{nEA_d ah_0^2}{2d^3}$	$\frac{nEA_d ah_0^2}{d^3}$	$\frac{nEA_d ah_0^2}{d^3 \left[1 + \frac{A_d h_0^3}{A_v d^3} \right]}$
<p>n is the number of planes of lacings A_d and A_v refer to the cross sectional area of the bracings</p>			

Figure 6.9: Shear stiffness of lacings of built-up members

6.4.2.2 Constructional details

(1) Single lacing systems in opposite faces of the built-up member with two parallel laced planes should be corresponding systems as shown in Figure 6.10(a), arranged so that one is the shadow of the other.

(2) When the single lacing systems on opposite faces of a built-up member with two parallel laced planes are mutually opposed in direction as shown in Figure 6.10(b), the resulting torsional effects in the member should be taken into account.

(3) Tie panels should be provided at the ends of lacing systems, at points where the lacing is interrupted and at joints with other members.

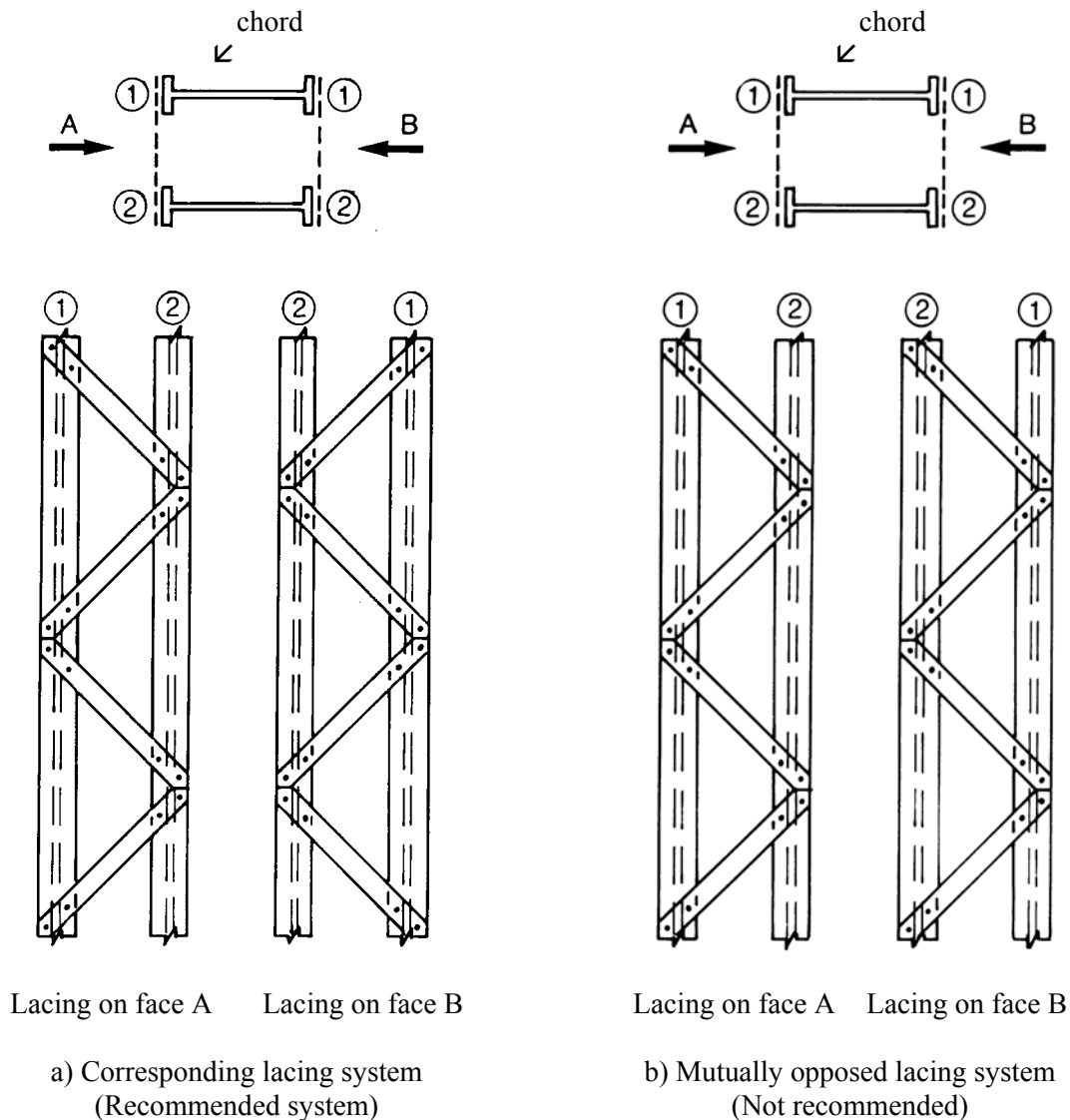

Figure 6.10: Single lacing system on opposite faces of a built-up member with two parallel laced planes

6.4.3 Battened compression members

6.4.3.1 Resistance of components of battened compression members

(1) The chords and the battens and their joints to the chords should be checked for the actual moments and forces in an end panel and at mid-span as indicated in Figure 6.11.

NOTE For simplicity the maximum chord forces $N_{ch,Ed}$ may be combined with the maximum shear force V_{Ed} .

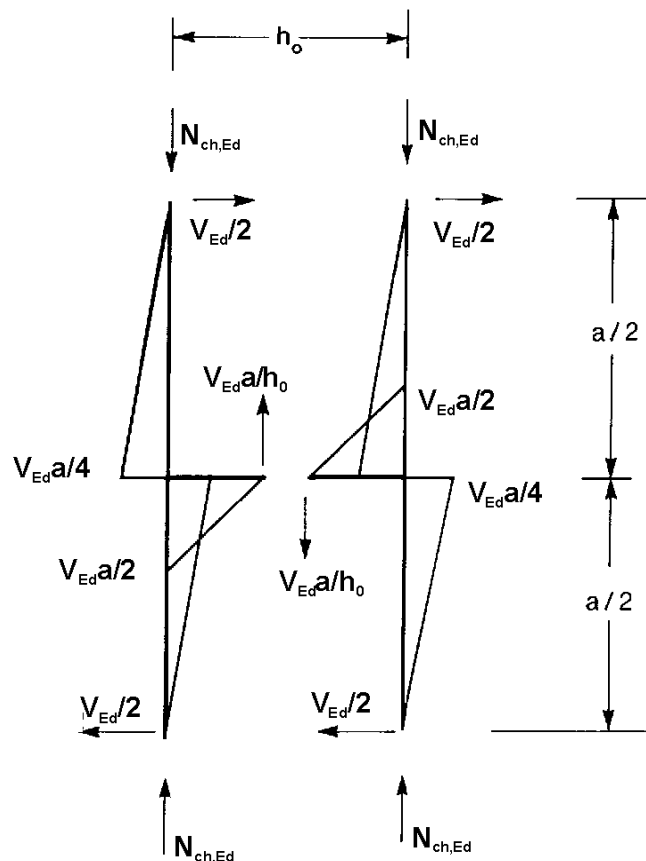

Figure 6.11: Moments and forces in an end panel of a battened built-up member

(2) The shear stiffness S_v should be taken as follows:

$$S_v = \frac{24EI_{ch}}{a^2 \left[1 + \frac{2I_{ch}}{nI_b} \frac{h_0}{a} \right]} \leq \frac{2\pi^2 EI_{ch}}{a^2} \tag{6.73}$$

(3) The effective second moments of area of battened built-up members may be taken as:

$$I_{eff} = 0,5h_0^2 A_{ch} + 2\mu I_{ch} \tag{6.74}$$

where I_{ch} = in plane second moment of area of one chord

I_b = in plane second moment of area of one batten

μ = efficiency factor from Table 6.8

n = number of planes of lacings

Table 6.8: Efficiency factor μ

Criterion	Efficiency factor μ
$\lambda \geq 150$	0
$75 < \lambda < 150$	$\mu = 2 - \frac{\lambda}{75}$
$\lambda \leq 75$	1,0

where $\lambda = \frac{L}{i_0}$; $i_0 = \sqrt{\frac{I_1}{2A_{ch}}}$; $I_1 = 0,5h_0^2 A_{ch} + 2I_{ch}$

6.4.3.2 Design details

- (1) Battens should be provided at each end of a member.
- (2) Where parallel planes of battens are provided, the battens in each plane should be arranged opposite each other.
- (3) Battens should also be provided at intermediate points where loads are applied or lateral restraint is supplied.

6.4.4 Closely spaced built-up members

(1) Built-up compression members with chords in contact or closely spaced and connected through packing plates, see Figure 6.12, or star batted angle members connected by pairs of battens in two perpendicular planes, see Figure 6.13 should be checked for buckling as a single integral member ignoring the effect of shear stiffness ($S_v = \infty$), when the conditions in Table 6.9 are met.

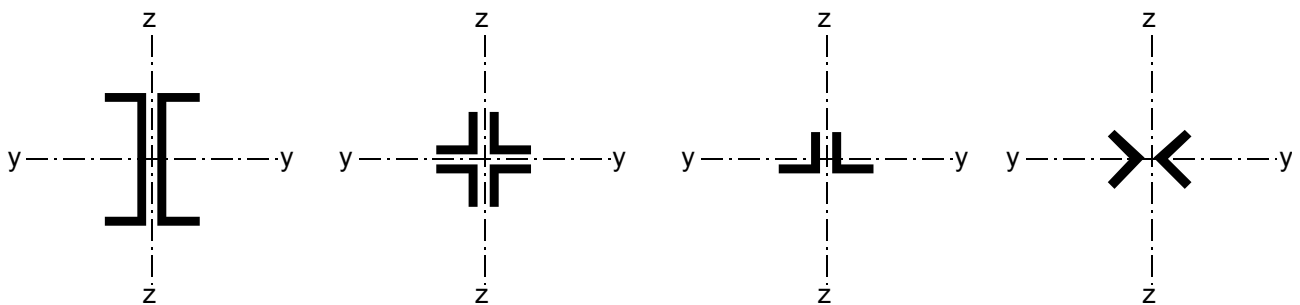

Figure 6.12: Closely spaced built-up members

Table 6.9: Maximum spacings for interconnections in closely spaced built-up or star batted angle members

Type of built-up member	Maximum spacing between interconnections *)
Members according to Figure 6.12 connected by bolts or welds	15 i_{min}
Members according to Figure 6.13 connected by pair of battens	70 i_{min}
*) centre-to-centre distance of interconnections i_{min} is the minimum radius of gyration of one chord or one angle	

- (2) The shear forces to be transmitted by the battens should be determined from 6.4.3.1(1).
- (3) In the case of unequal-leg angles, see Figure 6.13, buckling about the y-y axis may be verified with:

$$i_y = \frac{i_0}{1,15} \tag{6.75}$$

where i_0 is the minimum radius of gyration of the built-up member.

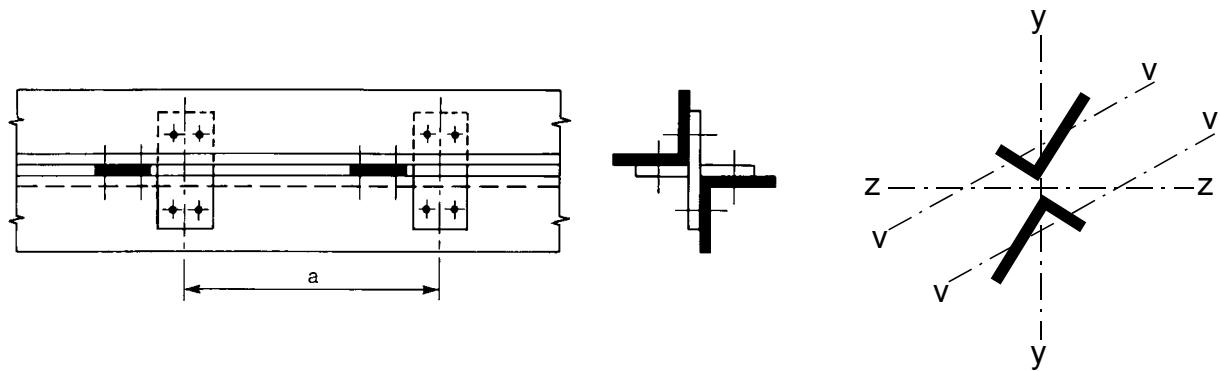

Figure 6.13: Star-battened angle members

7 Serviceability limit states

7.1 General

- (1) A steel structure should be designed and constructed such that all relevant serviceability criteria are satisfied.
- (2) The basic requirements for serviceability limit states are given in 3.4 of EN 1990.
- (3) Any serviceability limit state and the associated loading and analysis model should be specified for a project.
- (4) Where plastic global analysis is used for the ultimate limit state, plastic redistribution of forces and moments at the serviceability limit state may occur. If so, the effects should be considered.

7.2 Serviceability limit states for buildings

7.2.1 Vertical deflections

- (1)B With reference to EN 1990 – Annex A1.4 limits for vertical deflections according to Figure A1.1 should be specified for each project and agreed with the client.

NOTE B The National Annex may specify the limits.

7.2.2 Horizontal deflections

- (1)B With reference to EN 1990 – Annex A1.4 limits for horizontal deflections according to Figure A1.2 should be specified for each project and agreed with the client.

NOTE B The National Annex may specify the limits.

7.2.3 Dynamic effects

- (1)B With reference to EN 1990 – Annex A1.4.4 the vibrations of structures on which the public can walk should be limited to avoid significant discomfort to users, and limits should be specified for each project and agreed with the client.

NOTE B The National Annex may specify limits for vibration of floors.

Annex A [informative] – Method 1: Interaction factors k_{ij} for interaction formula in 6.3.3(4)

Table A.1: Interaction factors k_{ij} (6.3.3(4))

Interaction factors	Design assumptions	
	elastic cross-sectional properties class 3, class 4	plastic cross-sectional properties class 1, class 2
k_{yy}	$C_{my} C_{mLT} \frac{\mu_y}{1 - \frac{N_{Ed}}{N_{cr,y}}}$	$C_{my} C_{mLT} \frac{\mu_y}{1 - \frac{N_{Ed}}{N_{cr,y}}} \frac{1}{C_{yy}}$
k_{yz}	$C_{mz} \frac{\mu_y}{1 - \frac{N_{Ed}}{N_{cr,z}}}$	$C_{mz} \frac{\mu_y}{1 - \frac{N_{Ed}}{N_{cr,z}}} \frac{1}{C_{yz}} 0,6 \sqrt{\frac{w_z}{w_y}}$
k_{zy}	$C_{my} C_{mLT} \frac{\mu_z}{1 - \frac{N_{Ed}}{N_{cr,y}}}$	$C_{my} C_{mLT} \frac{\mu_z}{1 - \frac{N_{Ed}}{N_{cr,y}}} \frac{1}{C_{zy}} 0,6 \sqrt{\frac{w_y}{w_z}}$
k_{zz}	$C_{mz} \frac{\mu_z}{1 - \frac{N_{Ed}}{N_{cr,z}}}$	$C_{mz} \frac{\mu_z}{1 - \frac{N_{Ed}}{N_{cr,z}}} \frac{1}{C_{zz}}$
Auxiliary terms:		
$\mu_y = \frac{1 - \frac{N_{Ed}}{N_{cr,y}}}{1 - \chi_y \frac{N_{Ed}}{N_{cr,y}}}$ $\mu_z = \frac{1 - \frac{N_{Ed}}{N_{cr,z}}}{1 - \chi_z \frac{N_{Ed}}{N_{cr,z}}}$ $w_y = \frac{W_{pl,y}}{W_{el,y}} \leq 1,5$ $w_z = \frac{W_{pl,z}}{W_{el,z}} \leq 1,5$ $n_{pl} = \frac{N_{Ed}}{N_{Rk} / \gamma_{M1}}$ $C_{my} \text{ see Table A.2}$ $a_{LT} = 1 - \frac{I_T}{I_y} \geq 0$	$C_{yy} = 1 + (w_y - 1) \left[\left(2 - \frac{1,6}{w_y} C_{my}^2 \bar{\lambda}_{max} - \frac{1,6}{w_y} C_{my}^2 \bar{\lambda}_{max}^2 \right) n_{pl} - b_{LT} \right] \geq \frac{W_{el,y}}{W_{pl,y}}$ <p>with $b_{LT} = 0,5 a_{LT} \frac{\bar{\lambda}_0^{-2}}{\chi_{LT}} \frac{M_{y,Ed}}{M_{pl,y,Rd}} \frac{M_{z,Ed}}{M_{pl,z,Rd}}$</p> $C_{yz} = 1 + (w_z - 1) \left[\left(2 - 14 \frac{C_{mz}^2 \bar{\lambda}_{max}^2}{w_z^5} \right) n_{pl} - c_{LT} \right] \geq 0,6 \sqrt{\frac{w_z}{w_y}} \frac{W_{el,z}}{W_{pl,z}}$ <p>with $c_{LT} = 10 a_{LT} \frac{\bar{\lambda}_0^{-2}}{5 + \bar{\lambda}_z^4} \frac{M_{y,Ed}}{C_{my} \chi_{LT} M_{pl,y,Rd}}$</p> $C_{zy} = 1 + (w_y - 1) \left[\left(2 - 14 \frac{C_{my}^2 \bar{\lambda}_{max}^2}{w_y^5} \right) n_{pl} - d_{LT} \right] \geq 0,6 \sqrt{\frac{w_y}{w_z}} \frac{W_{el,y}}{W_{pl,y}}$ <p>with $d_{LT} = 2 a_{LT} \frac{\bar{\lambda}_0^{-2}}{0,1 + \bar{\lambda}_z^4} \frac{M_{y,Ed}}{C_{my} \chi_{LT} M_{pl,y,Rd}} \frac{M_{z,Ed}}{C_{mz} M_{pl,z,Rd}}$</p> $C_{zz} = 1 + (w_z - 1) \left[\left(2 - \frac{1,6}{w_z} C_{mz}^2 \bar{\lambda}_{max} - \frac{1,6}{w_z} C_{mz}^2 \bar{\lambda}_{max}^2 \right) n_{pl} - e_{LT} \right] \geq \frac{W_{el,z}}{W_{pl,z}}$ <p>with $e_{LT} = 1,7 a_{LT} \frac{\bar{\lambda}_0^{-2}}{0,1 + \bar{\lambda}_z^4} \frac{M_{y,Ed}}{C_{my} \chi_{LT} M_{pl,y,Rd}}$</p>	

Table A.1 (continued)

$$\bar{\lambda}_{\max} = \max \left\{ \begin{array}{l} \bar{\lambda}_y \\ \bar{\lambda}_z \end{array} \right.$$

$\bar{\lambda}_0$ = non-dimensional slenderness for lateral-torsional buckling due to uniform bending moment, i.e. $\psi_y = 1,0$ in Table A.2

$\bar{\lambda}_{LT}$ = non-dimensional slenderness for lateral-torsional buckling

$$\text{If } \bar{\lambda}_0 \leq 0,2\sqrt{C_1} \sqrt[4]{\left(1 - \frac{N_{Ed}}{N_{cr,z}}\right) \left(1 - \frac{N_{Ed}}{N_{cr,TF}}\right)} :$$

$$C_{my} = C_{my,0}$$

$$C_{mz} = C_{mz,0}$$

$$C_{mLT} = 1,0$$

$$\text{If } \bar{\lambda}_0 > 0,2\sqrt{C_1} \sqrt[4]{\left(1 - \frac{N_{Ed}}{N_{cr,z}}\right) \left(1 - \frac{N_{Ed}}{N_{cr,TF}}\right)} :$$

$$C_{my} = C_{my,0} + (1 - C_{my,0}) \frac{\sqrt{\varepsilon_y} a_{LT}}{1 + \sqrt{\varepsilon_y} a_{LT}}$$

$$C_{mz} = C_{mz,0}$$

$$C_{mLT} = C_{my}^2 \frac{a_{LT}}{\sqrt{\left(1 - \frac{N_{Ed}}{N_{cr,z}}\right) \left(1 - \frac{N_{Ed}}{N_{cr,T}}\right)}} \geq 1$$

$$\varepsilon_y = \frac{M_{y,Ed}}{N_{Ed}} \frac{A}{W_{el,y}} \quad \text{for class 1, 2 and 3 cross-sections}$$

$$\varepsilon_y = \frac{M_{y,Ed}}{N_{Ed}} \frac{A_{eff}}{W_{eff,y}} \quad \text{for class 4 cross-sections}$$

$N_{cr,y}$ = elastic flexural buckling force about the y-y axis

$N_{cr,z}$ = elastic flexural buckling force about the z-z axis

$N_{cr,T}$ = elastic torsional buckling force

I_T = St. Venant torsional constant

I_y = second moment of area about y-y axis

Table A.2: Equivalent uniform moment factors $C_{mi,0}$

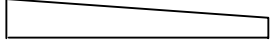
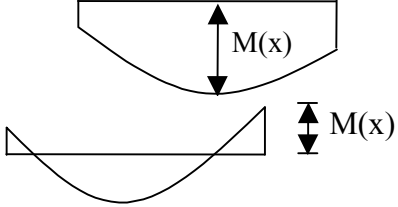
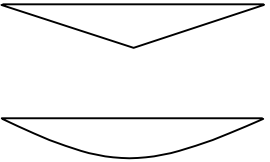
Moment diagram	$C_{mi,0}$
 <p>M_1 ψM_1 $-1 \leq \psi \leq 1$</p>	$C_{mi,0} = 0,79 + 0,21\psi_i + 0,36(\psi_i - 0,33) \frac{N_{Ed}}{N_{cr,i}}$
	$C_{mi,0} = 1 + \left(\frac{\pi^2 EI_i \delta_x }{L^2 M_{i,Ed}(x) } - 1 \right) \frac{N_{Ed}}{N_{cr,i}}$ <p>$M_{i,Ed}(x)$ is the maximum moment $M_{y,Ed}$ or $M_{z,Ed}$ δ_x is the maximum member displacement along the member</p>
	$C_{mi,0} = 1 - 0,18 \frac{N_{Ed}}{N_{cr,i}}$ $C_{mi,0} = 1 + 0,03 \frac{N_{Ed}}{N_{cr,i}}$

Annex B [informative] – Method 2: Interaction factors k_{ij} for interaction formula in 6.3.3(4)

Table B.1: Interaction factors k_{ij} for members not susceptible to torsional deformations

Interaction factors	Type of sections	Design assumptions	
		elastic cross-sectional properties class 3, class 4	plastic cross-sectional properties class 1, class 2
k_{yy}	I-sections RHS-sections	$C_{my} \left(1 + 0,6 \bar{\lambda}_y \frac{N_{Ed}}{\chi_y N_{Rk} / \gamma_{M1}} \right)$ $\leq C_{my} \left(1 + 0,6 \frac{N_{Ed}}{\chi_y N_{Rk} / \gamma_{M1}} \right)$	$C_{my} \left(1 + (\bar{\lambda}_y - 0,2) \frac{N_{Ed}}{\chi_y N_{Rk} / \gamma_{M1}} \right)$ $\leq C_{my} \left(1 + 0,8 \frac{N_{Ed}}{\chi_y N_{Rk} / \gamma_{M1}} \right)$
k_{yz}	I-sections RHS-sections	k_{zz}	$0,6 k_{zz}$
k_{zy}	I-sections RHS-sections	$0,8 k_{yy}$	$0,6 k_{yy}$
k_{zz}	I-sections	$C_{mz} \left(1 + 0,6 \bar{\lambda}_z \frac{N_{Ed}}{\chi_z N_{Rk} / \gamma_{M1}} \right)$ $\leq C_{mz} \left(1 + 0,6 \frac{N_{Ed}}{\chi_z N_{Rk} / \gamma_{M1}} \right)$	$C_{mz} \left(1 + (2\bar{\lambda}_z - 0,6) \frac{N_{Ed}}{\chi_z N_{Rk} / \gamma_{M1}} \right)$ $\leq C_{mz} \left(1 + 1,4 \frac{N_{Ed}}{\chi_z N_{Rk} / \gamma_{M1}} \right)$
	RHS-sections	$C_{mz} \left(1 + 0,6 \bar{\lambda}_z \frac{N_{Ed}}{\chi_z N_{Rk} / \gamma_{M1}} \right)$ $\leq C_{mz} \left(1 + 0,6 \frac{N_{Ed}}{\chi_z N_{Rk} / \gamma_{M1}} \right)$	$C_{mz} \left(1 + (\bar{\lambda}_z - 0,2) \frac{N_{Ed}}{\chi_z N_{Rk} / \gamma_{M1}} \right)$ $\leq C_{mz} \left(1 + 0,8 \frac{N_{Ed}}{\chi_z N_{Rk} / \gamma_{M1}} \right)$

For I- and H-sections and rectangular hollow sections under axial compression and uniaxial bending $M_{y,Ed}$ the coefficient k_{zy} may be $k_{zy} = 0$.

Table B.2: Interaction factors k_{ij} for members susceptible to torsional deformations

Interaction factors	Design assumptions	
	elastic cross-sectional properties class 3, class 4	plastic cross-sectional properties class 1, class 2
k_{yy}	k_{yy} from Table B.1	k_{yy} from Table B.1
k_{yz}	k_{yz} from Table B.1	k_{yz} from Table B.1
k_{zy}	$\left[1 - \frac{0,05 \bar{\lambda}_z}{(C_{mLT} - 0,25) \chi_z N_{Rk} / \gamma_{M1}} \frac{N_{Ed}}{\gamma_{M1}} \right]$ $\geq \left[1 - \frac{0,05}{(C_{mLT} - 0,25) \chi_z N_{Rk} / \gamma_{M1}} \frac{N_{Ed}}{\gamma_{M1}} \right]$	$\left[1 - \frac{0,1 \bar{\lambda}_z}{(C_{mLT} - 0,25) \chi_z N_{Rk} / \gamma_{M1}} \frac{N_{Ed}}{\gamma_{M1}} \right]$ $\geq \left[1 - \frac{0,1}{(C_{mLT} - 0,25) \chi_z N_{Rk} / \gamma_{M1}} \frac{N_{Ed}}{\gamma_{M1}} \right]$ <p>for $\bar{\lambda}_z < 0,4$:</p> $k_{zy} = 0,6 + \bar{\lambda}_z \leq 1 - \frac{0,1 \bar{\lambda}_z}{(C_{mLT} - 0,25) \chi_z N_{Rk} / \gamma_{M1}} \frac{N_{Ed}}{\gamma_{M1}}$

k_{zz}	k_{zz} from Table B.1	k_{zz} from Table B.1
----------	-------------------------	-------------------------

Table B.3: Equivalent uniform moment factors C_m in Tables B.1 and B.2

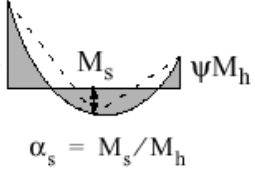
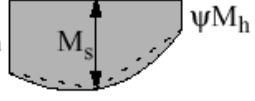
Moment diagram	range		C_{my} and C_{mz} and C_{mLT}	
			uniform loading	concentrated load
	$-1 \leq \psi \leq 1$		$0,6 + 0,4\psi \geq 0,4$	
 $\alpha_s = M_s / M_h$	$0 \leq \alpha_s \leq 1$	$-1 \leq \psi \leq 1$	$0,2 + 0,8\alpha_s \geq 0,4$	$0,2 + 0,8\alpha_s \geq 0,4$
	$-1 \leq \alpha_s < 0$	$0 \leq \psi \leq 1$	$0,1 - 0,8\alpha_s \geq 0,4$	$-0,8\alpha_s \geq 0,4$
		$-1 \leq \psi < 0$	$0,1(1-\psi) - 0,8\alpha_s \geq 0,4$	$0,2(-\psi) - 0,8\alpha_s \geq 0,4$
 $\alpha_h = M_h / M_s$	$0 \leq \alpha_h \leq 1$	$-1 \leq \psi \leq 1$	$0,95 + 0,05\alpha_h$	$0,90 + 0,10\alpha_h$
	$-1 \leq \alpha_h < 0$	$0 \leq \psi \leq 1$	$0,95 + 0,05\alpha_h$	$0,90 + 0,10\alpha_h$
		$-1 \leq \psi < 0$	$0,95 + 0,05\alpha_h(1+2\psi)$	$0,90 - 0,10\alpha_h(1+2\psi)$
For members with sway buckling mode the equivalent uniform moment factor should be taken $C_{my} = 0,9$ or $C_{Mz} = 0,9$ respectively.				
C_{my} , C_{mz} and C_{mLT} should be obtained according to the bending moment diagram between the relevant braced points as follows:				
moment factor	bending axis	points braced in direction		
C_{my}	y-y	z-z		
C_{mz}	z-z	y-y		
C_{mLT}	y-y	y-y		

Annex AB [informative] – Additional design provisions

AB.1 Structural analysis taking account of material non-linearities

(1)B In case of material non-linearities the action effects in a structure may be determined by incremental approach to the design loads to be considered for the relevant design situation.

(2)B In this incremental approach each permanent or variable action should be increased proportionally.

AB.2 Simplified provisions for the design of continuous floor beams

(1)B For continuous beams with slabs in buildings without cantilevers on which uniformly distributed loads are dominant, it is sufficient to consider only the following load arrangements:

- a) alternative spans carrying the design permanent and variable load ($\gamma_G G_k + \gamma_Q Q_k$), other spans carrying only the design permanent load $\gamma_G G_k$
- b) any two adjacent spans carrying the design permanent and variable loads ($\gamma_G G_k + \gamma_Q Q_k$), all other spans carrying only the design permanent load $\gamma_G G_k$

NOTE 1 a) applies to sagging moments, b) to hogging moments.

NOTE 2 This annex is intended to be transferred to EN 1990 in a later stage.

Annex BB [informative] – Buckling of components of building structures

BB.1 Flexural buckling of members in triangulated and lattice structures

BB.1.1 General

(1)B For chord members generally and for out-of-plane buckling of web members, the buckling length L_{cr} may be taken as equal to the system length L , see BB.1.3(1)B, unless a smaller value can be justified by analysis.

(2)B The buckling length L_{cr} of an I or H section chord member may be taken as $0,9L$ for in-plane buckling and $1,0L$ for out-of-plane buckling, unless a smaller value is justified by analysis.

(3)B Web members may be designed for in-plane buckling using a buckling length smaller than the system length, provided the chords supply appropriate end restraint and the end connections supply appropriate fixity (at least 2 bolts if bolted).

(4)B Under these conditions, in normal triangulated structures the buckling length L_{cr} of web members for in-plane buckling may be taken as $0,9L$, except for angle sections, see BB.1.2.

BB.1.2 Angles as web members

(1)B Provided that the chords supply appropriate end restraint to web members made of angles and the end connections of such web members supply appropriate fixity (at least two bolts if bolted), the eccentricities may be neglected and end fixities allowed for in the design of angles as web members in compression. The effective slenderness ratio $\bar{\lambda}_{eff}$ may be obtained as follows:

$$\begin{aligned}\bar{\lambda}_{eff,v} &= 0,35 + 0,7\bar{\lambda}_v && \text{for buckling about v-v axis} \\ \bar{\lambda}_{eff,y} &= 0,50 + 0,7\bar{\lambda}_y && \text{for buckling about y-y axis} \\ \bar{\lambda}_{eff,z} &= 0,50 + 0,7\bar{\lambda}_z && \text{for buckling about z-z axis}\end{aligned}\tag{BB.1}$$

where $\bar{\lambda}$ is as defined in 6.3.1.2.

(2)B When only one bolt is used for end connections of angle web members the eccentricity should be taken into account using 6.2.9 and the buckling length L_{cr} should be taken as equal to the system length L .

BB.1.3 Hollow sections as members

(1)B The buckling length L_{cr} of a hollow section chord member may be taken as $0,9L$ for both in-plane and out-of-plane buckling, where L is the system length for the relevant plane. The in-plane system length is the distance between the joints. The out-of-plane system length is the distance between the lateral supports, unless a smaller value is justified by analysis.

(2)B The buckling length L_{cr} of a hollow section brace member (web member) with bolted connections may be taken as $1,0L$ for both in-plane and out-of-plane buckling.

(3)B For latticed girders with parallel chords and braces, for which the brace to chord diameter or width ratio β is less than $0,6$ the buckling length L_{cr} of a hollow section brace member without cropping or flattening, welded around its perimeter to hollow section chords, may generally be taken as $0,75L$ for both in-plane and out-of-plane buckling, unless smaller values may be justified by tests or by calculations.

NOTE The National Annex may give more information on buckling lengths.

BB.2 Continuous restraints

BB.2.1 Continuous lateral restraints

(1)B If trapezoidal sheeting according to EN 1993-1-3 is connected to a beam and the condition expressed by equation (BB.2) is met, the beam at the connection may be regarded as being laterally restrained in the plane of the sheeting.

$$S \geq \left(EI_w \frac{\pi^2}{L^2} + GI_t + EI_z \frac{\pi^2}{L^2} 0,25h^2 \right) \frac{70}{h^2} \quad (\text{BB.2})$$

where S is the shear stiffness (per unit of beam length) provided by the sheeting to the beam regarding its deformation in the plane of the sheeting to be connected to the beam at each rib.

I_w is the warping constant

I_t is the torsion constant

I_z is the second moment of area of the cross section about the minor axis of the cross section

L is the beam length

h is the depth of the beam

If the sheeting is connected to a beam at every second rib only, S should be substituted by $0,20S$.

NOTE Equation (BB.2) may also be used to determine the lateral stability of beam flanges used in combination with other types of cladding than trapezoidal sheeting, provided that the connections are of suitable design.

BB.2.2 Continuous torsional restraints

(1)B A beam may be considered as sufficiently restraint from torsional deformations if

$$C_{\theta,k} > \frac{M_{pl,k}^2}{EI_z} K_{\theta} K_{\nu} \quad (\text{BB.3})$$

where $C_{\theta,k}$ = rotational stiffness (per unit of beam length) provided to the beam by the stabilizing continuum (e.g. roof structure) and the connections

K_{ν} = 0,35 for elastic analysis

K_{ν} = 1,00 for plastic analysis

K_{θ} = factor for considering the moment distribution see Table BB.1 and the type of restraint

$M_{pl,k}$ = characteristic value of the plastic moment of the beam

Table BB.1: Factor K_9 for considering the moment distribution and the type of restraint

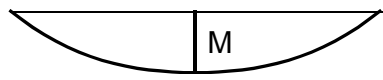
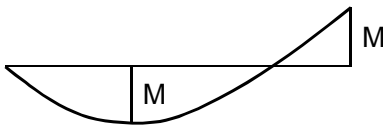
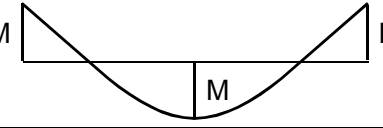
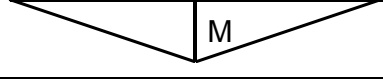
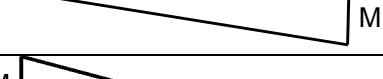
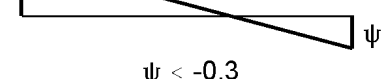
Case	Moment distribution	without translational restraint	with translational restraint
1		4,0	0
2a		3,5	0,12
2b			0,23
3		2,8	0
4		1,6	1,0
5	 $\psi \leq -0,3$	1,0	0,7

(2)B The rotational stiffness provided by the stabilizing continuum to the beam may be calculated from

$$\frac{1}{C_{9,k}} = \frac{1}{C_{9R,k}} + \frac{1}{C_{9C,k}} + \frac{1}{C_{9D,k}} \tag{BB.4}$$

where $C_{9R,k}$ = rotational stiffness (per unit of the beam length) provided by the stabilizing continuum to the beam assuming a stiff connection to the member

$C_{9C,k}$ = rotational stiffness (per unit of the beam length) of the connection between the beam and the stabilizing continuum

$C_{9D,k}$ = rotational stiffness (per unit of the beam length) deduced from an analysis of the distortional deformations of the beam cross sections, where the flange in compression is the free one; where the compression flange is the connected one or where distortional deformations of the cross sections may be neglected (e.g. for usual rolled profiles)

$C_{9D,k} = \infty$

NOTE For more information see EN 1993-1-3.

BB.3 Stable lengths of segment containing plastic hinges for out-of-plane buckling

BB.3.1 Uniform members made of rolled sections or equivalent welded I-sections

BB.3.1.1 Stable lengths between adjacent lateral restraints

(1)B Lateral torsional buckling effects may be ignored where the length L of the segment of a member between the restrained section at a plastic hinge location and the adjacent lateral restraint is not greater than L_m , where:

$$L_m = \frac{38i_z}{\sqrt{\frac{1}{57,4} \left(\frac{N_{Ed}}{A} \right) + \frac{1}{756 C_1^2} \left(\frac{W_{pl,y}^2}{AI_t} \right) \left(\frac{f_y}{235} \right)^2}} \quad (\text{BB.5})$$

where N_{Ed} is the design value of the compression force [N] in the member

A is the cross section area [mm²] of the member

$W_{pl,y}$ is the plastic section modulus of the member

I_t is the torsion constant of the member

f_y is the yield strength in [N/mm²]

C_1 is a factor depending on the loading and end conditions to be taken from literature

provided that the member is restrained at the hinge as required by 6.3.5 and that the other end of the segment is restrained

- either by a lateral restraint to the compression flange where one flange is in compression throughout the length of the segment,
- or by a torsional restraint,
- or by a lateral restraint at the end of the segment and a torsional restraint to the member at a distance that satisfies the requirements for L_s ,

see Figure BB.1, Figure BB.2 and Figure BB3.

NOTE In general L_s is greater than L_m .

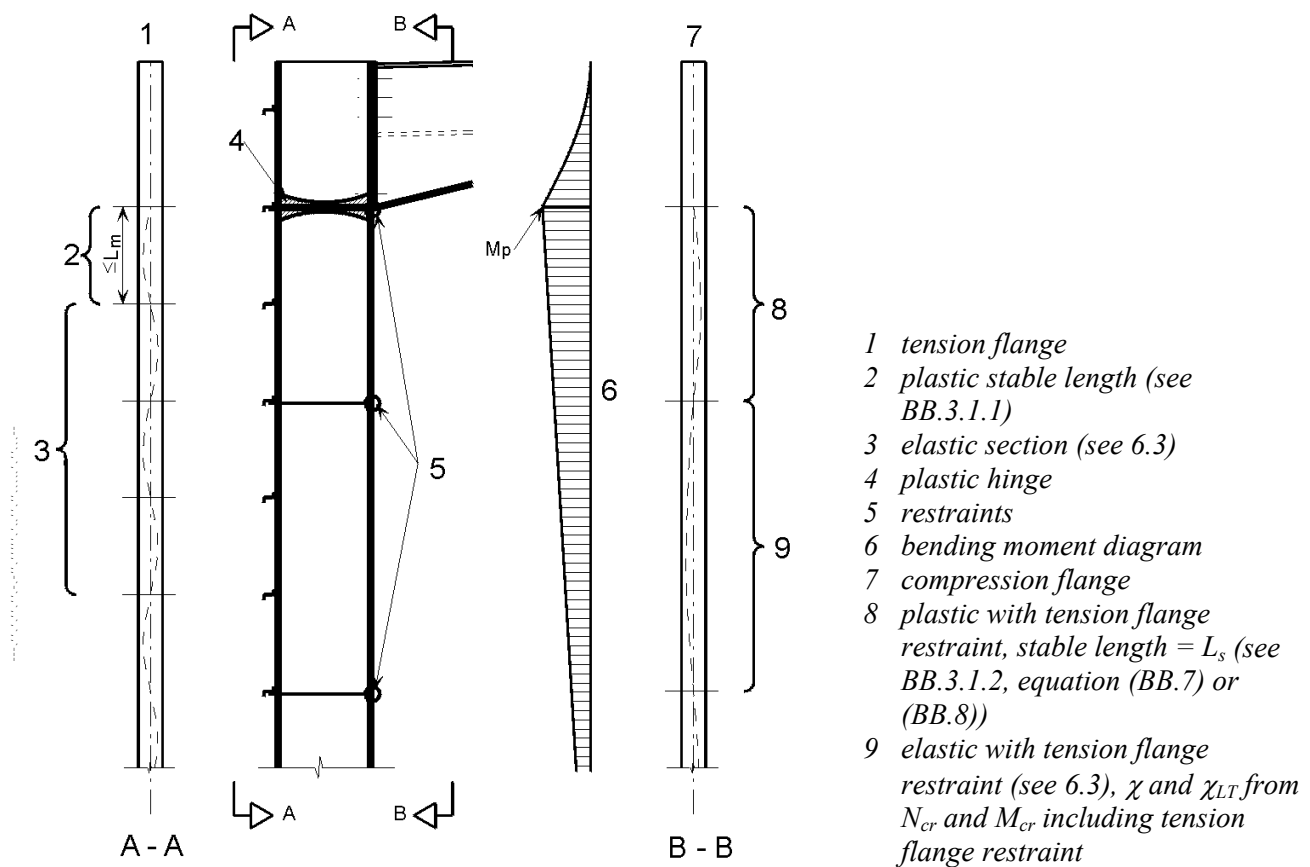

Figure BB.1: Checks in a member without a haunch

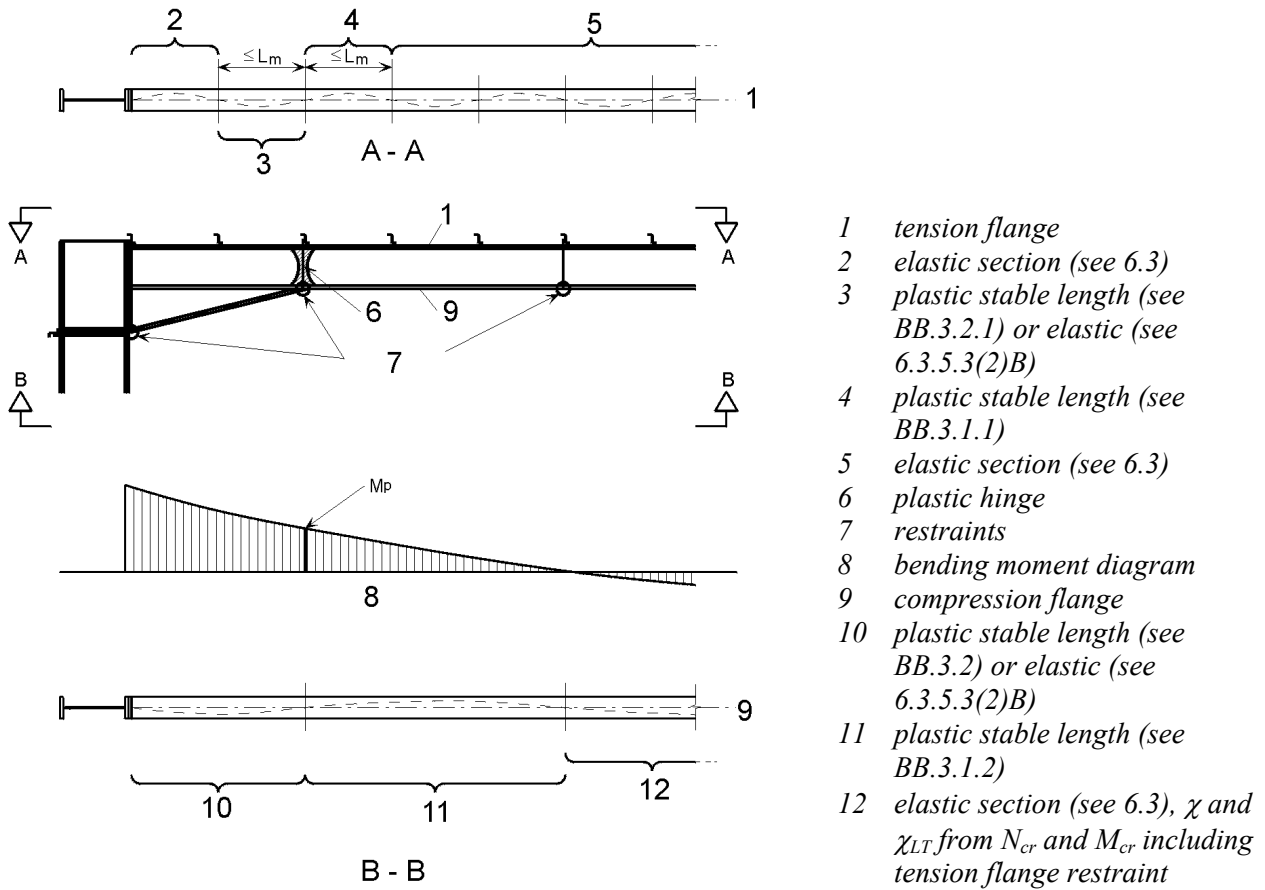

Figure BB.2: Checks in a member with a three flange haunch

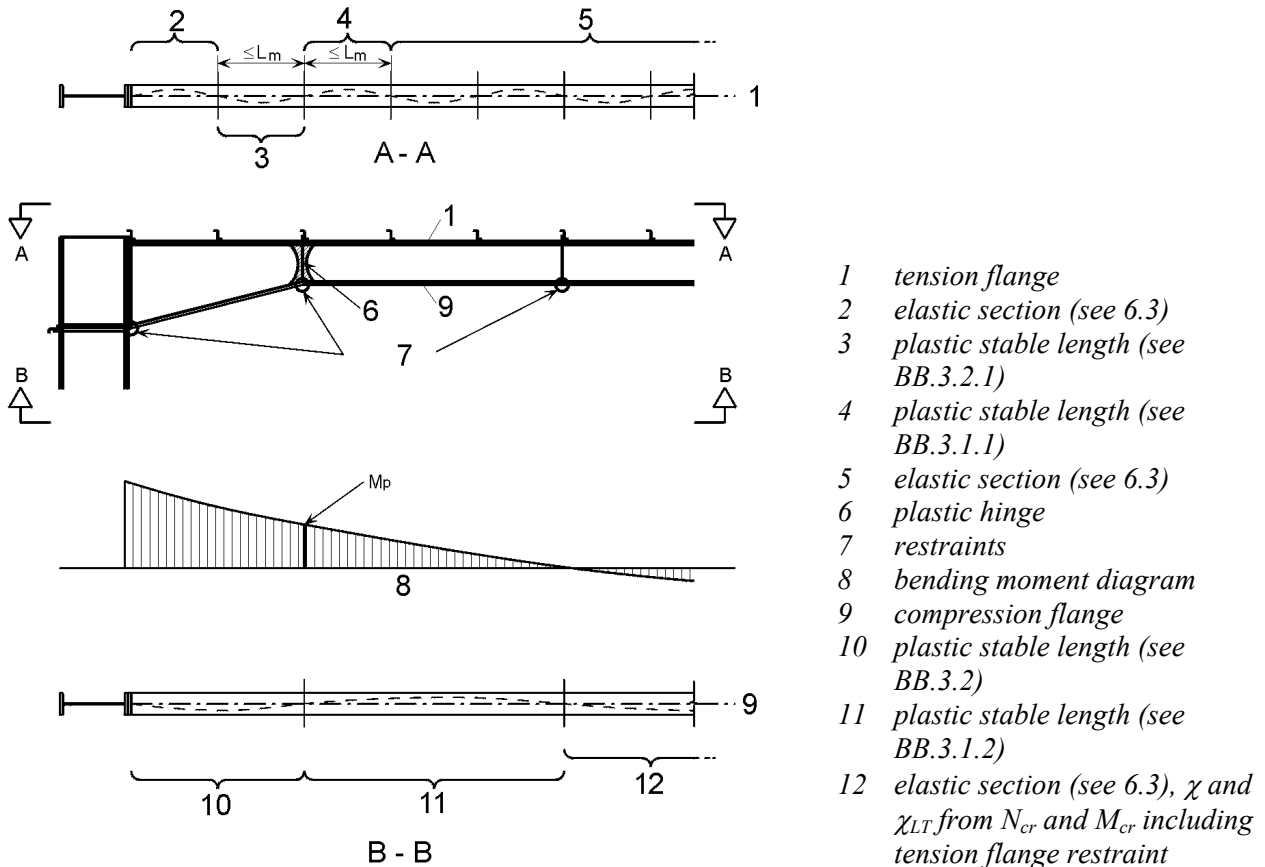

Figure BB.3: Checks in a member with a two flange haunch

BB.3.1.2 Stable length between torsional restraints

(1)B Lateral torsional buckling effects may be ignored where the length L of the segment of a member between the restrained section at a plastic hinge location and the adjacent torsional restraint subject to a constant moment is not greater than L_k , provided that

- the member is restrained at the hinge as required by 6.3.5 and
- there are one or more intermediate lateral restraints between the torsional restraints at a spacing that satisfies the requirements for L_m , see BB.3.1.1,

where

$$L_k = \frac{\left(5,4 + \frac{600f_y}{E}\right) \left(\frac{h}{t_f}\right) i_z}{\sqrt{5,4 \left(\frac{f_y}{E}\right) \left(\frac{h}{t_f}\right)^2 - 1}} \quad (\text{BB.6})$$

(2)B Lateral torsional buckling effects may be ignored where the length L of the segment of a member between the restrained section at a plastic hinge location and the adjacent torsional restraint subject to a linear moment gradient and axial compression is not greater than L_s , provided that

- the member is restrained at the hinge as required by 6.3.5 and
- there are one or more intermediate lateral restraints between the torsional restraints at a spacing that satisfies the requirements for L_m , see BB.3.1.1,

$$\text{where } L_s = \sqrt{C_m} L_k \left(\frac{M_{pl,y,Rk}}{M_{N,y,Rk} + aN_{Ed}} \right) \quad (\text{BB.7})$$

C_m is the modification factor for linear moment gradient, see BB.3.3.1;

a is the distance between the centroid of the member with the plastic hinge and the centroid of the restraint members;

$M_{pl,y,Rk}$ is the characteristic plastic moment resistance of the cross section about the y-y axis

$M_{N,y,Rk}$ is the characteristic plastic moment resistance of the cross section about the y-y axis with reduction due to the axial force N_{Ed}

(3)B Lateral torsional buckling effects may be ignored where the length L of a segment of a member between the restrained section at a plastic hinge location and the adjacent torsional restraint subject to a non linear moment gradient and axial compression is not greater than L_s , provided that

- the member is restrained at the hinge as required by 6.3.5 and
- there are one or more intermediate lateral restraints between the torsional restraints at a spacing that satisfies the requirements for L_m , see BB.3.1.1

$$\text{where } L_s = \sqrt{C_n} L_k \quad (\text{BB.8})$$

C_n is the modification factor for non-linear moment gradient, see BB.3.3.2,

see Figure BB.1, Figure BB.2 and Figure BB.3.

BB.3.2 Haunched or tapered members made of rolled sections or equivalent welded I-sections

BB.3.2.1 Stable length between adjacent lateral restraints

(1)B Lateral torsional buckling effects may be ignored where the length L of the segment of a member between the restrained section at a plastic hinge location and the adjacent lateral restraint is not greater than L_m , where

- for three flange haunches (see Figure BB.2)

$$L_m = \frac{38i_z}{\sqrt{\frac{1}{57,4} \left(\frac{N_{Ed}}{A} \right) + \frac{1}{756 C_1^2} \left(\frac{W_{pl,y}^2}{AI_t} \right) \left(\frac{f_y}{235} \right)^2}} \quad (\text{BB.9})$$

- for two flange haunches (see Figure BB.3)

$$L_m = 0,85 \frac{38i_z}{\sqrt{\frac{1}{57,4} \left(\frac{N_{Ed}}{A} \right) + \frac{1}{756 C_1^2} \left(\frac{W_{pl,y}^2}{AI_t} \right) \left(\frac{f_y}{235} \right)^2}} \quad (\text{BB.10})$$

where N_{Ed} is the design value of the compression force [N] in the member

$\frac{W_{pl,y}^2}{AI_t}$ is the maximum value in the segment

A is the cross sectional area [mm²] at the location where $\frac{W_{pl,y}^2}{AI_t}$ is a maximum of the tapered member

$W_{pl,y}$ is the plastic section modulus of the member

I_t is the torsional constant of the member

f_y is the yield strength in [N/mm²]

i_z is the minimum value of the radius of gyration in the segment

provided that the member is restrained at the hinge as required by 6.3.5 and that the other end of segment is restrained

- either by a lateral restraint to the compression flange where one flange is in compression throughout the length of the segment,
- or by a torsional restraint,
- or by a lateral restraint at the end of the segment and a torsional restraint to the member at a distance that satisfies the requirements for L_s .

BB.3.2.2 Stable length between torsional restraints

(1)B For non uniform members with constant flanges under linear or non-linear moment gradient and axial compression, lateral torsional buckling effects may be ignored where the length L of the segment of a member between the restrained section at a plastic hinge location and the adjacent torsional restraint is not greater than L_s , provided that

- the member is restrained at the hinge as required by 6.3.5 and
- there are one or more intermediate lateral restraints between the torsional restraints at a spacing that satisfies the requirements for L_m , see BB.3.2.1,

where

- for three flange haunches (see Figure BB.2)

$$L_s = \frac{\sqrt{C_n} L_k}{c} \quad (\text{BB.11})$$

- for two flange haunches (see Figure BB.3)

$$L_s = 0,85 \frac{\sqrt{C_n} L_k}{c} \quad (\text{BB.12})$$

where L_k is the length derived for a uniform member with a cross-section equal to the shallowest section, see BB.3.1.2

C_n see BB.3.3.2

c is the taper factor defined in BB.3.3.3

BB.3.3 Modification factors for moment gradients in members laterally restrained along the tension flange

BB.3.3.1 Linear moment gradients

(1)B The modification factor C_m may be determined from

$$C_m = \frac{1}{B_0 + B_1\beta_t + B_2\beta_t^2} \quad (\text{BB.13})$$

in which

$$B_0 = \frac{1 + 10\eta}{1 + 20\eta}$$

$$B_1 = \frac{5\sqrt{\eta}}{\pi + 10\sqrt{\eta}}$$

$$B_2 = \frac{0,5}{1 + \pi\sqrt{\eta}} - \frac{0,5}{1 + 20\eta}$$

$$\eta = \frac{N_{crE}}{N_{crT}}$$

$$N_{crE} = \frac{\pi^2 EI_z}{L_t^2}$$

L_t is the distance between the torsional restraints

$N_{crT} = \frac{1}{i_s^2} \left(\frac{\pi^2 EI_z a^2}{L_t^2} + \frac{\pi^2 EI_w}{L_t^2} + GI_t \right)$ is the elastic critical torsional buckling force for an I-section between restraints to both flanges at spacing L_t with intermediate lateral restraints to the tension flange.

$$i_s^2 = i_y^2 + i_z^2 + a^2$$

where a is the distance between the centroid of the member and the centroid of the restraining members, such as purlins restraining rafters

β_t is the ratio of the algebraically smaller end moment to the larger end moment. Moments that produce compression in the non-restrained flange should be taken as positive. If the ratio is less than $-1,0$ the value of β_t should be taken as $-1,0$, see Figure BB.4.

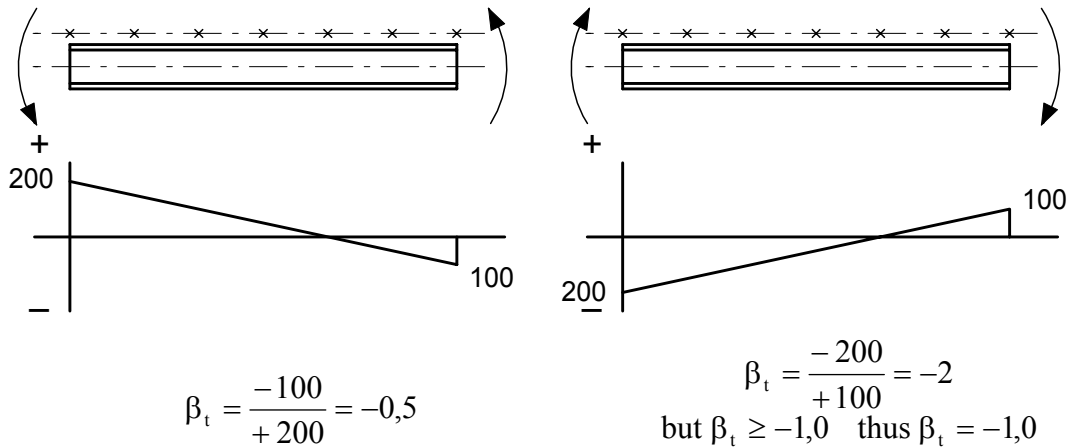

Figure BB.4: Value of β_t

BB.3.3.2 Non linear moment gradients

(1)B The modification factor C_n may be determined from

$$C_n = \frac{12}{[R_1 + 3R_2 + 4R_3 + 3R_4 + R_5 + 2(R_S - R_E)]} \tag{BB.14}$$

in which R_1 to R_5 are the values of R according to (2)B at the ends, quarter points and mid-length, see Figure BB.5, and only positive values of R should be included.

In addition, only positive values of $(R_S - R_E)$ should be included, where

- R_E is the greater of R_1 or R_5
- R_S is the maximum value of R anywhere in the length L_y

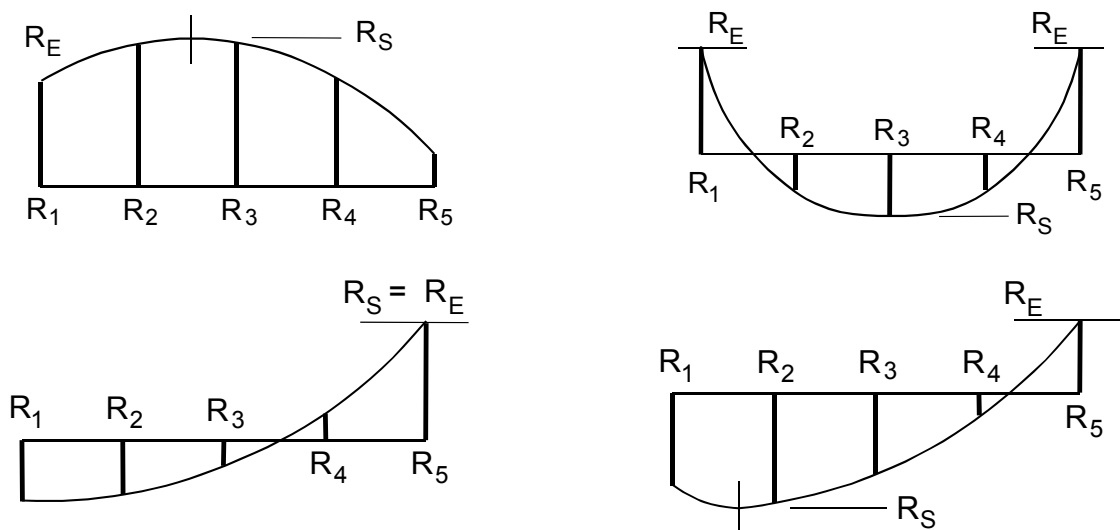

Figure BB.5: Moment ratios

(2)B The value of R should be obtained from:

$$R = \frac{M_{y,Ed} + a N_{Ed}}{f_y W_{pl,y}} \tag{BB.15}$$

where a is the distance between the centroid of the member and the centroid of the restraining members, such as purlins restraining rafters.

BB.3.3.3 Taper factor

(1)B For a non uniform member with constant flanges, for which $h \geq 1,2b$ and $h/t_f \geq 20$ the taper factor c should be obtained as follows:

- for tapered members or segments, see Figure BB.6(a):

$$c = 1 + \frac{3}{\left(\frac{h}{t_f} - 9\right)} \left(\frac{h_{\max}}{h_{\min}} - 1\right)^{2/3} \tag{BB.16}$$

- for haunched members or segments, see Figures BB.6(b) and BB.6(c):

$$c = 1 + \frac{3}{\left(\frac{h}{t_f} - 9\right)} \left(\frac{h_h}{h_s}\right)^{2/3} \sqrt{\frac{L_h}{L_y}} \tag{BB.17}$$

where h_h is the additional depth of the haunch or taper, see Figure BB.6;
 h_{\max} is the maximum depth of cross-section within the length L_y , see Figure BB.6;
 h_{\min} is the minimum depth of cross-section within the length L_y , see Figure BB.6;
 h_s is the vertical depth of the un-haunched section, see Figure BB.6;
 L_h is the length of haunch within the length L_y , see Figure BB.6;
 L_y is the length between points at which the compression flange is laterally restrained.

(h/t_f) is to be derived from the shallowest section.

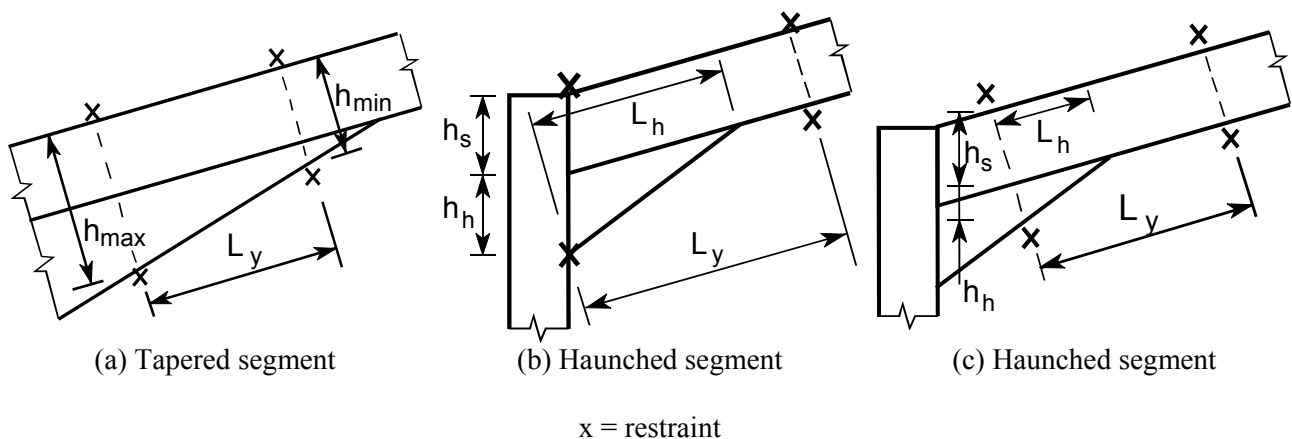

Figure BB.6: Dimensions defining taper factor

BSI — British Standards Institution

BSI is the independent national body responsible for preparing British Standards. It presents the UK view on standards in Europe and at the international level. It is incorporated by Royal Charter.

Revisions

British Standards are updated by amendment or revision. Users of British Standards should make sure that they possess the latest amendments or editions.

It is the constant aim of BSI to improve the quality of our products and services. We would be grateful if anyone finding an inaccuracy or ambiguity while using this British Standard would inform the Secretary of the technical committee responsible, the identity of which can be found on the inside front cover.
Tel: +44 (0)20 8996 9000. Fax: +44 (0)20 8996 7400.

BSI offers members an individual updating service called PLUS which ensures that subscribers automatically receive the latest editions of standards.

Buying standards

Orders for all BSI, international and foreign standards publications should be addressed to Customer Services. Tel: +44 (0)20 8996 9001.
Fax: +44 (0)20 8996 7001. Email: orders@bsi-global.com. Standards are also available from the BSI website at <http://www.bsi-global.com>.

In response to orders for international standards, it is BSI policy to supply the BSI implementation of those that have been published as British Standards, unless otherwise requested.

Information on standards

BSI provides a wide range of information on national, European and international standards through its Library and its Technical Help to Exporters Service. Various BSI electronic information services are also available which give details on all its products and services. Contact the Information Centre.
Tel: +44 (0)20 8996 7111. Fax: +44 (0)20 8996 7048. Email: info@bsi-global.com.

Subscribing members of BSI are kept up to date with standards developments and receive substantial discounts on the purchase price of standards. For details of these and other benefits contact Membership Administration.
Tel: +44 (0)20 8996 7002. Fax: +44 (0)20 8996 7001.
Email: membership@bsi-global.com.

Information regarding online access to British Standards via British Standards Online can be found at <http://www.bsi-global.com/bsonline>.

Further information about BSI is available on the BSI website at <http://www.bsi-global.com>.

Copyright

Copyright subsists in all BSI publications. BSI also holds the copyright, in the UK, of the publications of the international standardization bodies. Except as permitted under the Copyright, Designs and Patents Act 1988 no extract may be reproduced, stored in a retrieval system or transmitted in any form or by any means – electronic, photocopying, recording or otherwise – without prior written permission from BSI.

This does not preclude the free use, in the course of implementing the standard, of necessary details such as symbols, and size, type or grade designations. If these details are to be used for any other purpose than implementation then the prior written permission of BSI must be obtained.

Details and advice can be obtained from the Copyright & Licensing Manager.
Tel: +44 (0)20 8996 7070. Fax: +44 (0)20 8996 7553.
Email: copyright@bsi-global.com.