

MONGE, Gaspard

Geometría descriptiva, lecciones dadas en las escuelas normales / traducido por Agustín de Betancourt. Madrid : Imprenta Real, 1803

En la envoltura de la primera lámina aparece: 25 láminas de la Geometría descriptiva de Betancourt grabadas por Esteve

XXV grabados. Cobre, talla dulce ; 225 x 165 mm
Real Academia de Bellas Artes de San Fernando.

Calcografía Nacional

Sign. R.1295 a 1319

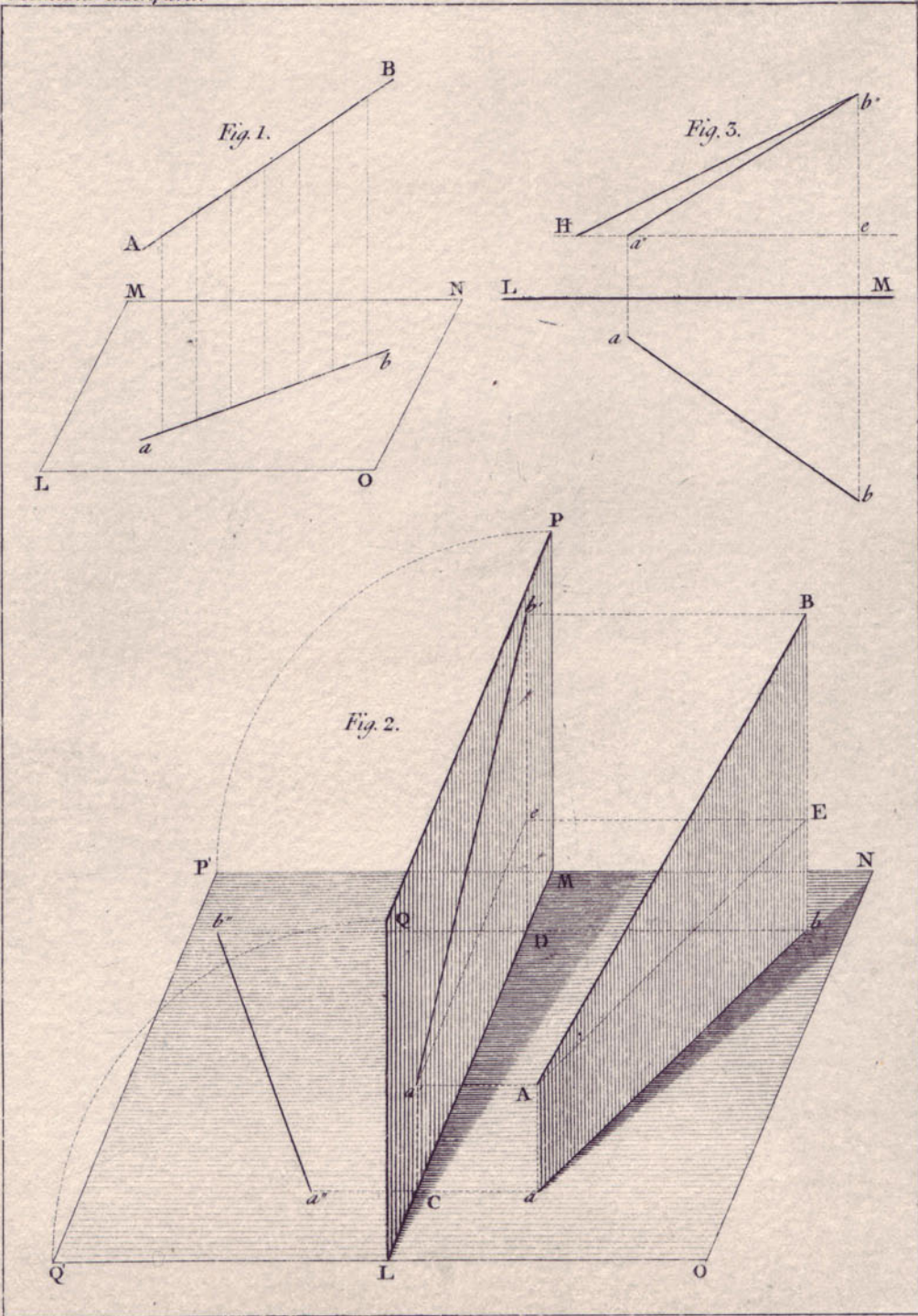

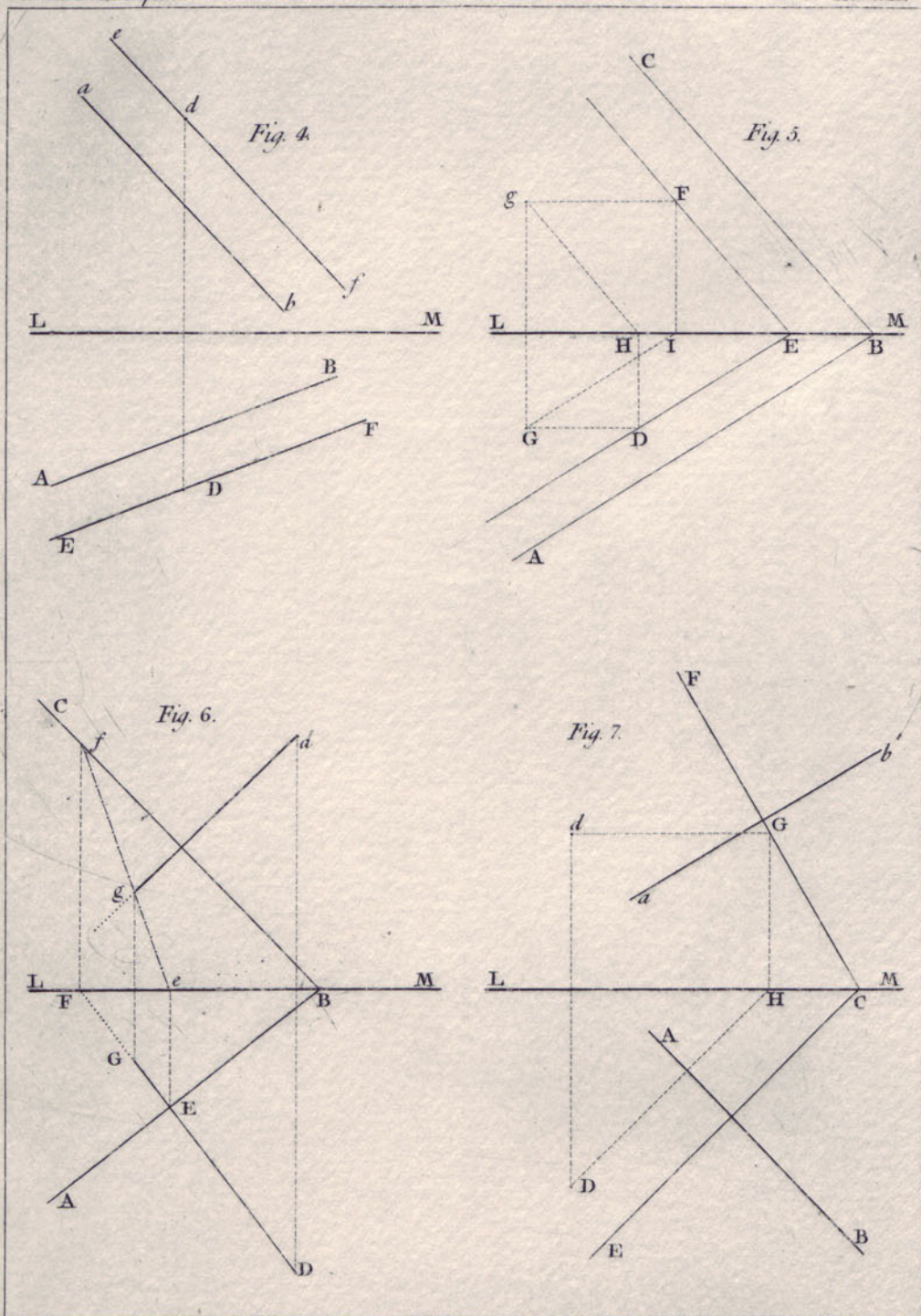

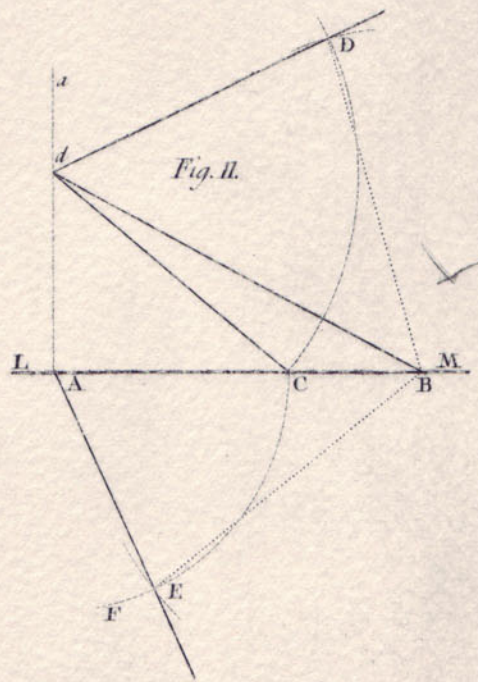
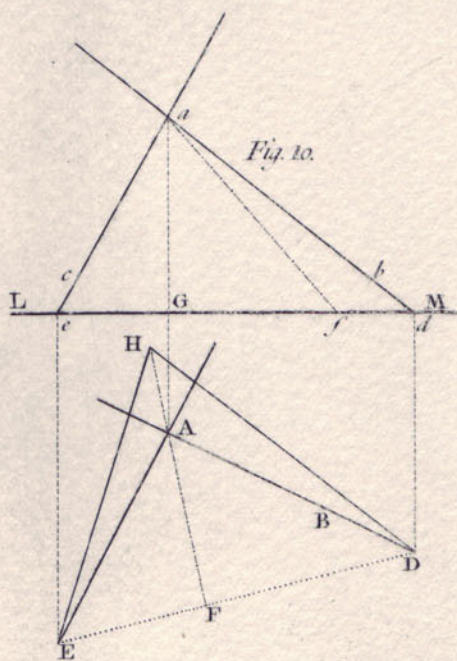
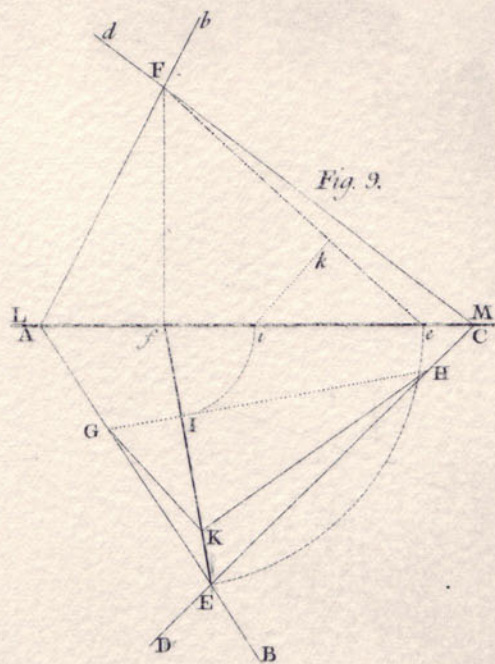
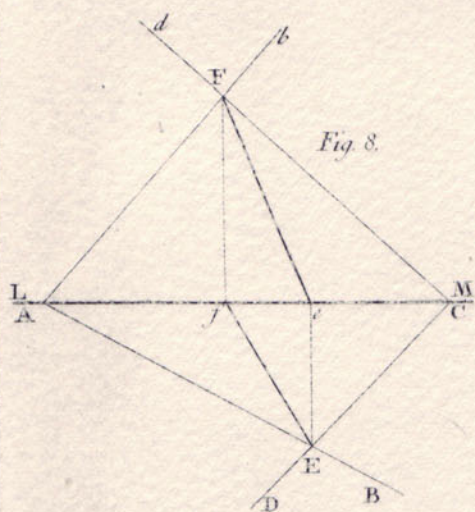

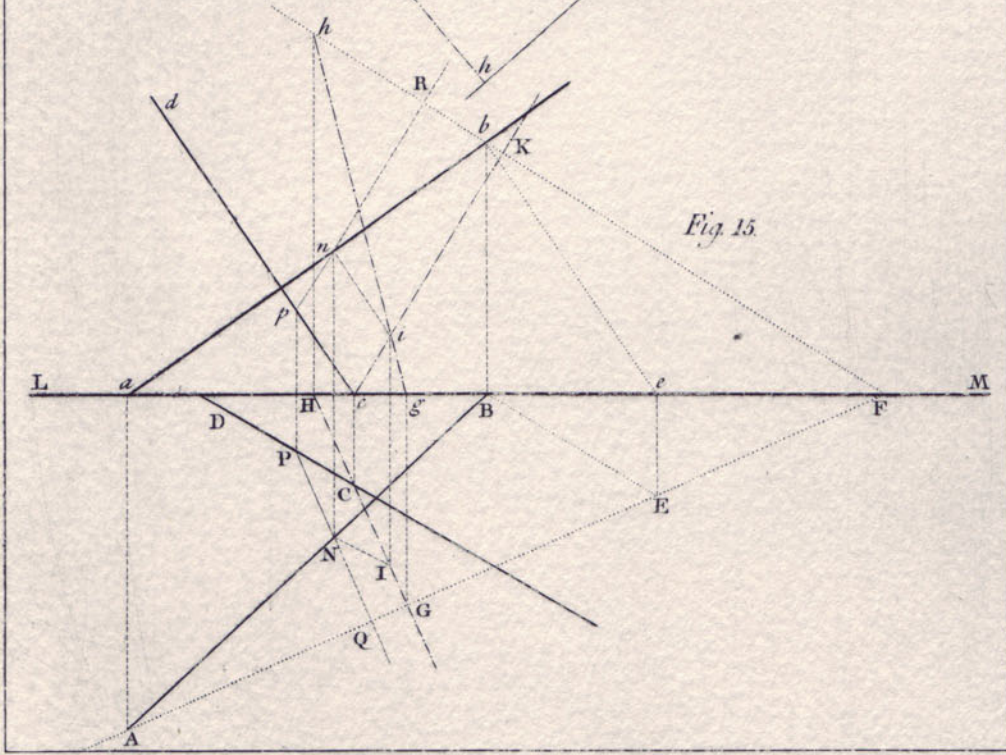
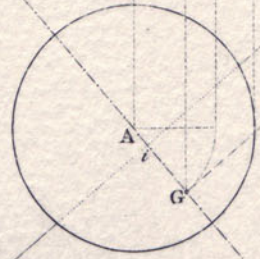
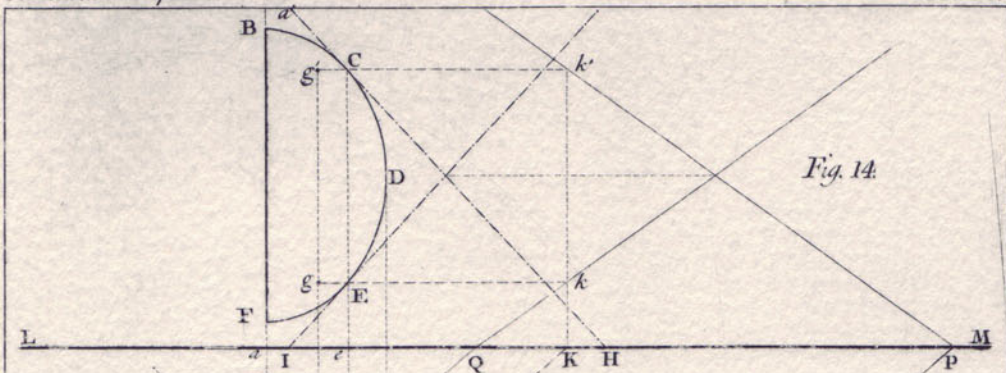

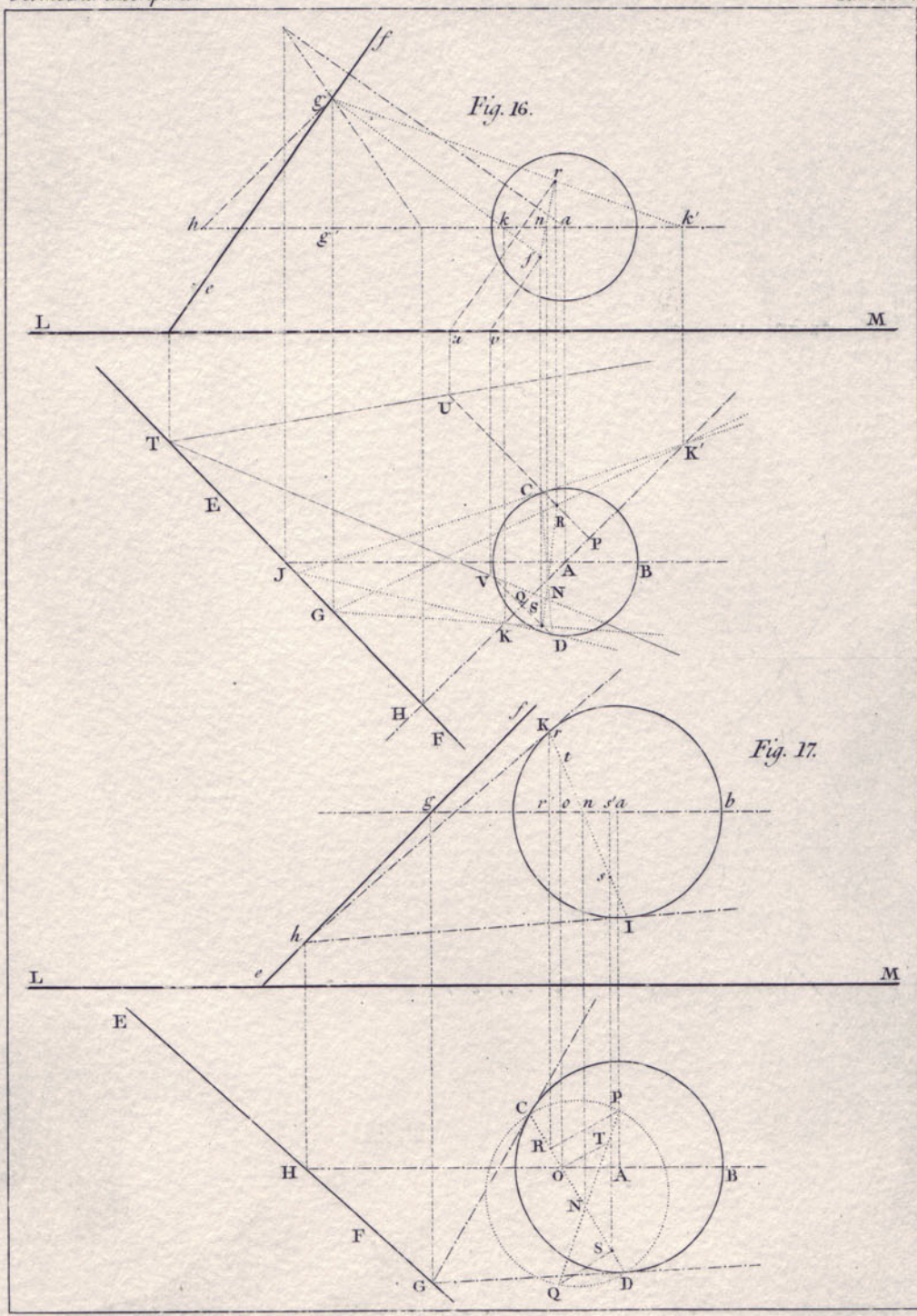

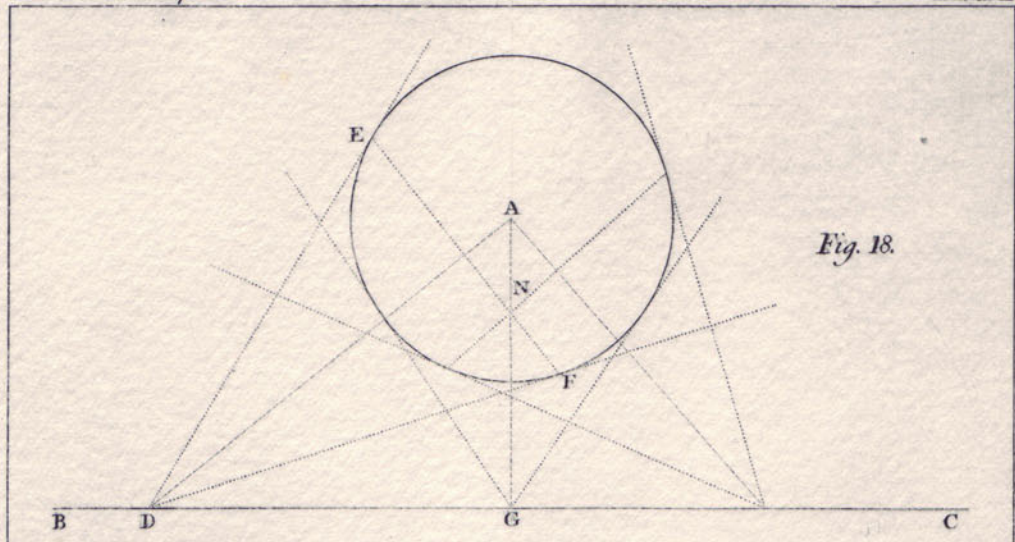

Fig. 18.

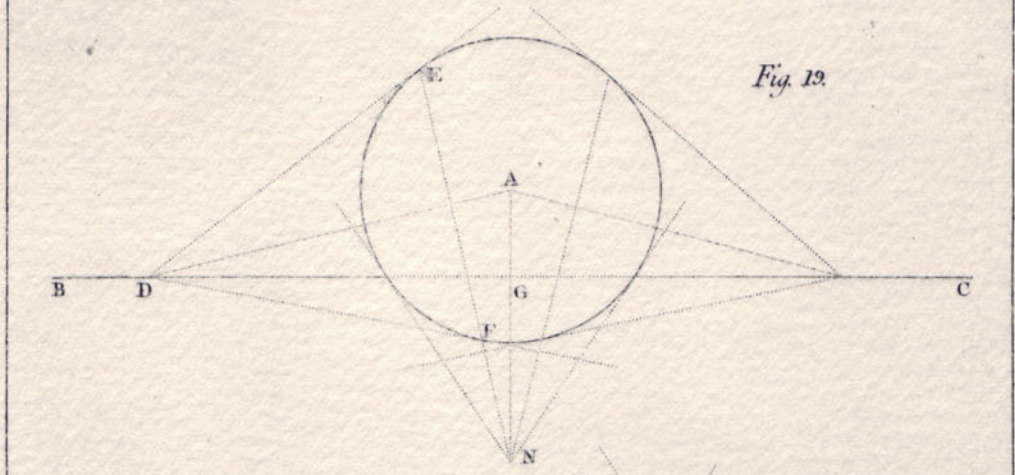

Fig. 19.

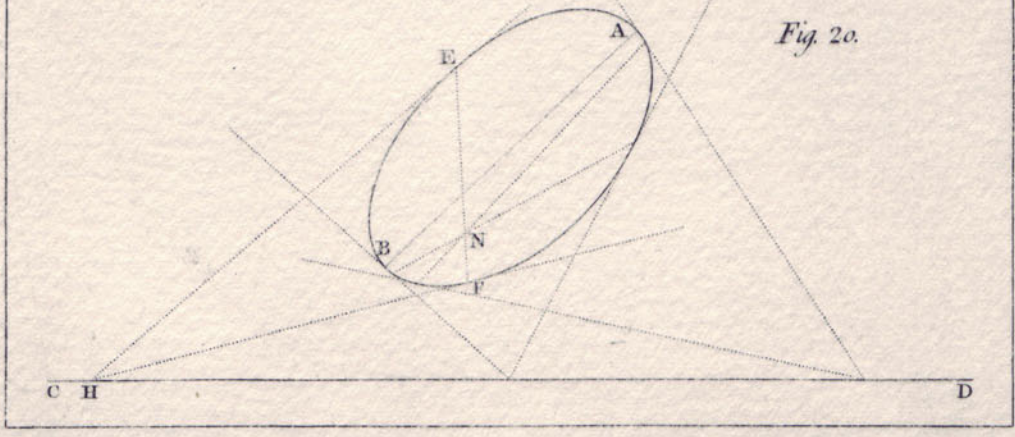
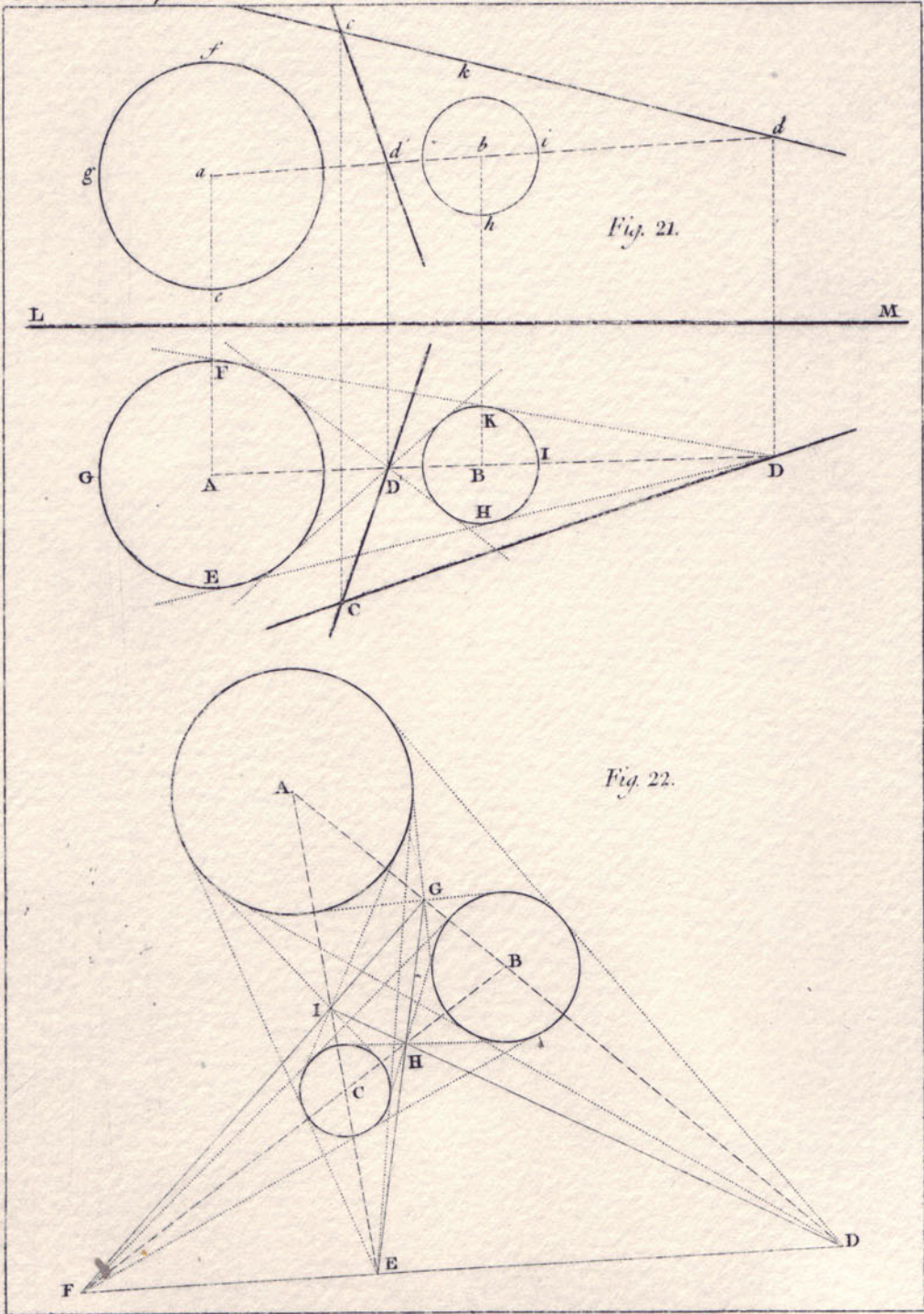
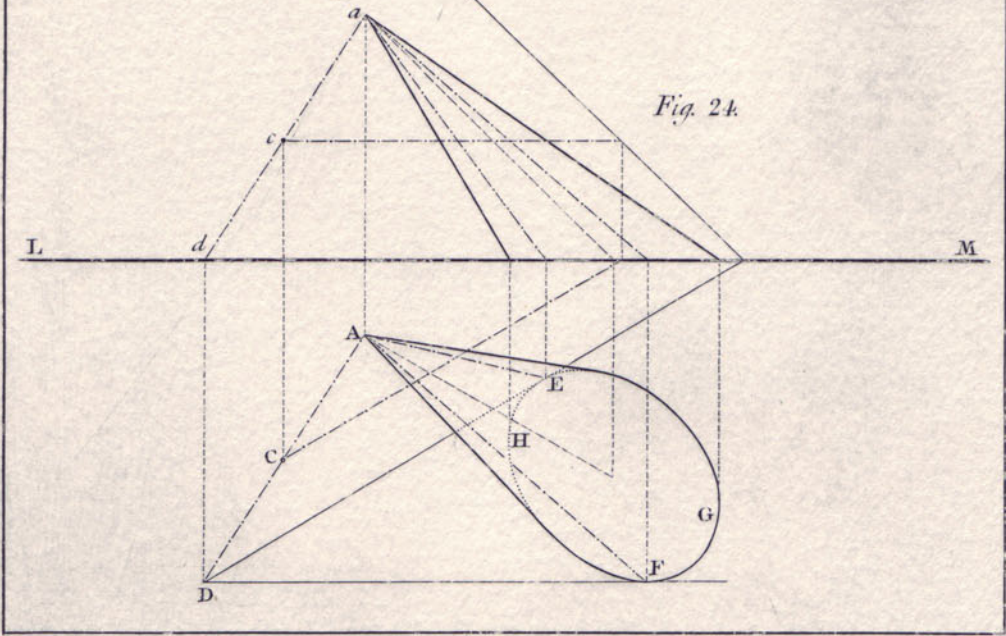
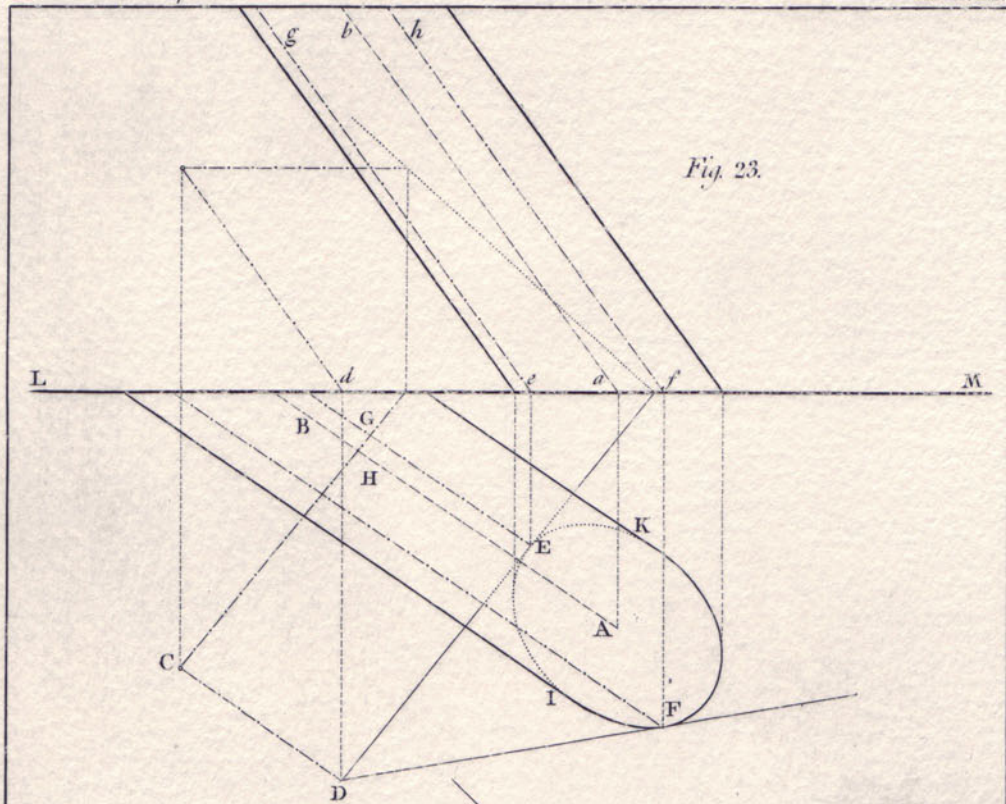

Fig. 20.





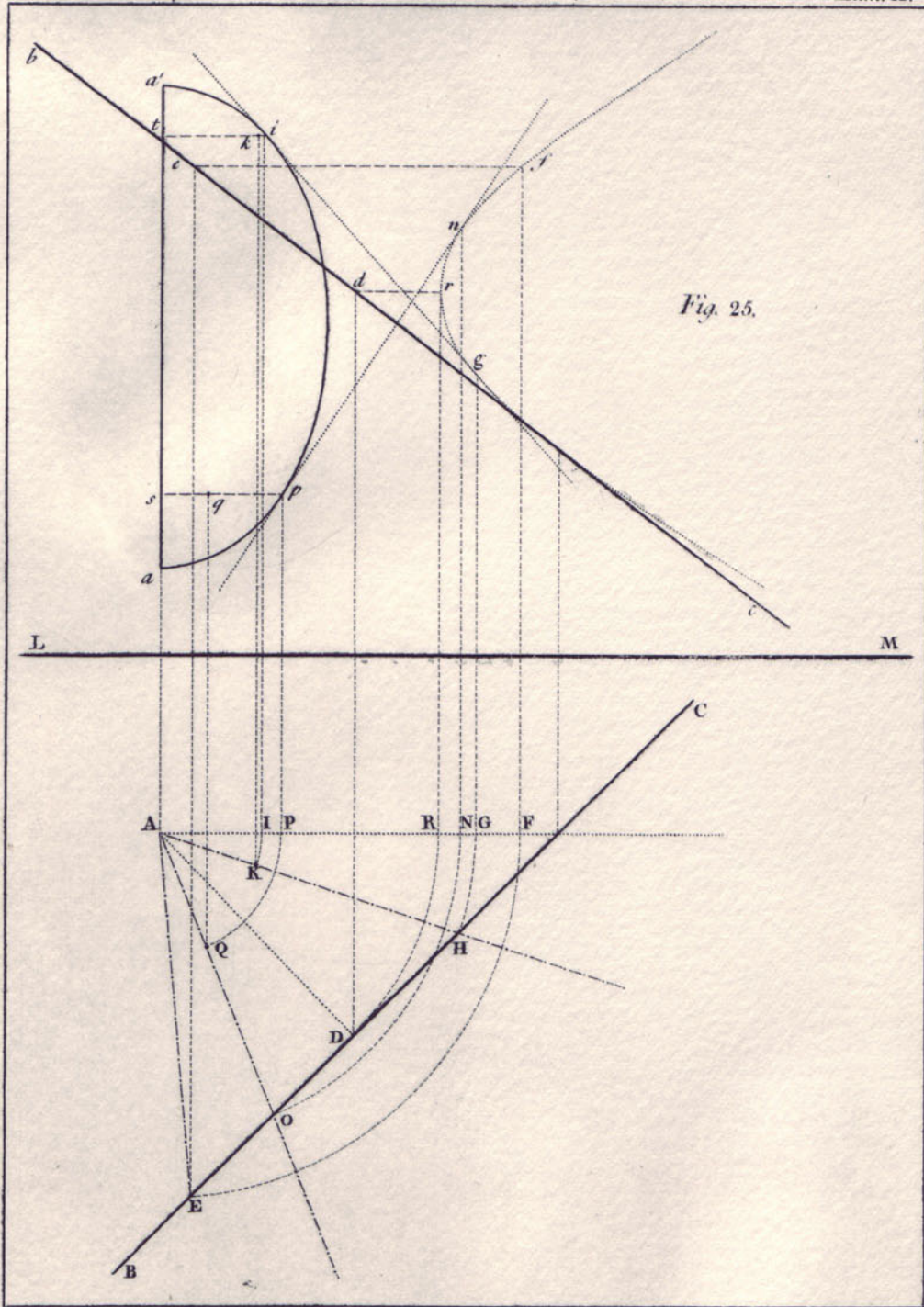
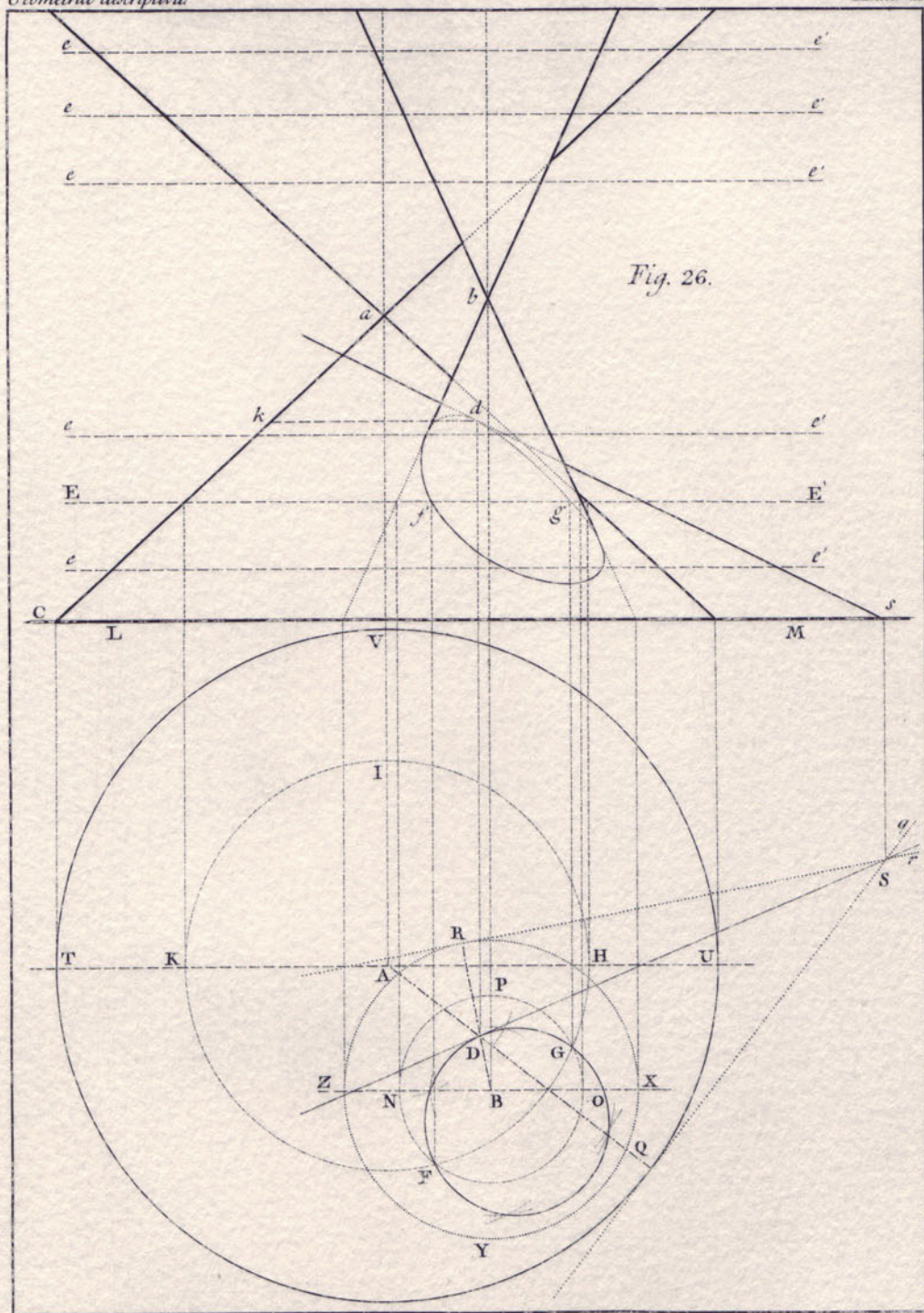

Fig. 25.



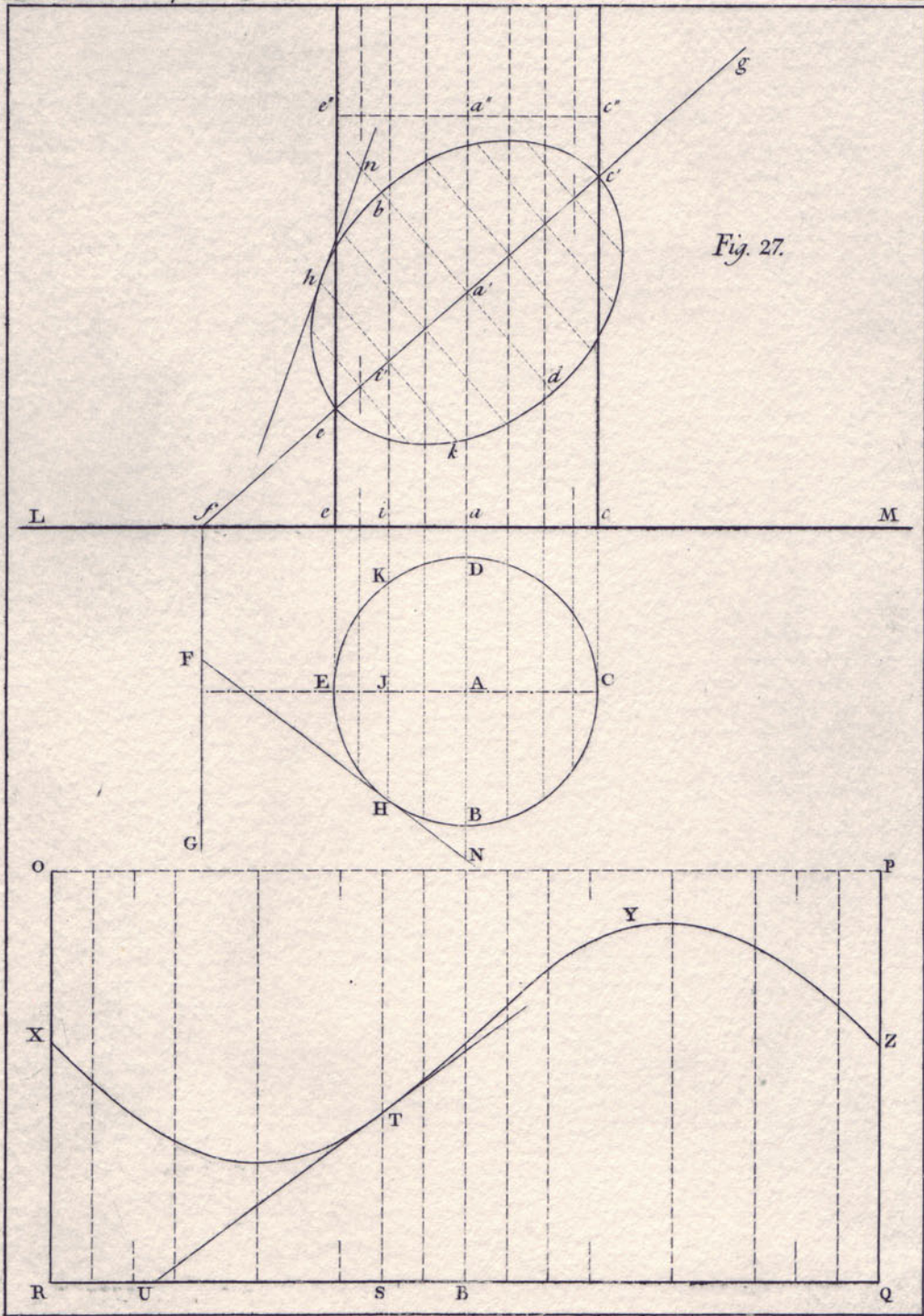

Fig. 27.

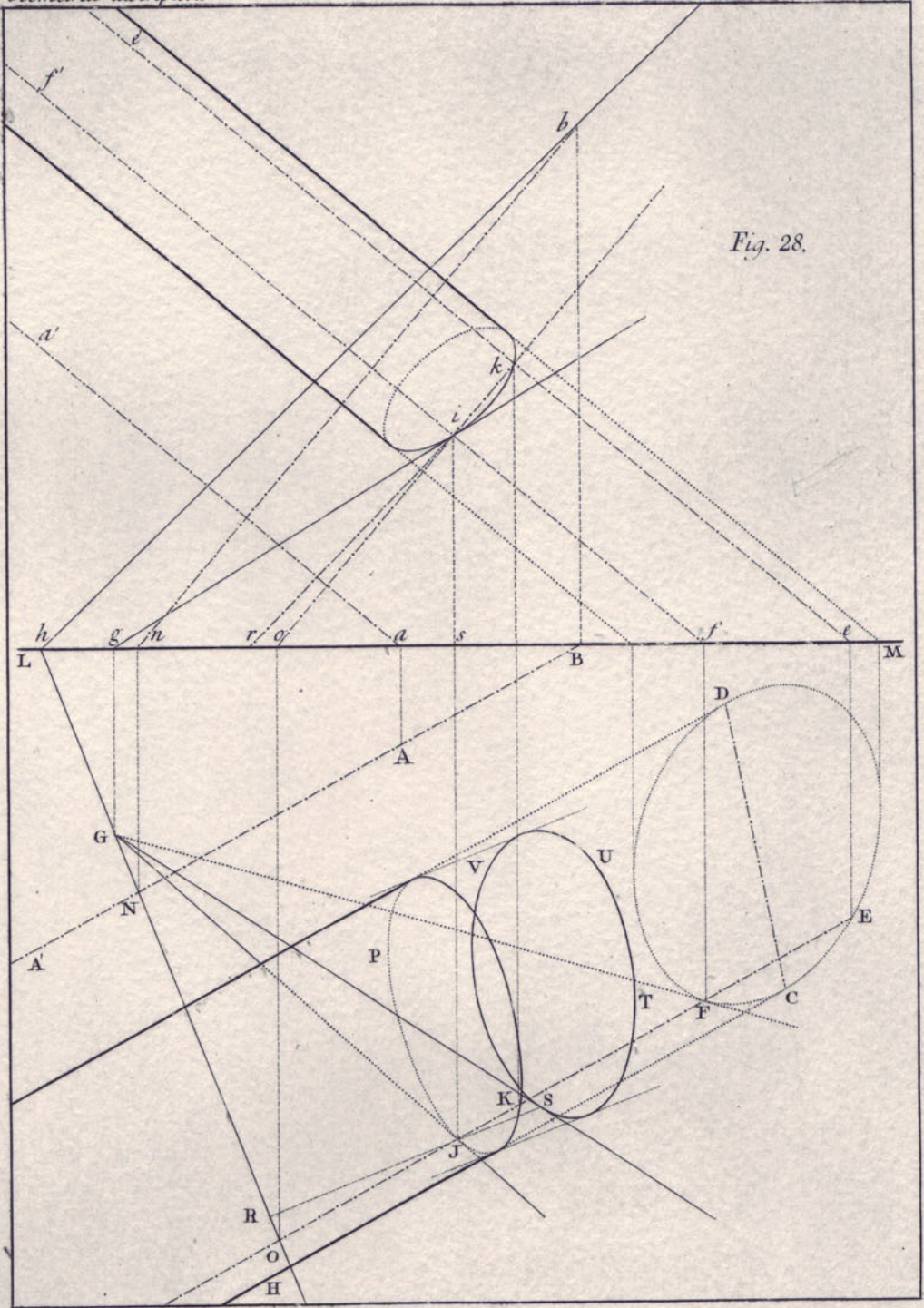

Fig. 28.

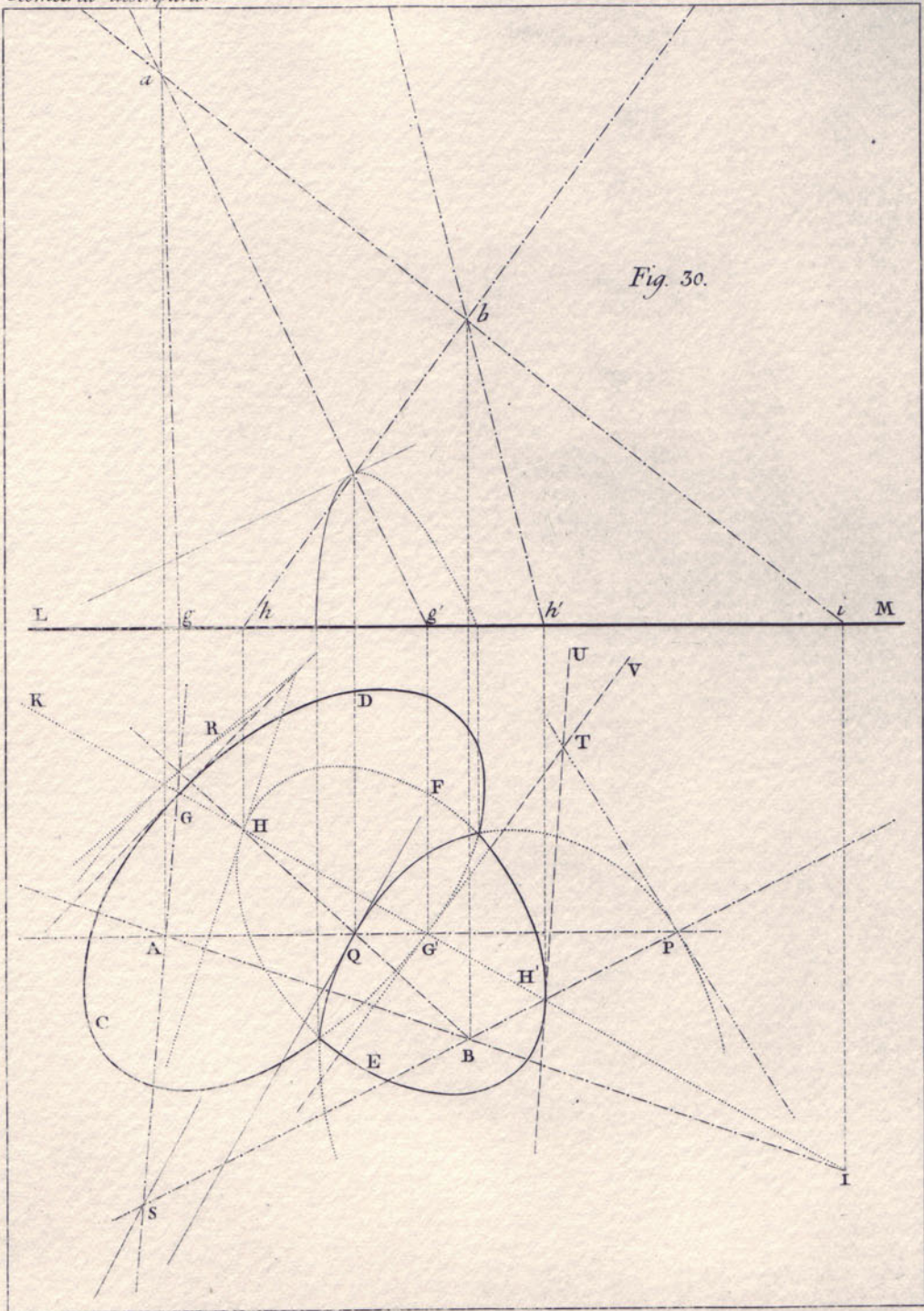

Fig. 30.

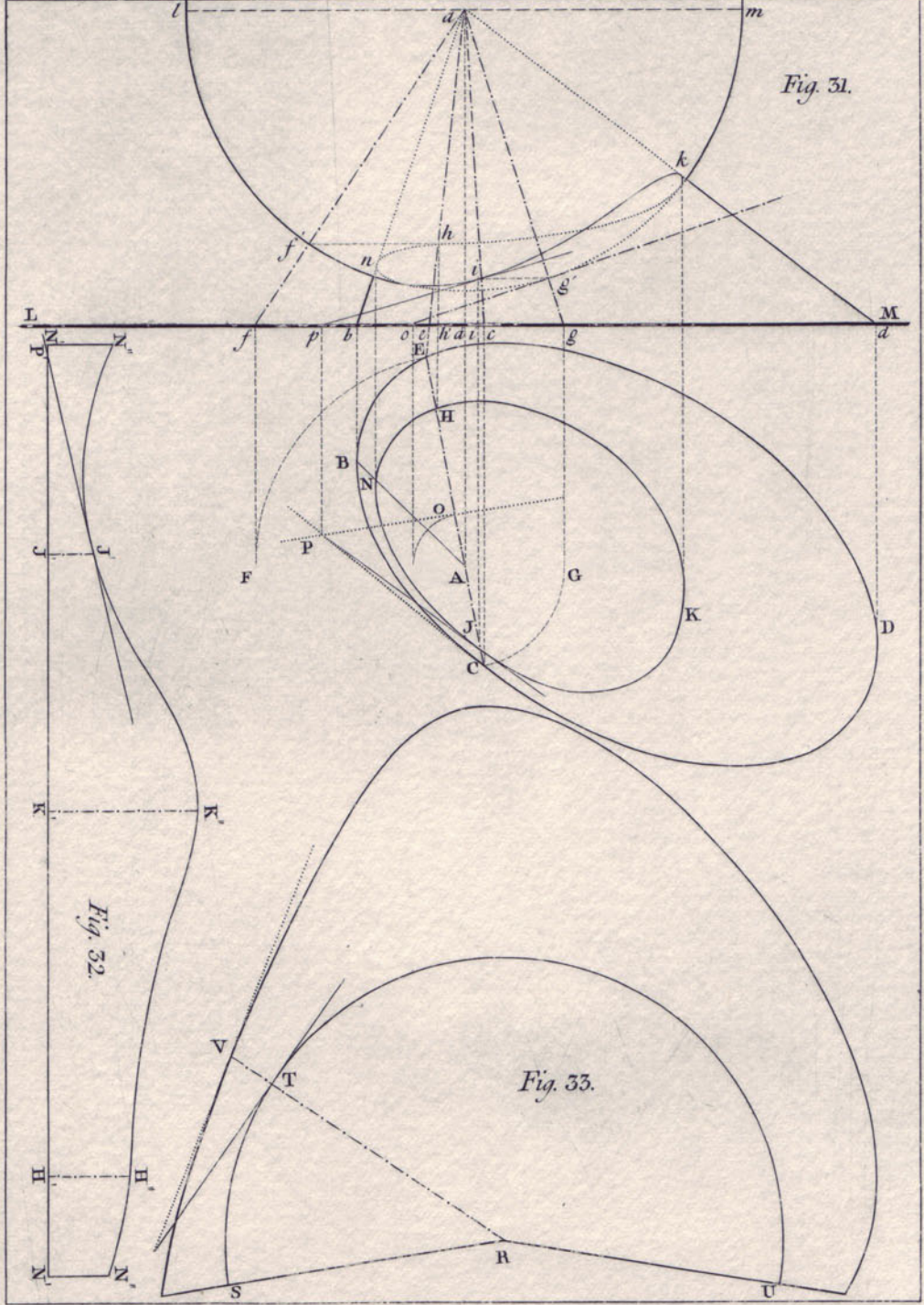

Fig. 31.

Fig. 32.

Fig. 33.

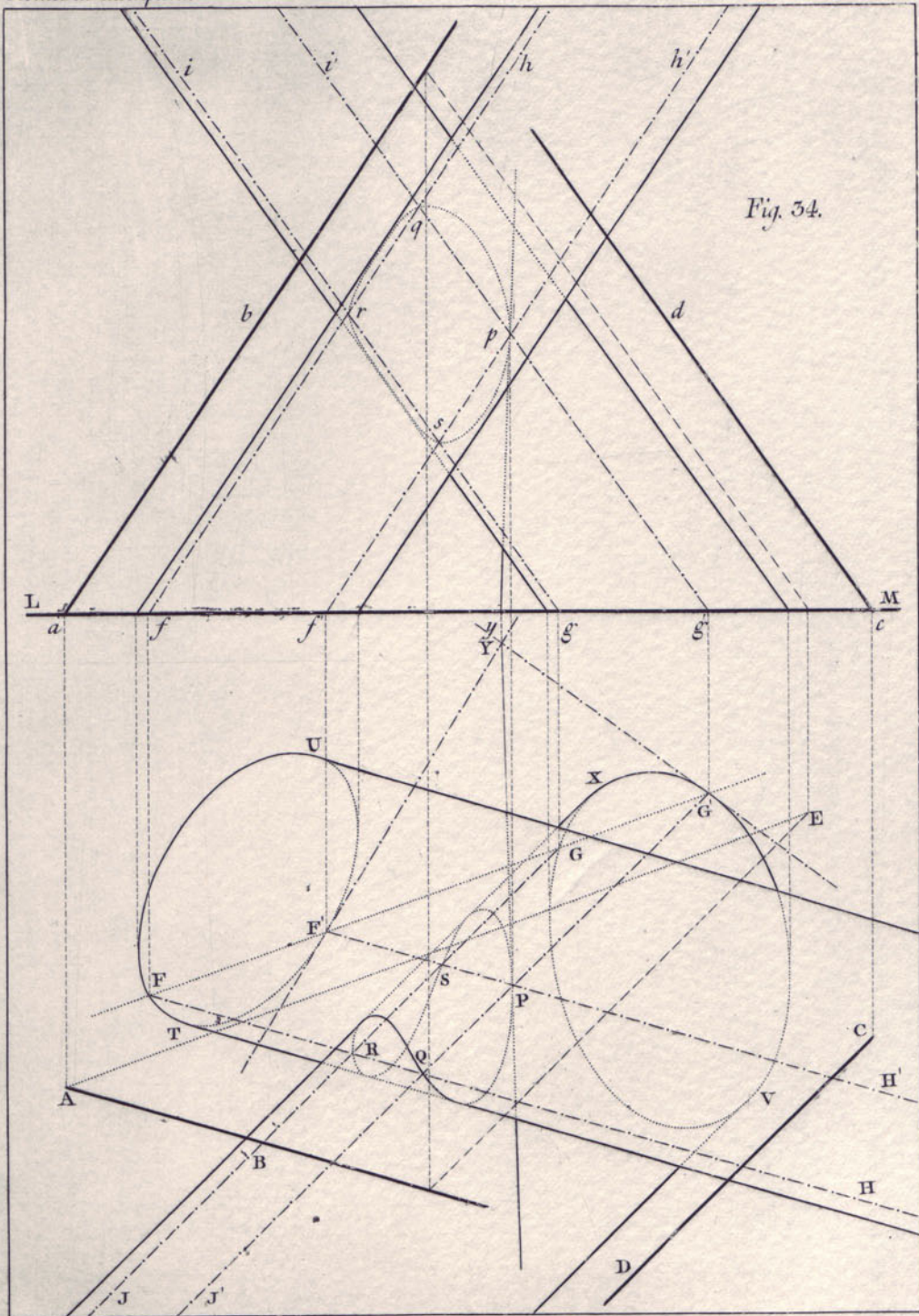

Fig. 54.

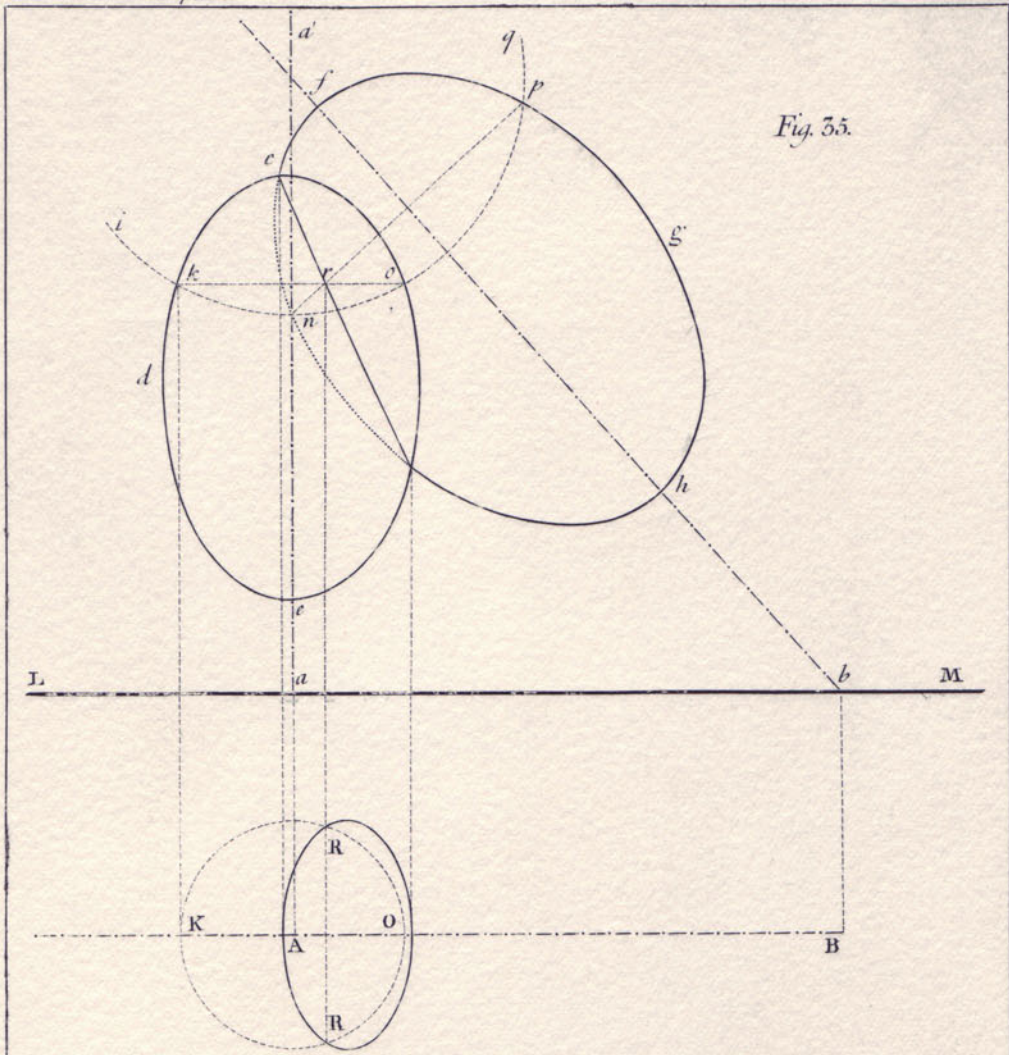

Fig. 36.

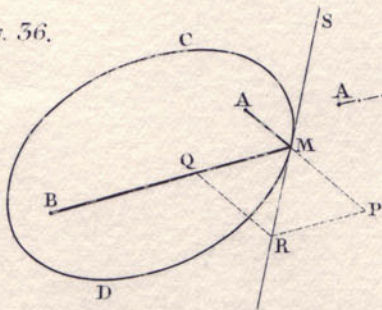
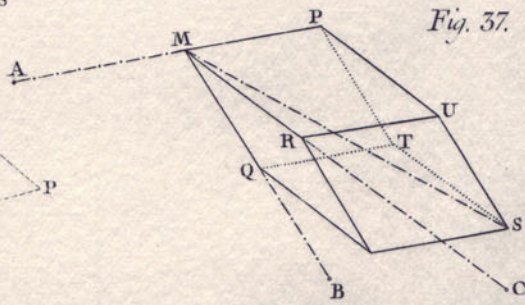

Fig. 37.



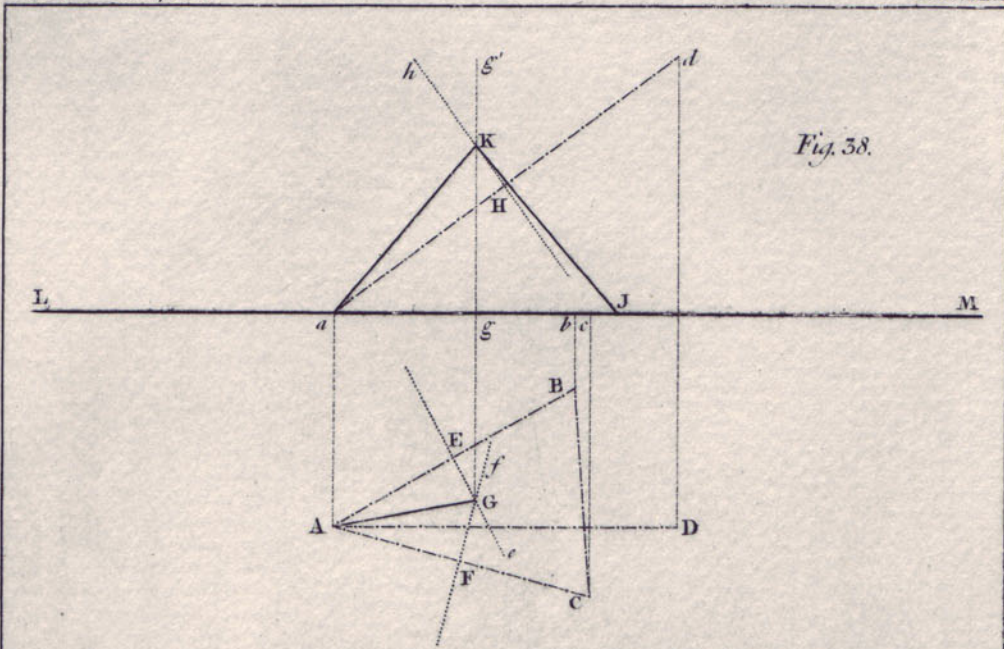

Fig. 38.

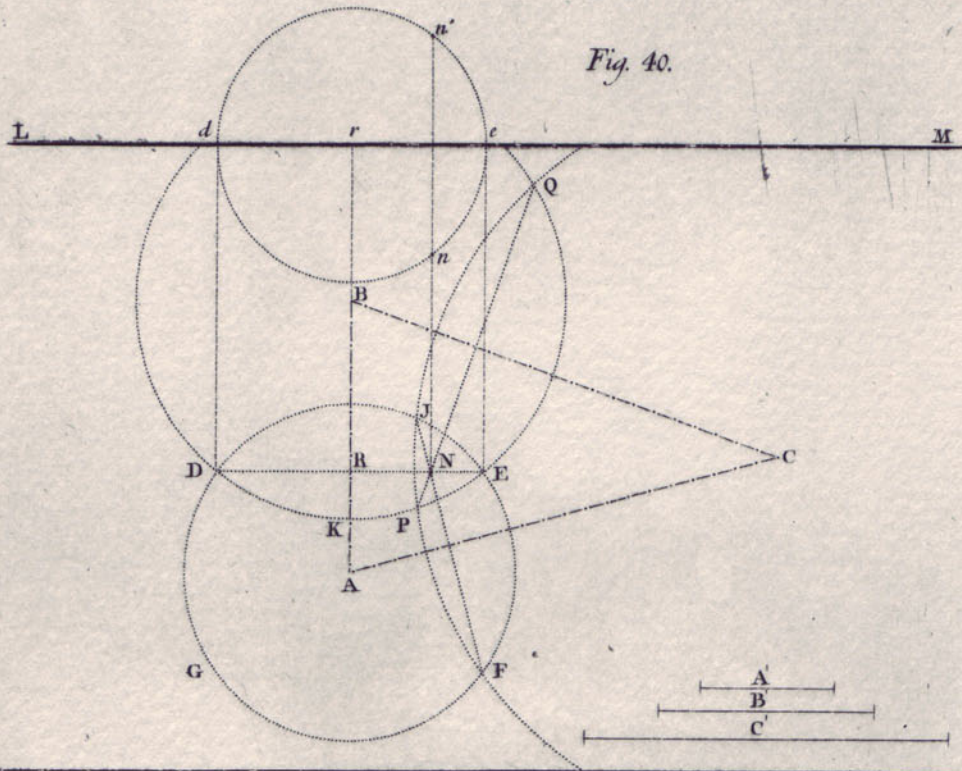

Fig. 40.

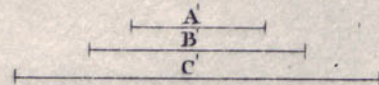
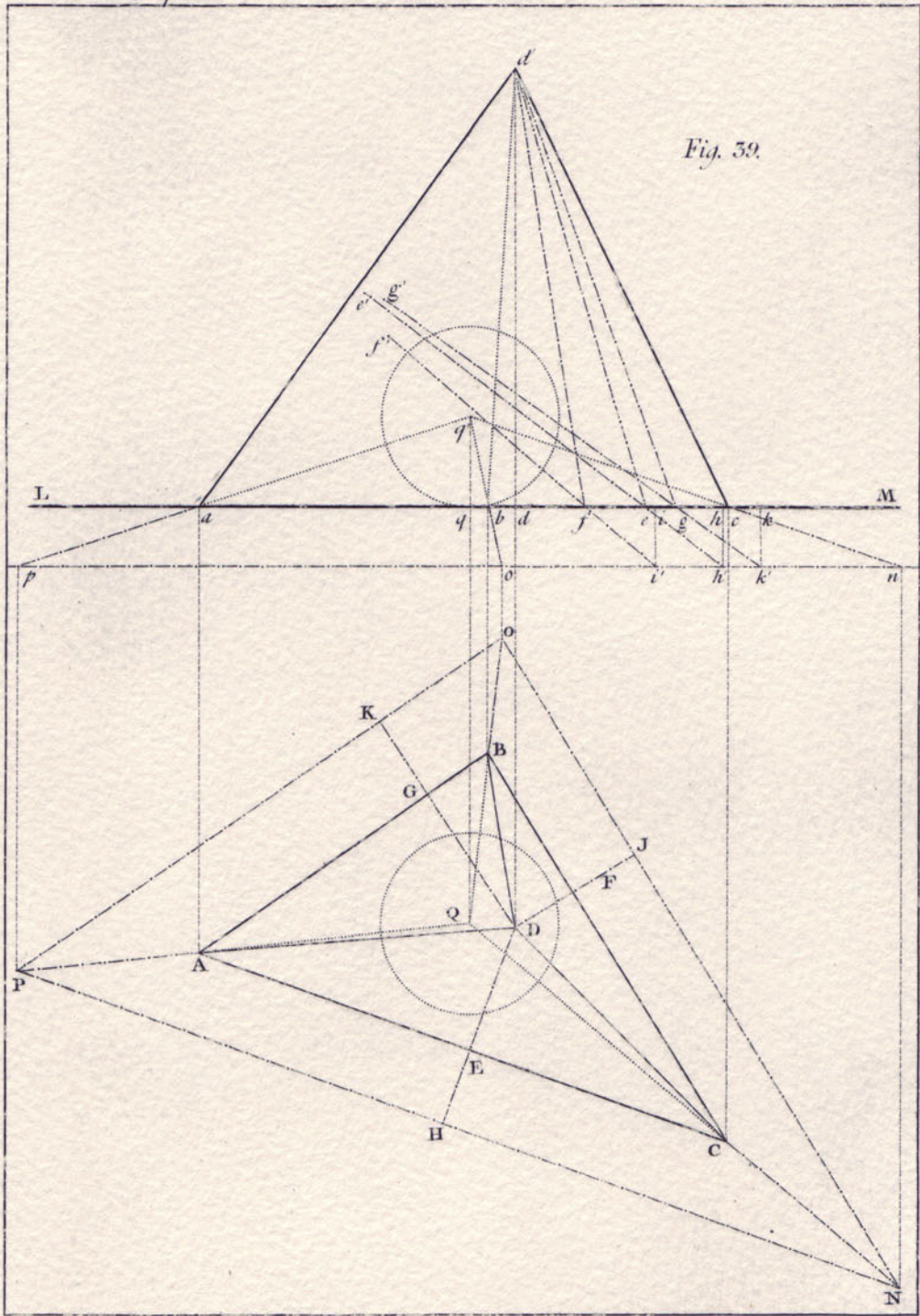

Fig. 39.



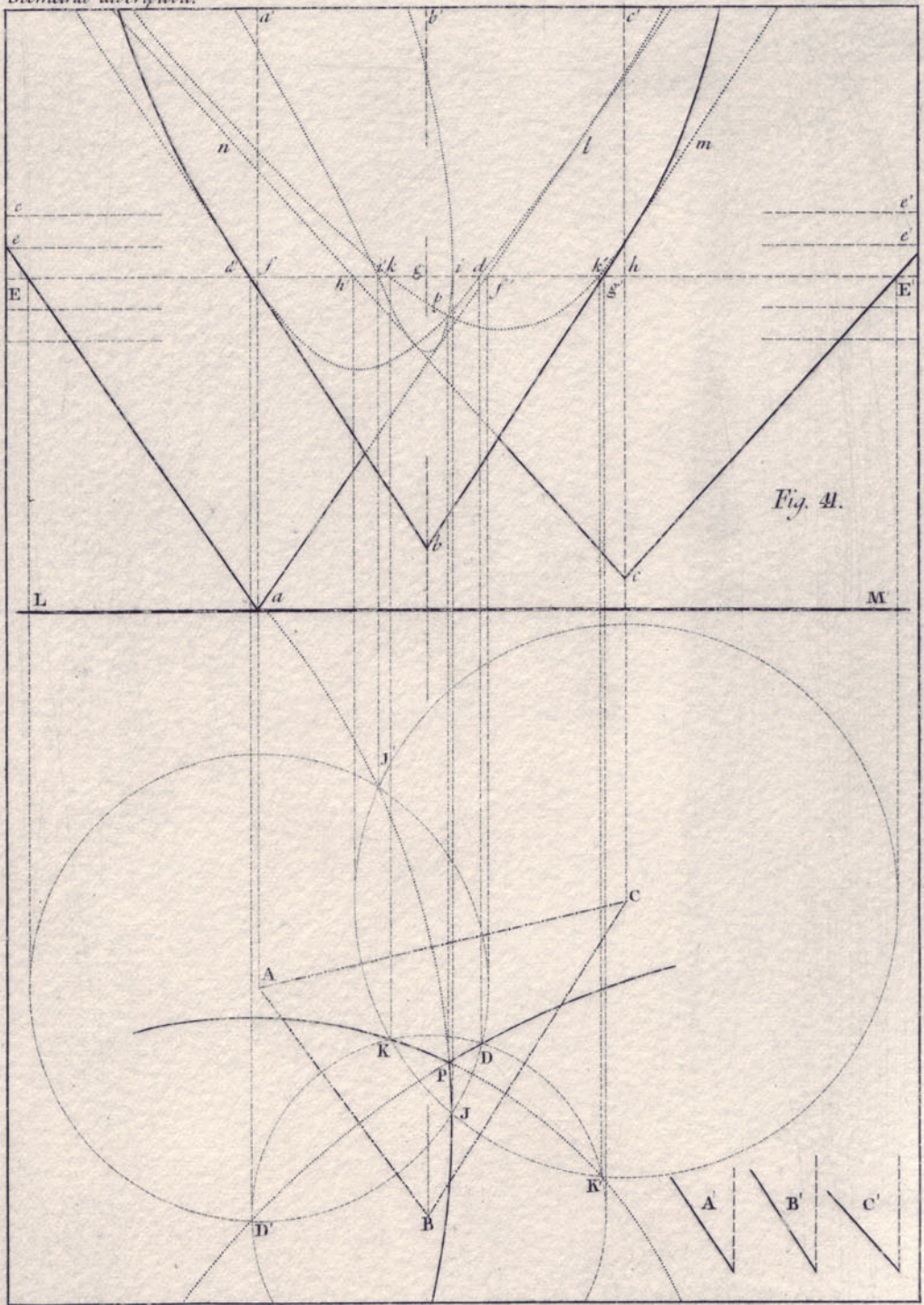
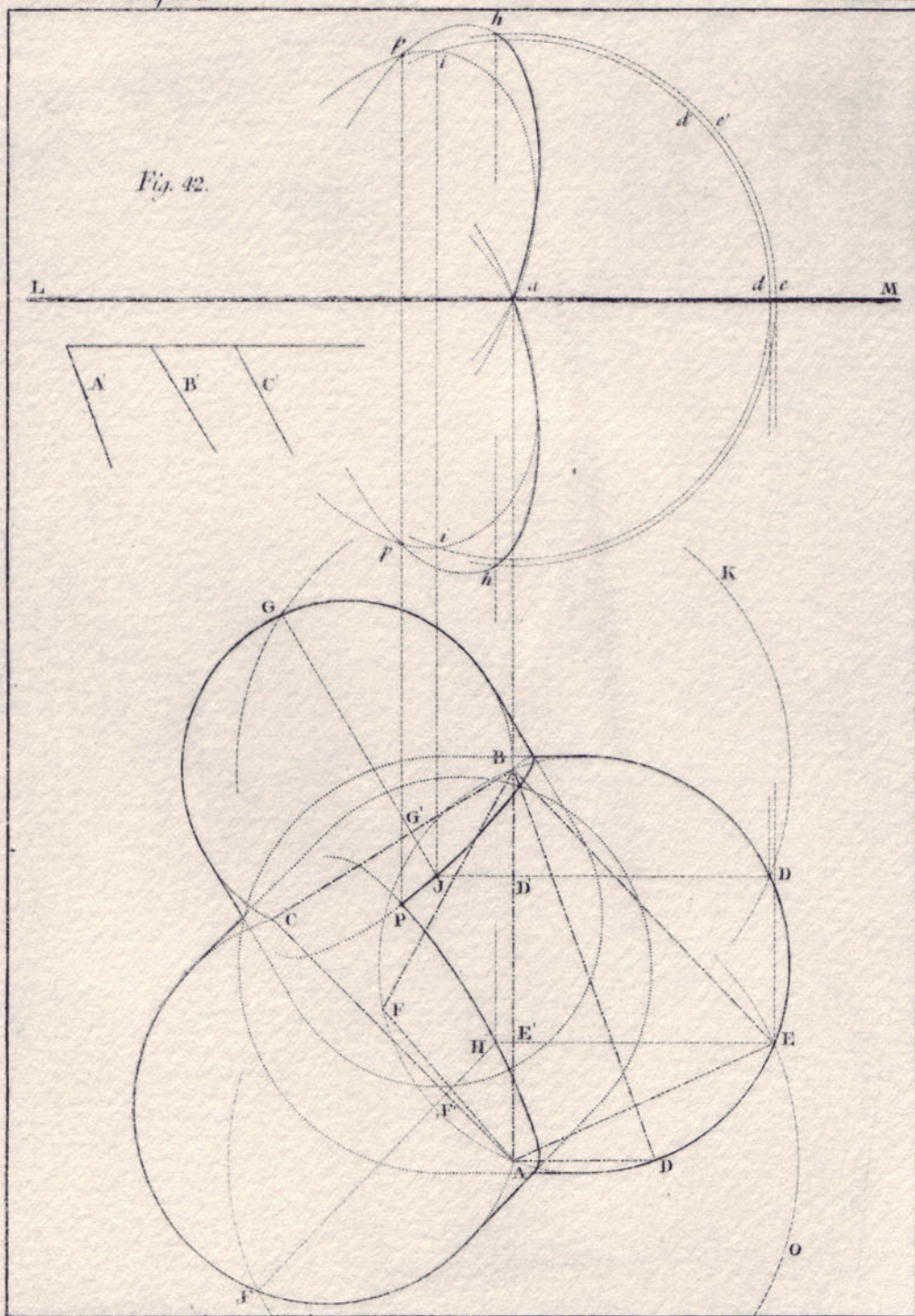

Fig. 41.

Fig. 42.



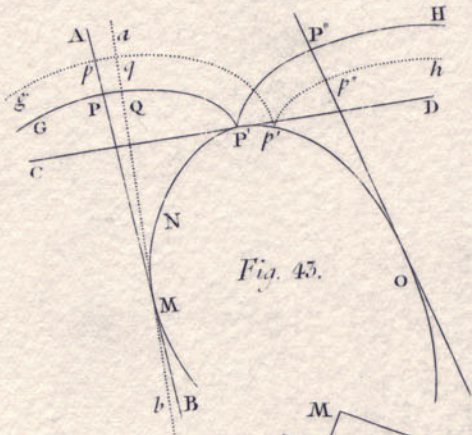

Fig. 44.

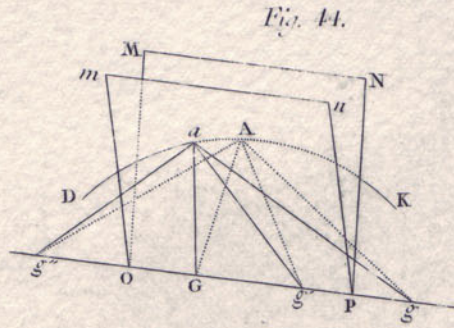

Fig. 45.

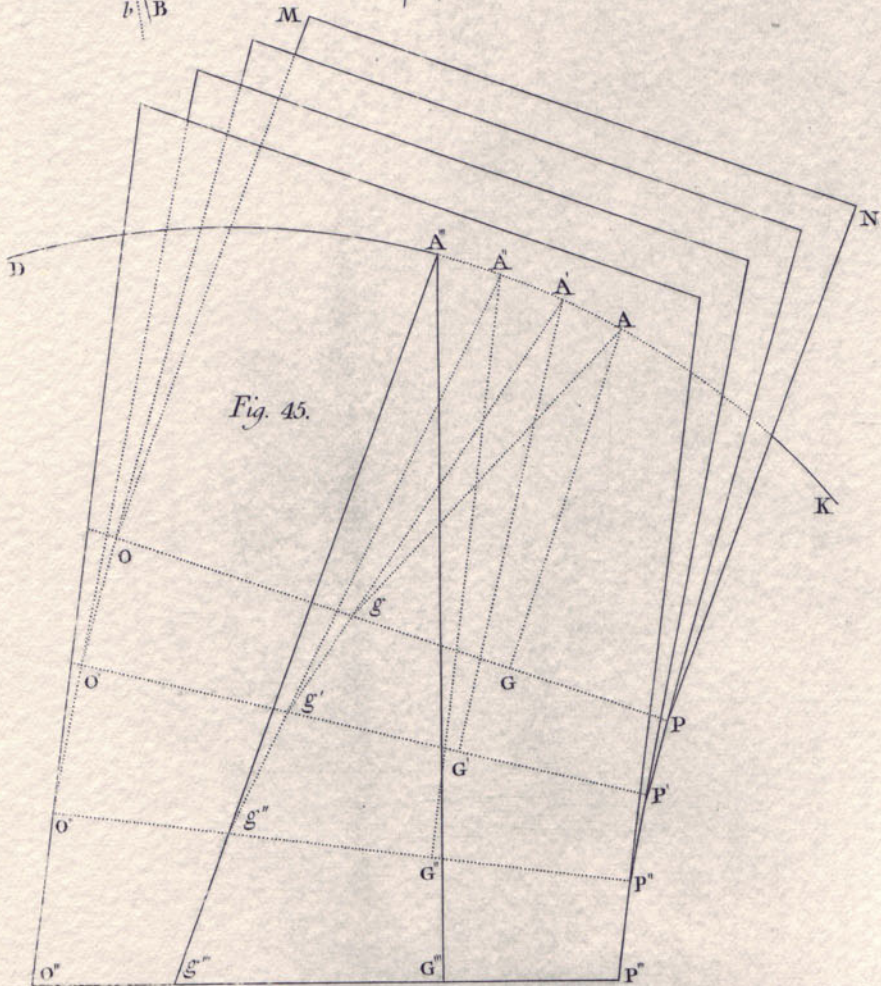

Fig. 45.

Fig. 46.

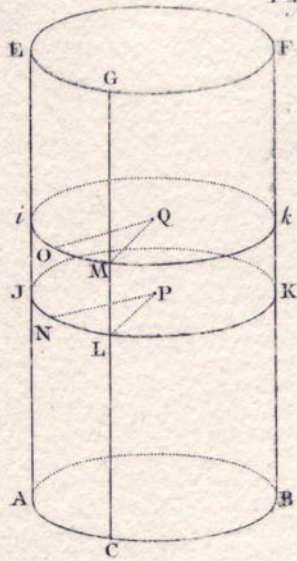

Fig. 47.

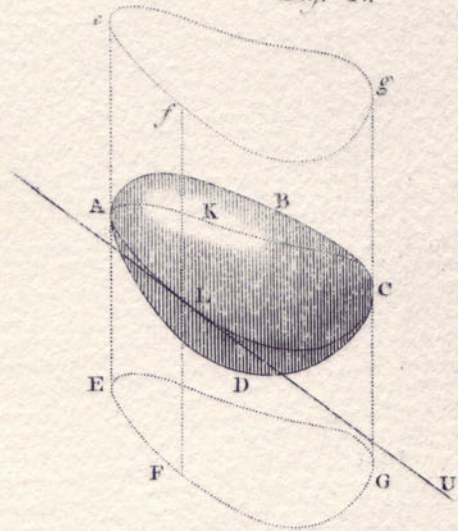

Fig. 48.

